



5 Day FDP on Application of Analytics in the areas of Management	
Date: 22 nd to 26 th June 2020	Venue: Zoom webinar
Time: 11 am to 1 pm	Event : Webinar
No. of Participant: 105	Event Coordinator: Dr. Santhosh M Prof. Reddy Prof Dileep Prof. Priya Jain
Objectives <ul style="list-style-type: none">- To gain deeper understanding of the world of Business Intelligence- To understand the concept of marketing analytics and apply the related to tools to solve marketing related problems.- To understand the concept of HR Analytics and apply some tools to demonstrate how analytics helps to solved HR related problems- To understand the concept of Operations analytics and applying some analytical tools to demonstrate how analytics helps in solving operations and supply chain related issues.- To understand the concept of finance analytics and how financial analytics helps to solve various financial issues.	
Agenda/Flow of the Event <ul style="list-style-type: none">• 22nd June- Introduction to the World of Business Intelligence• 23rd June- Marketing Analytics• 24th June- HR Analytics• 25th June- Operations Analytics• 26th June- Finance Analytics	
Outcome Achieved/ Attained: <ul style="list-style-type: none">- Dr Bung started the FDP on 22nd June with the introduction and importance of Business intelligence. He explained the difference between OLAP and OLTP. He briefly explained the architecture of business intelligence and how it works in real world scenario. He has also given	

overview of the concept of data mining.

- On the second day the resource person was Dr. Devesh Bathla and he introduced all to the concept of marketing analytics. He highlighted some examples of big data like genetics data, physics experiments and passively gathered data. He demonstrated what all things data can do in sports. He also took a data set of supermarket and explained how analytics can be applied there and can help to solve various complex problems.
- Third day the session was taken over by Mr. Prashant Ahuja. Initially he explained how human resource functions in an organization. He then focused on why HR/ people/ work force/ talent analytics is required. He explained that with the advancement of technology the old operational HR has been shifted to strategic and data driven HR. He also discussed the concept of Attrition analysis/ Churn Analytics.
- Fourth Day the session was held by Mr. Swapnil Soni. Mr Swapnil introduced to the concept of operations analytics and its challenges across industries. He discussed wonderful case study **Dynamic Decision Model For Cyclical Employee Scheduling**. Using the case study he explained how analytics can be used in solving the problem of making work roaster for employees working in different shifts.
- Last day of the program was taken over by Mr. Jishnu Mukherjee on the topic Finance Analytics. He explained the concept of credit risk analysis and explains the profit and loss of banks and credit card customer behavior. He also explained predictive modeling lifecycle. He used R tool and demonstrate how analytics helps in taking financial decisions.

Feedback & Coordinator Comment:

The entire program was very well received by all the participants. Everyone appreciated the efforts of all the resource persons and shown their interest to attend many more such sessions. Linking analytics with various management aspects and demonstrating the use of analytics to solve various management issued was the major take away for all the participants.

Event Coordinator(s)

N. N. S. (Prof. Nagasubba Reddy)

W. P. S. (Dr. Santhosh M)

A. K. S. (Prof. Dileep)

P. S. S. (Prof. Priya)



Director

Annexure 1	Proposal / Approval	Attached
Annexure 2	Circular / Brochure of the event	Attached
Annexure 3	Brief profile of the speaker	Attached
Annexure 4	Attendees list	Attached
Annexure 5	Photo Gallery	Attached
Annexure 6	Detail Feedback (if required)	attached
Annexure 7	Certificate copy	attached

Annexure 2
Circular / Brochure of the event

Brochure

 **RV Institute of Management**
Affiliated to Bangalore Central University
Approved by AICTE, New Delhi. Accredited by NAAC with 'A+' grade.



Go, change the world

Rashtreeya Sikshana Samithi Trust
R V Institute of Management
CA 17, 36th Cross, 26th Main, 4th 'T' Block, Jayanagar, Bangalore - 560 041
Ph: 080-26547048 Fax: 26654920 ; URL: rvim.edu.in ; Email: contact.rvim@rvei.edu.in

**5 DAY FDP
ON APPLICATION OF ANALYTICS
IN THE AREAS OF MANAGEMENT**

22nd June to 26th June- 2020
Timings- 11 am to 1 pm



Dr Purushottam Bung
Director & Professor
RV Institute of Management

**Introduction to the
World of Business
Intelligence**

Marketing Analytics

Dr Devesh Bathla
Industry Practitioner &
Professor of Analytics,
Chitkara Business School
Chitkara University, Punjab



Mr. Prashant Ahuja
Senior Analyst,
Global Leadership Hiring
India and United Kingdom

HR Analytics

Operations Analytics

Mr Swapnil Soni
Lead Business analyst,
Infosys Ltd



Mr Jishnu Mukherjee,
Senior Analyst at
Infosys Ltd.

Finance Analytics

Registration Fees: Academicians / Research Scholars/ Industry Participants: **Rs 500/-**
Students: **Rs 200/-**

Bank Details : Name: Director RV Institute of Management
Bank Name: ICICI Bank, 9th Block Branch, A/C No. : 029901002291
IFSC Code: ICIC0000299 MICR Code: 560229022

Registration link: <https://forms.gle/8emNcrPbqaserA11A>

For any queries contact us at businessanalyst.fdp2020@gmail.com

FDP COORDINATORS

Dr. Santhosh M, Prof. N Reddy, Prof. Dileep, Prof. Priya

Annexure 3

Brief profile of the speaker

Brief Profile of the Resources Persons

1. Dr Purushottam Bung, Professor and Director at RV Institute of Management



Dr. Purushottam Bung is an engineer with a rich experience of around 26 plus years in Academia and industry (domestic and international). He completed PGDM from Melbourne Business School, Australia, one of the top 10 B-schools in the world and MBA from Monash University, one of the top universities in the world. He has a rich entrepreneurial experience of around 10 plus years in the food processing industry. He is on the expert/advisory/editorial panel of many Institutions, Universities, NGOs and journals. Dr. Bung has presented and published 22 research articles in national and international refereed journals and undertaken several consultancy assignments. Dr. Bung was conferred with “Enterprising Academic Leader of the year (South India)” as part of National Education Excellence Awards in 2018. He was conferred with “Distinguished Educator” award in 2013. In 2015 he was awarded as ‘Best Director of a B-school in Karnataka’ as part of education excellence awards – 2015. He is member of many Associations and Institutional bodies. He is elected as FELLOW of World Academy of Productivity Sciences at Beijing, China recently. He is also a research fellow of Institute of Productivity, UK. Dr. Bung is offering management consultancy services to local Businesses, Institutions and entrepreneurs as well. Very recently he has completed a HarvardX course in collaboration with Pearson Global and Ureka Education group, UK on ‘Future of Learning’ anchored by Prof. Richard Elmore, Professor and authority in Education and Learning from Harvard.

**2. Dr. Devesh Bathla, Industry Practitioner & Professor of Analytics, Chitkara Business School
Chitkara University, Punjab**



- Dr. Devesh Bathla is a committed, knowledgeable and capable industry practitioner with 10+ years of experience in field of Business Analytics and passionate for corporate training and academia. He has over 10 years of experience providing analytical solutions to global clients from diverse domains of IT, BFSI, Health Care, Ed-Tech and more.
- A confident presenter and teacher, able to impart complex information to audiences of all levels. Worked with BCG, SAS, IBM on CLM projects.
- Dr. Devesh has designed and delivered curriculum on “Data Science Essentials” for UG/PG programs at Universities. Published two books with an international publishing house at Germany
- Dr. Devesh is Expert in Customer lifecycle management, Product management and Channel Sales.
- He is a proud recipient of TTSL Monthly Star Award , Spotlight Award, Young Star Award and Chairman Award

3. Mr Prashant Ahuja, Senior Analyst, Global Leadership Hiring, UK & India



- Prashant is a mid-career research and analytics service professional with >5 years of quasi-

consulting work experience.

- He has well-rounded professional experience spanning research engagements, management consulting, Human Resource consulting, big data analysis, leadership advisory and executive search.
- He enjoys working in multi-cultural environment and setting a new challenge every day. His four pillars for growth are learning, hard work, enthusiasm, and ownership

4. Mr. Jishnu M, Senior analyst, Data science, Infosys

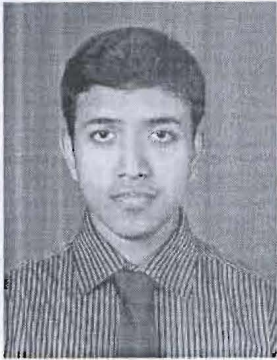

Jishnu has been associated with Data & Analytics industry for the past 6 years and currently works at Infosys Ltd as Senior Analyst. His work involves validation of credit risk and Fraud detection models for US retailers and financial institutions. He also has experience in delivering to several Fortune 500 companies on the problems around retail operations decision making, store operations optimization. Jishnu has teaching experience with different institutes and in online platforms and have delivered over 1000+ hours of training. He holds a PGDDS from IIIT-B and is well versed with using advanced coding practices and visualization tools and structures. He uses both R and Python for teaching data science. Jishnu's expertise is in time series modeling and is also experienced highly in using various supervised and unsupervised machine learning algorithms to solve real world complex business problems. His experience and ability to teach concepts for both the students at graduate level and working professionals effectively helps the audience to grasp and apply at their level.

5. Mr Swapnil, Lead Business Analyst, Infosys Ltd.



Swapnil Soni has been associated with Data & Analytics industry for the past 8 years and currently works at Infosys Ltd as Lead Analyst. His work involves validation of credit risk models for US banks, serving the purpose of bank's portfolio planning and regulatory compliance (CECL, CCAR and DFAST). He has delivered qualitative and quantitative assessment of econometric models, optimisation models along with proposals of challenger models for the performance improvement in retail operations just to name the highlights. His profile evinces diverse experience of teaching and project management. Swapnil started his career as a lecturer and session in-charge in an engineering institution and facilitated thermal and design subjects of mechanical engineering for a year. His contribution at TATA projects in waste reduction and process automation fetched him recognition from Tata Projects as well as Quality Circle Forum of India. Swapnil has earned Masters of Management in Business Analytics from Indian Institute of Science (IISc), Bangalore along with specialized courses from IIM-B and NIAS. He is currently pursuing PhD at IISc. He is highly experience in teaching complex concepts using simple methods.

Annexure 5 Photo Gallery

Dr. Dinesh Bathla is a research, knowledge-based and capable business professional with vast experience in the field of Strategic Analysis and planning for various business and industries. He has over 20 years of experience providing analytical solutions to global clients from various countries of IT, BFSI, Health Care, FMCG and more.

- Academic papers and articles on management strategy published in a number of all levels (ranked with UGC, SSC, IIM and IAS papers).
- Dr. Bathla has designed and delivered executive on Demand Service Courses on IIM/ITM programs in the various. Published two books: 628 on international publishing house in Chennai.
- Dr. Bathla is Expert in Technical Interview assessment, Project management and Client Sales.
- He is a past recipient of IISL, Monthly Star Award, Spotlight Award, Young Star Award and Business Award.



Dr. Dinesh Bathla
Industry Practitioner &
Professor of Analytics,
Chitkara Business School
Chitkara University, Punjab

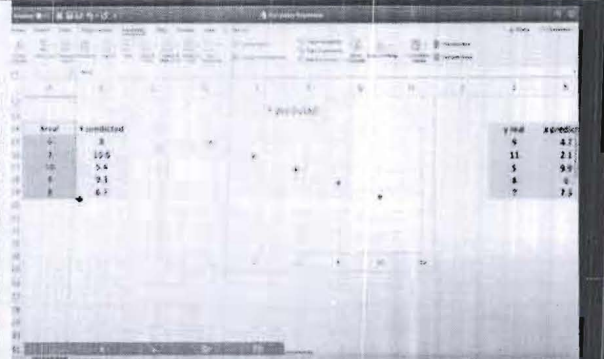

Year	X	Year	X
2	2	5	4.2
7	1.5	11	2.1
10	5.4	5	9.0
8	9.1	4	0
	6.7	7	7.5

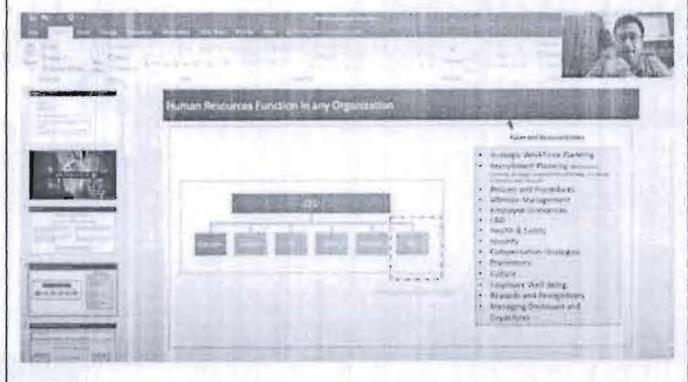
Human Resources Function in any Organization



Key HR Responsibilities:

- Strategic Workforce Planning
- Recruitment Planning
- Talent Development
- Payroll and Compensation
- Performance Management
- Employee Engagement
- HRIS
- Health & Safety
- Diversity
- Communication Strategy
- Organizational Design
- Employee Well-being
- Regulatory Compliance
- Rewards and Recognition
- Employee Discretion and Organization

Boosting Employees Safety and Wellbeing

Problem: Design a employee safety solution for people working in the factories to reduce accidents.

Technology Leveraged: IBM Watson's cognitive computing power and sensors in smart helmets and belts.

Data Analyzed: Worker Movement, Heart Rate, Temperature.

Solution: IBM Employee Wellness and Safety Solution, delivers safety alerts in **real time** to workers and supervisors. For example, if the technology detects a worker is **not moving** and they have an **increased heart rate and high temperature**, it could mean they're suffering from exertion or even extreme heat stress. In which case, a supervisor could be alerted, or the employee advised to take a break.

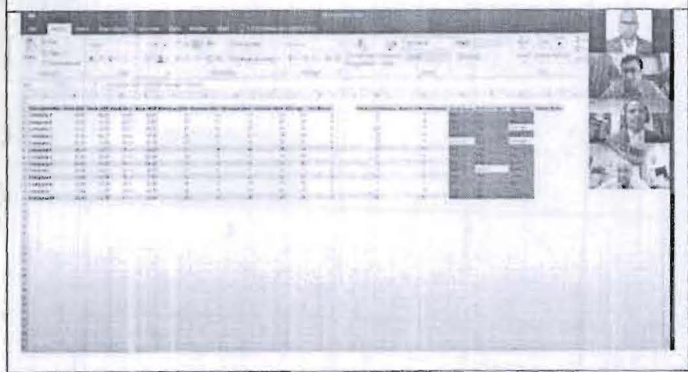



Industrial production: input, output & challenges

Input



→



Industry



Execution & Result

Month	1	2	3	4	5	6	7	8	9	10	11	12	13	14	15	16	17	18	19	20	21	22	23	24	25	26	27	28	29	30	31
Jan	1	2	3	4	5	6	7	8	9	10	11	12	13	14	15	16	17	18	19	20	21	22	23	24	25	26	27	28	29	30	31
Feb	1	2	3	4	5	6	7	8	9	10	11	12	13	14	15	16	17	18	19	20	21	22	23	24	25	26	27	28	29	30	31
Mar	1	2	3	4	5	6	7	8	9	10	11	12	13	14	15	16	17	18	19	20	21	22	23	24	25	26	27	28	29	30	31
Apr	1	2	3	4	5	6	7	8	9	10	11	12	13	14	15	16	17	18	19	20	21	22	23	24	25	26	27	28	29	30	31
May	1	2	3	4	5	6	7	8	9	10	11	12	13	14	15	16	17	18	19	20	21	22	23	24	25	26	27	28	29	30	31
Jun	1	2	3	4	5	6	7	8	9	10	11	12	13	14	15	16	17	18	19	20	21	22	23	24	25	26	27	28	29	30	31
Jul	1	2	3	4	5	6	7	8	9	10	11	12	13	14	15	16	17	18	19	20	21	22	23	24	25	26	27	28	29	30	31
Aug	1	2	3	4	5	6	7	8	9	10	11	12	13	14	15	16	17	18	19	20	21	22	23	24	25	26	27	28	29	30	31
Sep	1	2	3	4	5	6	7	8	9	10	11	12	13	14	15	16	17	18	19	20	21	22	23	24	25	26	27	28	29	30	31
Oct	1	2	3	4	5	6	7	8	9	10	11	12	13	14	15	16	17	18	19	20	21	22	23	24	25	26	27	28	29	30	31
Nov	1	2	3	4	5	6	7	8	9	10	11	12	13	14	15	16	17	18	19	20	21	22	23	24	25	26	27	28	29	30	31
Dec	1	2	3	4	5	6	7	8	9	10	11	12	13	14	15	16	17	18	19	20	21	22	23	24	25	26	27	28	29	30	31

No employee can have more than given allowable number of holidays in a fortnight.

Understanding the functionality of a bank

Primary Function of Bank

- Banking Transaction**
 - Savings account
 - Debit Cards
 - ATM Cash Withdrawals
- Loans**
 - Auto Loans
 - Educational Loans
 - Home Loans
 - Travel Loans
- Deposits**
 - Investment

Business Intelligence process

```

    graph LR
      A[Data Source] --> B[Data Preparation]
      B --> C[Data Warehousing]
      C --> D[Data Exploration]
      D --> E[Data Mining]
      E --> F[Reporting and Visualization]
  
```

Annexure 6

Detail Feedback (Attached) Day-1 Resource Person- Dr Purushottam Bung

Overall rating of the resource person considering command on the subject matter and delivery

58 responses

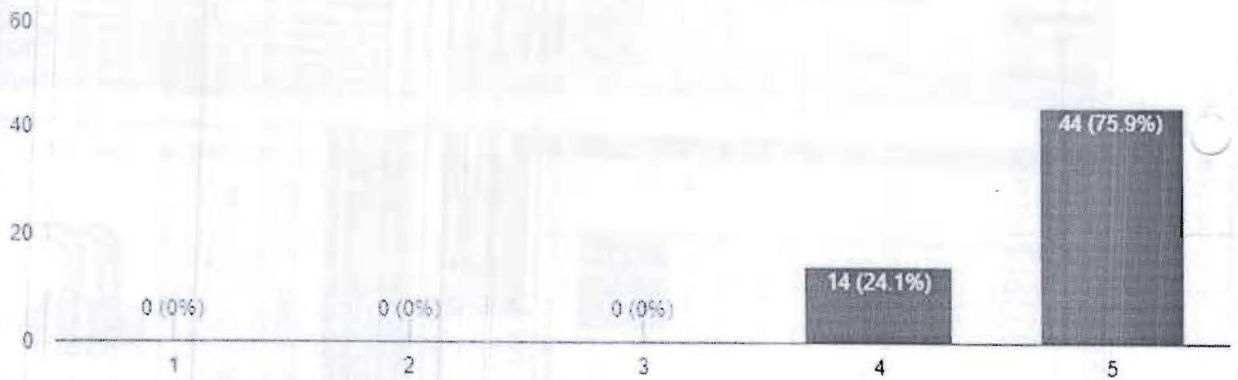

Overall rating on conduct of FDP

58 responses

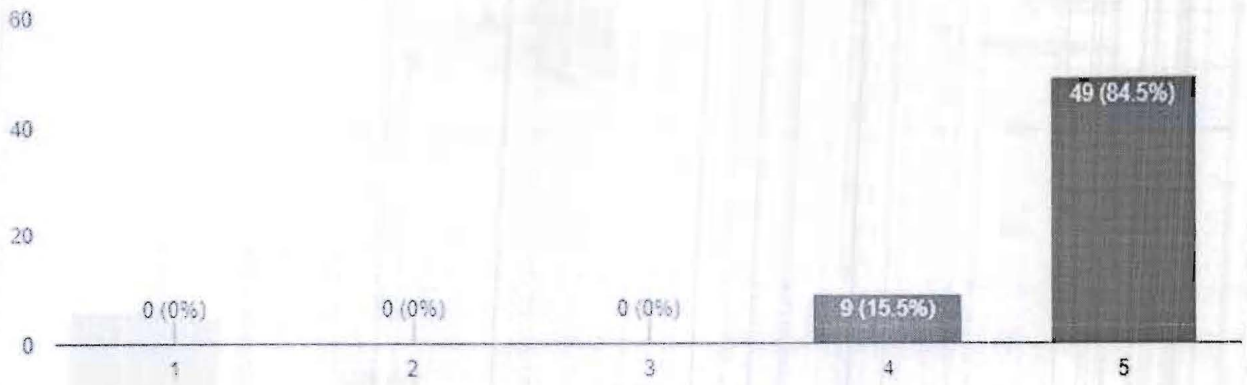

Day-2- Resource Person- Dr. Devesh Bathla

Overall rating of the resource person considering command on the subject matter and delivery

65 responses

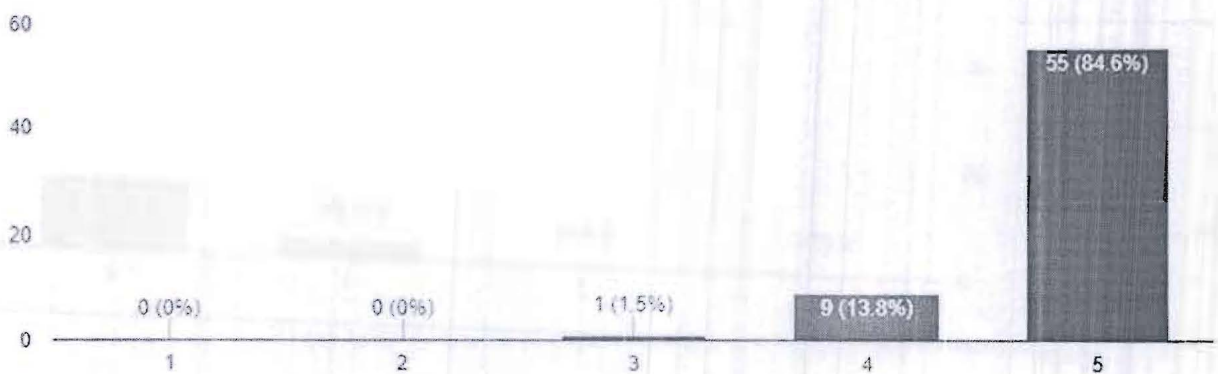

Overall rating on conduct of FDP

65 responses



Day- 3- Resource Person- Mr. Prashant Ahuja

Overall rating of the resource person considering command on the subject matter and delivery

66 responses

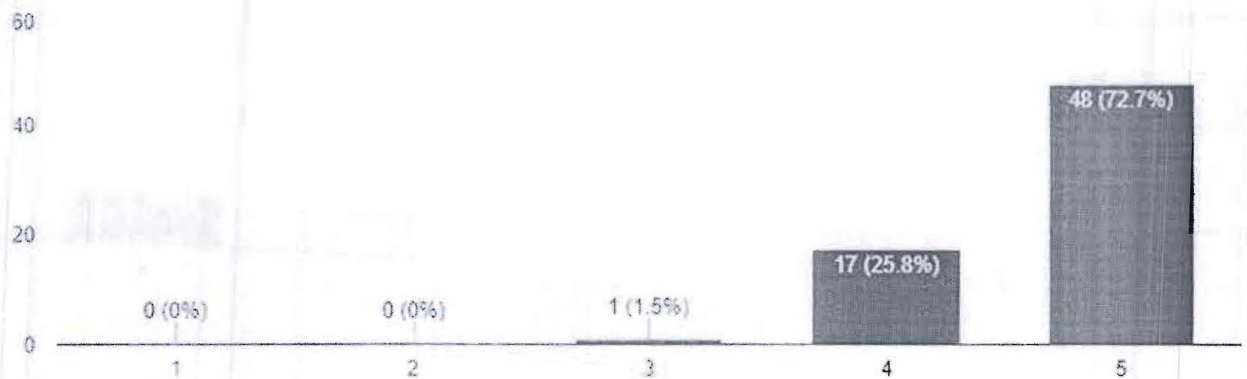

Overall rating on conduct of FDP

66 responses

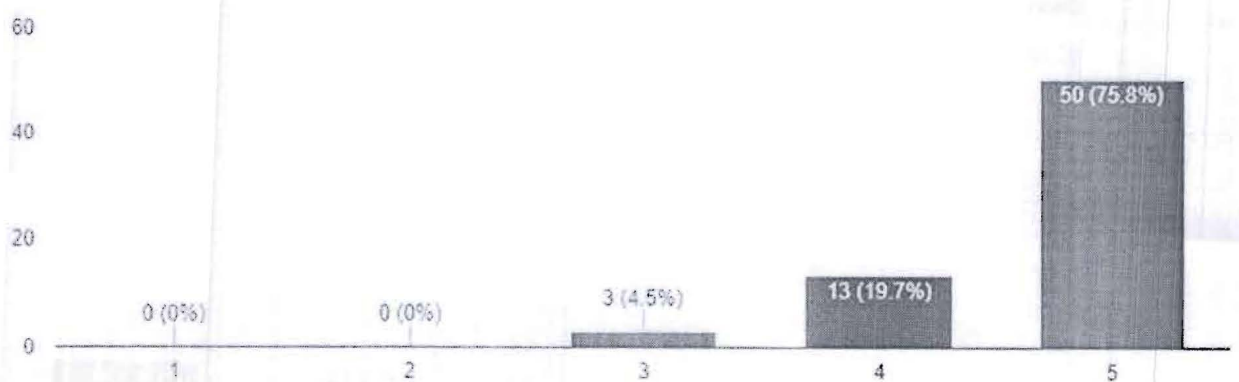

Day- 4- Resource Person- Mr Swapnil Soni

Overall rating of the resource person considering command on the subject matter and delivery

68 responses

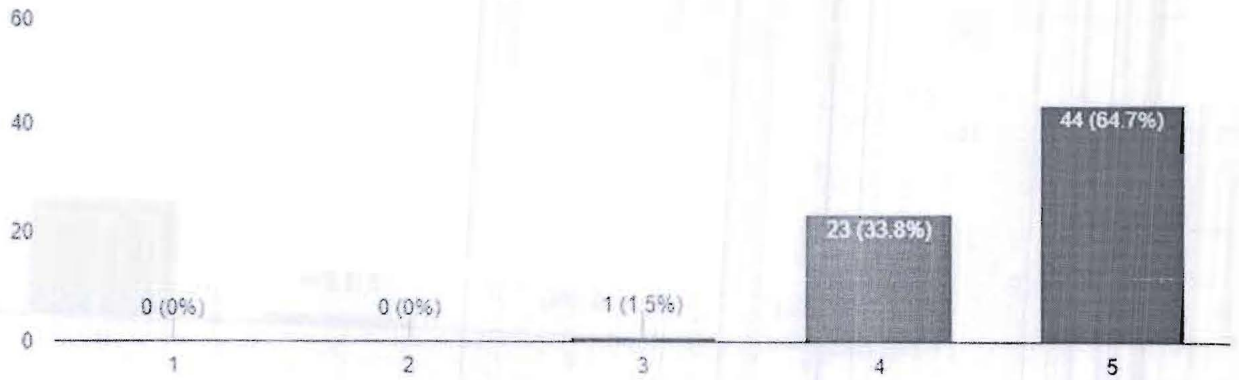

Overall rating on conduct of FDP

68 responses



Day- 5 Resource Person- Mr. Jishnu Mukherjee

Overall rating of the resource person considering command on the subject matter and delivery

71 responses

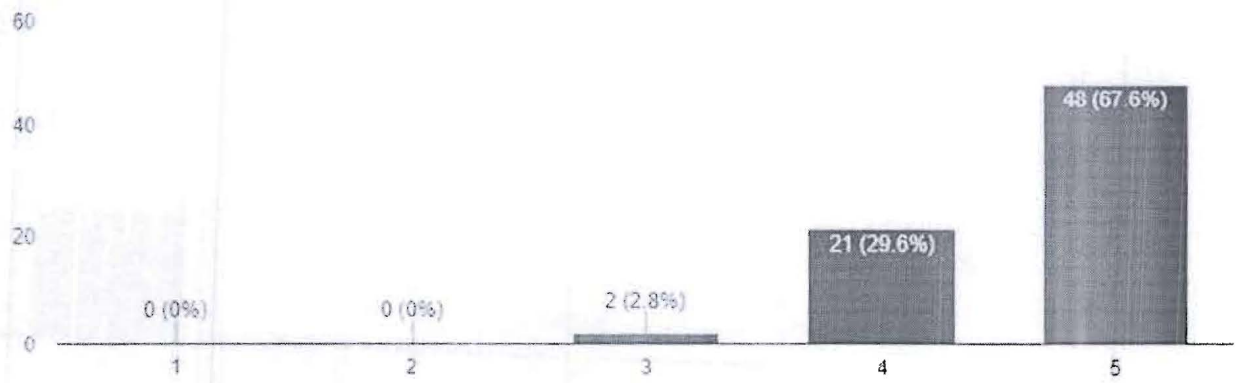

Overall rating on conduct of FDP

71 responses

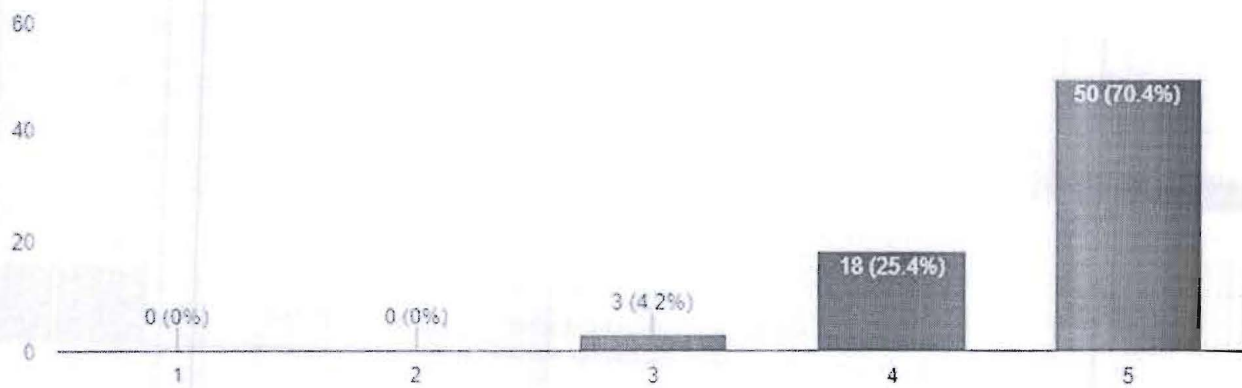

Annexure 7

Certificate Copy Attached

Attendance Sheet

	EMAIL ID	NAME	DESIGNATION	Institute	PHONE NO.
1	abhaypai2919@gmail.com	Abhay Pai	Student	RV Institute of Management, Bangalore	7483898039
2	adarsharuna4@gmail.com	ADARSH.B	Student	Pes institute	9380312041
3	akhileshnn555@gmail.com	Akhilesh N N	Designated Partner	Bhagawathi Trading LLP	9620024174
4	ankitadodabahl@gmail.com	Ankita Bahl	Lecturer	Surendera group of institutions sriganganagar Rajasthan	8290975996
5	sarpitha975@gmail.com	Arpitha s	Student	Rv institute of management	9739694599
6	arunvijaypillai@gmail.com	Arun Vijay	Research Scholar	Karpagam Academy of Higher Education	9447876424
7	avyakt.khandelwal@bba.christuniversity.in	Avyakt	Student	Christ University	7483293412
8	chethankumarb.rvim@rvei.edu.in	B.Chethan kumar	Student	Sinhgad Institute of Business Administration & Research (SIBAR)	8149203624
9	bharatchoudhary659@gmail.com	Bharat Choudhary	Student	RV INSTITUTE OF MANAGEMENT	8073836728
10	chandhangowda.s@gmail.com	Chandhan S			
11	rvtagarajan@gmail.com	CS Dr RV Tyagarajan	Visiting professor and comp	Sri Aurobindo College, MCC, Sartorius India Pvt.Ltd	9886108180
12	debasishghosh.rvim@rvei.edu.in	Debasish Gosh			
13	deepagshankar17@gmail.com	Deepa G	Research Analyst	Thomson Reuters	7411901914
14	girish.mude@mitwpu.edu.in	Dr Girish Mude	Assistant Professor	MIT World Peace University, Pune, India	9822640685
15	vandanamohanty7@gmail.com	Dr Vandana Mohanty	Assistant Professor	Yashaswi's IIMS	9657096854
16	aljoseph@kch.amity.edu	Dr. Ansted Iype Joseph	Assistant Professor	Amity Global Business School, Kochi	9895251104
17	chaudharianupama@gmail.com	Dr. Anupama Chaudhari	Assistant Professor	KCE's Institute of Management and Research, Jalgaon	9881376212
18	balablooms@gmail.com	Dr. Balaji D	Project Manager, Digital Media Content Services	Elsevier India Pvt. Ltd.	9943088999
19	harshkothari76@gmail.com	Dr. Harsh Vardhan Kothari	Professor	Delhi Institue of Advanced Studies	9312263310
20	moirangthem.roshini@gmail.com	Dr.Moirangthem Roshini	Assistant Professor	Manipur Technical University	09856317429
21	shalini.shalu164@gmail.com	Dr. Shalini H S	Assistant Professor	Acharya Bangalore B-School	6361615843
22	dr.vinaykpune@gmail.com	Dr. Vinay Kumar	Associate Professor	Chandigarh University	8983020882
23	narasimavenkatesh.rvim@rvei.edu.in	Dr.A.Narasima Venkatesh			
24	lubnaambreen27@gmail.com	Dr.Lubna Ambreen	Asst. Professor	CMS BUSINESS SCHOOL, JAIN DEEMED-TO-BE UNIVERSITY	9742806085
25	radhi3sree@yahoo.co.in	Dr.P.V.Radhika	Assistant Professor	TSR & ERR Government Degree College	9849449735
26	prathiba.l@mitwpu.edu.in	Dr.Prathiba.L	Assistant Professor	MIT World Peace University	9850824290
27	ranjithsc2016@gmail.com	Dr.Ranjith Somasundaran Chakkambath	Asst Professor Operations	AMITY Global Business School Kochi	9496864249
28	simeonsimon2009@gmail.com	Dr.SIMEON S SIMON	Associate Professor	St Francis Institute of management and Research	6382347731

29	vikramadk@jnnce.ac.in	Dr. Vikrama D K	Assistant Professor	MBA, JNN College of Engineering, Shimoga	9449174652
30	evani.cmon@gmail.com	Evani Pattnaik	Assistant Professor	Trident Academy of Creative Technology, Bhubaneswar	9853769717
31	princessfredy42@gmail.com	Fredisha K Maben	Student	RV institute of management	7022587109
32	mailme.nganesh@gmail.com	GANESH.N	Student	Seshadripuram college	8951977456
33	guruduttshenoy@gmail.com	Gurudutt Shenoy	Adjunct Faculty	R V Institute of Management	9591722825
34	kushwaha.hemant2@gmail.com	HEMANT KUSHWAHA	Research Scholar	Shri Mata Vaishno Devi University	9582799571
35	ishasetia94@gmail.com	Isha Setia	Lecturer	Surendera group of institutions sriganganagar	9871462138
36	jagratikamble@gmail.com	JAGRATI KAMBLE	Lecturer	JGND Bharatesh college of commerce and science	8105691508
37	kssubashmails@gmail.com	K S SUBASH	Asst. Professor	Brindavan Group of Institution	9740488557
38	karnati.saketh@gmail.com	KARNATI SAKETH REDDY	Research Scholar	Dayananda Sagar University	9482193829
39	7karthik.m@gmail.com	Karthik M	Student	RV Institute of Management	9900741401
40	kiranghiremath@gmail.com	Kiran Hiremath	Assistant Professor	Presidency College	9886335383
41	kirankvknet@gmail.com	Kiran Kumar K V	Faculty - Finance & Analytics	FRED	+919964402318
42	kirankumar012395@gmail.com	Kiran kumar	MBA	RVIM	8867398393
43	lakshmi.kashyap@outlook.com	Lakshmi Kashyap	Business Analyst	SF Works	09620196372
44	lavanya.hgowda@gmail.com	Lavanya	Finance , Analytics	RV institute of management	8618069247
45	preetibhite@gmail.com	LEELAVATI B THITE	Student	RV INSTITUTE OF MANAGEMENT	7204334809
46	maheshas2694@gmail.com	Mahesha.S	Student	RV INSTITUTE OF MANAGEMENT	8861573232
47	mamthagaonkar123@gmail.com	Mamatha Bhaskar Gaonkar	Student	RVIM	9739027690
48	manasarnreddy98@gmail.com	Manasa r n	Student	Maharani's cluster university	9886316711
49	manidatta.ray@bgu.ac.in	MANIDATTA RAY	ASST. PROFESSOR	BIRLA GLOBAL UNIVERSITY (BGU) ,BHUBANESWAR	9437250083
50	anithareddyani204@gmail.com	Mattamalam Anitha	Student	RV INSTITUTE OF MANAGEMENT	08884344288
51	mmeerababu@gmail.com	Meera b	Lecturer	Sjrc	9916875501
52	moheetmaurya.cuharyana@gmail.com	Moheet Maurya	Student	Central University of Haryana	6376473919
53	mohinishukla76@gmail.com	MOHINI SHUKLA	Assistant Professor	Earlier working in Shambhunath Institute of Managemnet	7905426341
54	ramamurari@gmail.com	N Ramamurari Naidu	Founder & CEO	Maleotech Solutions Pvt Ltd	9632411005
55	narayanasrikanthreddy@gmail.com	N Srikanth Reddy	Consultant	SRI Consulting	6364426363
56	Rahari2111@gmail.com	Narahari k k	Student	RV INSTITUTE OF MANAGEMENT	9901730946
57	naveen.kle.hbl@gmail.com	Naveen Kulkarni	Senior Systems Analyst	Sonata Software	8105093456
58	nidhi.natarajan@gmail.com	Nidhi Shridhar Natrajan	Assistant Prof.	SCMS, NOIDA	9810595386
59	nikitalohi49@gmail.com	Nikita L	Student	RV Institute of Management Bangalore	8762568272
60	niranjan.daddikar@gmail.com	Niranajan Daddikar	Lecturer	KLE's CBALC	9886437515
61	mankani.padma@gmail.com	Padma B Mankani	Professor	KLE's College of Business Administration, Belagavi	+917899170106
62	pannagahnhdse@gmail.com	Pannaga H.N	Student	RVIM	7204878821
63	poojahadimani02@gmail.com	Pooja Hadimani	Lecturer	KLE's CBALC	7204249201
64	preemadessa@gmail.com	Preema Dsa	Assistant Professor	Malleswaram Ladies Association First Grade College for Women	09480758394
65	priyankamurthyv29@gmail.com	Priyanka V Murthy	Student	RV Institute of Management	9591779785
66	ranaikathani@gmail.com	Prof. Ramachandra A Naik.	Asst. Prof	Shri K A Lokapur A/S/C College, Athani.	9620118685

67	rahulnairrk3@gmail.com	Rahul nair H	Student	RV institute of management	8947960409
68	rahulrohith32@gmail.com	RAHUL ROHITH	Student	Seshadripuram degree college	9036348083
69	rairajeshkumar1961@gmail.com	Rajesh Kumar Rai	Director	Bangalore Paints Pvt. Ltd	9845004181
70	v.rakesh71094@gmail.com	Rakesh N	Assistant Professor	Presidency College	8553640492
71	rameshcdu@gmail.com	Ramesh Chandrahas	Student	Institute of Management Studies, Davanagere University	8197680260
72	ramyas.rvim@rvei.edu.in	Ramya S			
73	ranjupk05@gmail.com	Ranjitha P K	Asst professor	Krupanidhi college of commerce and management, Koramangala,Bangalore	08105549070
74	krishnasuman83@gmail.com	S.K.Suman	Research Scholar	Amity University	9675302535
75	sagardesai4118@gmail.com	Sagar M Desai	Student	RV Institute of Management, Bangalore	9972995904
76	saranibhaumik1982@gmail.com	Sarani Bhaumik	Faculty	MAKAUT, WB	8027834501
77	shalique.cuharyana@gmail.com	Shalique Jawed Ansari	Student	Central University of Haryana	9883517086
78	hegadesheelaa@gmail.com	Sheela hegde	Student	RV Institute of management	9663695543
79	shijisharwankumar@gmail.com	Shijimol EA	Faculty member	International School of Management Excellence	9606509764
80	maneshivanivmane@gmail.com	Shivani V Mane	Senior Consultant	Aplica Technologies India Pvt Ltd	8884080327
81	search4shivassp@gmail.com	Shivaprasad DR	Student	RV institute of management	8105885854
82	shettyshravya1996@gmail.com	Shravya S Shetty	Student	RV Institute of Management	9867151007
83	shreyadeshpande1998@gmail.com	Shreya Satish Deshpande	Student	RV Institute of Management	8867220512
84	shahapurkar.shreya123@gmail.com	Shreya Shahapurkar	Student	R V institute of Management	8867145075
85	shubhamcbalc@gmail.com	shubham kusane	Kusane	Kle Cbalc	7019348339
86	sowjanyaabhatb1997@gmail.com	Sowjanya Bhat B	Student	R V Institute of Management	8970115118
87	sowmyads.rvim@rvei.edu.in	Sowmya D S		RVIM	
88	Accounts.rvim@rvei.edu.in	Sridhara H R			
89	srinidhipatawari901@gmail.com	Srinidhi B Patawari	Student	RV Institute of Management	8088177419
90	srivalli21gupta@gmail.com	Srivalli N Guptha	Student	Rvim	9845869343
91	sumanth99sharma@gmail.com	Sumanth O R	Student	RV Institute of Management	9481535704
92	sunilmantree@gmail.com	Sunilkumar R Hiremath	Associate Professor and Pla	Dr.D.Veerendra Heggade nstitute of Management Studies and Research Dharwad	9945903072
93	suparnalagamannavar7@gmail.com	Suparna Lagamannavar	Lecturer	JGND Bharatesh collage of commerce Belagavi	7892942760
94	mas.suraj@gmail.com	Suraj Muthu	Student	R.V Institute of Management	6361333581
95	sushbhat101098@gmail.com	Sushma Bhat K	Student	RV Institute Of Management	7795043804
96	sushmaherur@gmail.com	Sushma Heroorkar	Student	RV institute of management	9740895309
97	swatikashyab22@gmail.com	Swati Kumari	Student	RV Institute of Management	8880311183
98	lahsinhadalge98@gmail.com	Tahsin Hadalge	Student	RV institute of management	7204739139
99	tanzeelahmed395@gmail.com	Tanzeel Ahmed	Student	RV institute of management Bangalore	09041652535
100	tejashreebhat0027@gmail.com	Tejashree Bhat	Student	R V Institute Of Management	9482186292
101	tejashwini.shivu29@gmail.com	Tejashwini S	Student	RV Institute of Management	9945727583
102	thanikaathirstaraj@gmail.com	Thanika Devi A	Student	RV institute of management	8637476471
103	thejasvinitk@gmail.com	Thejasvi N	Student	R V Institute of Management	9738663055
104	timmareddy834@gmail.com	Timmareddy	Student	RV Institute Of Management	8618869278
105	vvijaya@blr.amity.edu	V Vijaya	Assistant Professor	Amity Global Business School	9731479479

106	veervai bhav@gmail.com	Vaibhav Prakash Veeragoudar	Assistant Professor	KLE Dr. M S Sheshgiri college of Engineering and Technology	+19972200334
107	vgangappanavar@gmail.com	Vishwanath B Gangappanavar	Student	RV Institute of Management	9036688095



RV Institute of Management®

Approved by AICTE, New Delhi. Accredited by NAAC with A+ grade. Affiliated to Bengaluru Central University.

*Go, change
the world*



Rashtreeya Sikshana Samithi Trust

R V Institute of Management

CA 17, 36th Cross, 26th Main, 4th T'Block, Jayanagar, Bangalore – 560041

Ph: 080-26547048 Fax: 26654920; URL: rvim.edu.in Email: contact.rvim@rvei.edu.in

E-CERTIFICATE

This is to certify,

CS Dr RV Tyagarajan

Visiting professor and company secretary in emp, Sri Aurobindo College, MCC, Sartorius India Pvt.Ltd

has successfully participated in **5 Days FDP** on 'Application of Business Analytics in the areas of Management' organized by R V Institute of Management, Bangalore from 22nd to 26th June, 2020.

Dr. Purushottam Bung
Professor and Director
R V Institute of Management

Vision : To Become World Class Management Institute of Eminence



**RV Institute of
Management®**

Approved by AICTE,
New Delhi. Accredited
by NAAC with 'A+' grade.

Affiliated to Bengaluru
Central University.

*Go, change
the world*

Rashtriya Sikshana Samithi Trust

R V Institute of Management

CA 17, 36th Cross, 26th Main, 4th 'T' Block, Jayanagar, Bangalore – 560 041

Ph: 080-26547048 Fax: 26654920; URL: rvim.edu.in Email: contact.rvim@rvei.edu.in



E-CERTIFICATE

This is to certify,

Arun Vijay

Research Scholar, Karpagam Academy of Higher Education

has successfully participated in **5 Days FDP** on 'Application of Business Analytics in the areas of Management' organized by **R V Institute of Management**, Bangalore from 22nd to 26th June, 2020.

Dr. Purushottam Bung
Professor and Director
R V Institute of Management



RV Institute of Management®

Approved by AICTE,
New Delhi. Accredited
by NAAC with A+ grade. Affiliated to Bengaluru
Central University.

*Go, change
the world*

Rashtriya Sikshana Samithi Trust

R V Institute of Management

CA 17, 36th Cross, 26th Main, 4th 'T'Block, Jayanagar, Bangalore – 560 041

Ph: 080-26547048 Fax: 26654920; URL: rvim.edu.in Email: contact.rvim@rvei.edu.in



E-CERTIFICATE

This is to certify,

Dr. Ansted Iype Joseph

Assistant Professor, Amity Global Business School

has successfully participated in **5 Days FDP** on 'Application of Business Analytics in the areas of Management' organized by **R V Institute of Management**, Bangalore from 22nd to 26th June, 2020.

Dr. Purushottam Bung
Professor and Director
R V Institute of Management

Attendee Report
Report Generated:

9/23/2020 11:22

Topic	Webinar ID	Actual Start Time	Actual Duration (minutes)	# Registered	# Cancelled	Unique Viewers	Total Users	Max Concurrent Views	
5 Days FDP on Application of Analytics in the Areas of Management									
Panelist Details	973 3430 1732	6/22/2020 10:37		156	107	0	97	256 96	
Attended	User Name (Original	Email	Join Time	Leave Time	Time in Session	Country/Region Name			
Yes	Prof NNS Reddy	nnsreddy.rvim@rvei.edu.	6/22/2020 10:39	6/22/2020 13:12	153	India			
Yes	Prof Dileep	dileep.rvim@rvei.edu.in	6/22/2020 10:37	6/22/2020 13:12	155	India			
Yes	Dr. Devesh Bathla	devesh.bathla@chitkara.	6/22/2020 10:56	6/22/2020 13:12	137	India			
Yes	Dr. Purushottam Bun drbung	rvim@rvei.edu.in	6/22/2020 10:37	6/22/2020 10:38	1	India			
Yes	Dr. Purushottam Bun drbung	rvim@rvei.edu.in	6/22/2020 10:40	6/22/2020 13:10	150	India			
Attended	User Name (Original	First Name	Last Name	Email	Registration Ti	Approval Status	Join Time	Leave Time	Time in Ses Country/Re
Yes	Preema Dsa	Preema	Dsa	preamadessa@gma	#####	approved	#####	#####	112 India
Yes	Anupama Chaudhari	Anupama	Chaudhari	chaudharianupama	#####	approved	#####	#####	5 India
Yes	Anupama Chaudhari	Anupama	Chaudhari	chaudharianupama@gmail.com	#####	#####	#####	#####	9 India
Yes	Anupama Chaudhari	Anupama	Chaudhari	chaudharianupama@gmail.com	#####	#####	#####	#####	124 India
Yes	Anupama Chaudhari	Anupama	Chaudhari	chaudharianupama@gmail.com	#####	#####	#####	#####	3 India
Yes	Anupama Chaudhari	Anupama	Chaudhari	chaudharianupama@gmail.com	#####	#####	#####	#####	4 India
Yes	Anupama Chaudhari	Anupama	Chaudhari	chaudharianupama@gmail.com	#####	#####	#####	#####	1 India
Yes	Anupama Chaudhari	Anupama	Chaudhari	chaudharianupama@gmail.com	#####	#####	#####	#####	26 India
Yes	Anupama Chaudhari	Anupama	Chaudhari	chaudharianupama@gmail.com	#####	#####	#####	#####	28 India
Yes	Anupama Chaudhari	Anupama	Chaudhari	chaudharianupama@gmail.com	#####	#####	#####	#####	1 India
No	Priyanka V	Priyanka V	Murthy	priyankamurthyv29	#####	approved	--	--	--
Yes	Rakesh N	Rakesh	N	v.rakesh71094@gm	#####	approved	#####	#####	2 India
Yes	Rakesh N	Rakesh	N	v.rakesh71094@gmail.com	#####	#####	#####	#####	44 India
Yes	Rakesh N	Rakesh	N	v.rakesh71094@gmail.com	#####	#####	#####	#####	84 India
Yes	Dr.Praharaju Venkat	Dr.Praharaju	Venkata Radhika	radhi3sree@yahoo.	#####	approved	#####	#####	130 India
Yes	Manju N	Manju	N	manjunathn.rvim@	#####	approved	#####	#####	81 India
Yes	Manju N	Manju	N	manjunathn.rvim@rvei.edu.in	#####	#####	#####	#####	15 India
Yes	Manju N	Manju	N	manjunathn.rvim@rvei.edu.in	#####	#####	#####	#####	2 India
Yes	Chandhan S	Chandhan	S	chandhangowda.s@	#####	approved	#####	#####	141 India
Yes	Abhay Pai	Abhay	Pai	abhaypai2919@gm	#####	approved	#####	#####	6 India
Yes	Abhay Pai	Abhay	Pai	abhaypai2919@gmail.com	#####	#####	#####	#####	54 India
Yes	Abhay Pai	Abhay	Pai	abhaypai2919@gmail.com	#####	#####	#####	#####	83 India
Yes	Moheet Maurya	Moheet	Maurya	moheetmaurya.cuh	#####	approved	#####	#####	4 India
Yes	Moheet Maurya	Moheet	Maurya	moheetmaurya.cuharyana@gmail.com	#####	#####	#####	#####	117 India
Yes	Tahsin Hadalge	Tahsin	Hadalge	tahsinhadalge98@g	#####	approved	#####	#####	34 India
Yes	Tahsin Hadalge	Tahsin	Hadalge	tahsinhadalge98@gmail.com	#####	#####	#####	#####	2 India
Yes	Tahsin Hadalge	Tahsin	Hadalge	tahsinhadalge98@gmail.com	#####	#####	#####	#####	1 India
Yes	Tahsin Hadalge	Tahsin	Hadalge	tahsinhadalge98@gmail.com	#####	#####	#####	#####	15 India
Yes	Rudhi Natarajan	Rudhi	Natarajan	rudhi.natarajan@g	#####	approved	#####	#####	140 India
Yes	Ramesh Chandra	Ramesh Chandra	Ramesh Chandra	rameshchandra@gmail	#####	approved	#####	#####	141 India
Yes	Ramesh Chandra	Ramesh Chandra	Ramesh Chandra	rameshchandra@gmail	#####	approved	#####	#####	1 India

Attendee Report
 Report Generated: 9/23/2020 11:26

Topic	Webinar ID	Actual Start Time	Actual Duration (minutes)	# Registered	# Cancelled	Unique Viewers	Total Users	Max Concurrent Views	
5 Days FDP on Application of Analytics in the Areas of Management	973 3430 1732	6/24/2020 17:14		15	115	0	0	4	
Host Details									
Attended	User Name (Original Email)	Join Time	Leave Time	Time in Session	Country/Region Name				
Yes	Director RVIM director.rvim@rve...	6/24/2020 17:14	#####	15	India				
Panelist Details									
Attended	User Name (Original Email)	Join Time	Leave Time	Time in Session	Country/Region Name				
Yes	Prof NNS Reddy nnsreddy.rvim@rve...	6/24/2020 17:16	#####	13	India				
Yes	Mr. Swapnil Soni swapnilsoniisc@gm...	6/24/2020 17:17	#####	11	India				
Yes	Mr. Srujan Darsi darsisrujan@gmail.c...	6/24/2020 17:14	#####	14	India				
Attendee Details									
Attended	User Name (Original First Name)	Last Name	Email	Registration Time	Approval Status	Join Time	Leave Time	Time in Session	Country/Region Name
No	Preema	Preema	Dsa preemadessa@e...	#####	approved	--	--	--	--
No	Anupama	Anupama	Chaudhari chaudharianupa...	#####	approved	--	--	--	--
No	Priyanka V	Priyanka V	Murthy priyankamurthy...	#####	approved	--	--	--	--
No	Rakesh	Rakesh	N v.rakesh71094@...	#####	approved	--	--	--	--
No	Dr.Praharaju	Dr.Praharaju	Venkata Radhika radhi3sree@yah...	#####	approved	--	--	--	--
No	Manju	Manju	N manjunathn.rvin...	#####	approved	--	--	--	--
No	Chandhan	Chandhan	S chandhangowda...	#####	approved	--	--	--	--
No	Abhay	Abhay	Pai abhaypai2919@...	#####	approved	--	--	--	--
No	Moheet	Moheet	Maurya moheetmaurya.i...	#####	approved	--	--	--	--
No	Tahsin	Tahsin	Hadalge tahsinhadalge98...	#####	approved	--	--	--	--
No	CHETHAN KUMAR	CHETHAN KUMAR	B chethankumarb...	#####	approved	--	--	--	--
No	Nidhi	Nidhi	Natrajan nidhi.natarajan@...	#####	approved	--	--	--	--
No	Narahari	Narahari	K k Rahari2111@gm...	#####	approved	--	--	--	--
No	Ramachandra	Ramachandra	A Naik ranaikathani@g...	#####	approved	--	--	--	--
No	Suraj	Suraj	Muthu mas.suraj@gmai...	#####	approved	--	--	--	--
No	Ankita	Ankita	Bahl ankitadodabahl@...	#####	approved	--	--	--	--
No	ADARSH	ADARSH	B adarsharuna4@i...	#####	approved	--	--	--	--
No	Lakshmi	Lakshmi	Kashyap lakshmi.kashyap...	#####	approved	--	--	--	--
No	Debasish	Debasish	Ghosh debasishghosh.r...	#####	approved	--	--	--	--
No	Shravya	Shravya	Shetty shettyshravya19...	#####	approved	--	--	--	--
No	Vishwanath	Vishwanath	vgangappanavar...	#####	approved	--	--	--	--
No	Dr.Lubna	Dr.Lubna	Ambreen lubnaambreen2...	#####	approved	--	--	--	--
No	Mishra	Mishra	S Mishra Mishra...	#####	approved	--	--	--	--
No	Dr. Jyoti	Dr. Jyoti	S Dr. Jyoti S Dr. Jyoti...	#####	approved	--	--	--	--
No	Arun	Arun	Vijay arunvijaypillai@...	#####	approved	--	--	--	--

Attendee Report

Report Generated: 9/23/2020 11:24

Topic	Webinar ID	Actual Start Time	Actual Duration (minutes)	# Registered	# Cancelled	Unique Viewers	Total Users	Max Concurrent Views		
5 Days FDP on Application of Analytics in the Areas of Management	973 3430 1732	6/23/2020 10:46	157	114	0	104	247	103		
Host Details										
Attended	User Name (Original)	Email	Join Time	Leave Time	Time in Session	Country/Region Name				
Yes	Director RVIM	director.rvim@rvei.edu	6/23/2020 10:46	#####	157	India				
Panelist Details										
Attended	User Name (Original)	Email	Join Time	Leave Time	Time in Session	Country/Region Name				
Yes	Prof NNS Reddy	nnsreddy.rvim@rvei.edu	6/23/2020 10:52	#####	151	India				
Yes	Prof Dileep	dileep.rvim@rvei.edu	6/23/2020 10:47	#####	155	India				
Yes	Dr. Santhosh M	santhoshm.rvim@rvei.edu	6/23/2020 10:48	#####	155	India				
Yes	Dr. Devesh Bathla	devesh.bathla@chitkara.edu	6/23/2020 10:49	#####	151	India				
Attendee Details										
Attended	User Name (Original)	First Name	Last Name	Email	Registration Title	Approval Status	Join Time	Leave Time	Time in Session	Country/Region Name
Yes	Preema Dsa	Preema	Dsa	preemadessa@gmail.com	#####	approved	#####	#####	150	India
Yes	Anupama Chaudhar	Anupama	Chaudhari	chaudharianupama@gmail.com	#####	approved	#####	#####	64	India
Yes	Priyanka V Murthy	Priyanka V	Murthy	priyankamurthyv@gmail.com	#####	approved	#####	#####	4	India
Yes	Priyanka V Murthy	Priyanka V	Murthy	priyankamurthyv29@gmail.com	#####		#####	#####	27	India
Yes	Priyanka V Murthy	Priyanka V	Murthy	priyankamurthyv29@gmail.com	#####		#####	#####	116	India
Yes	Priyanka V Murthy	Priyanka V	Murthy	priyankamurthyv29@gmail.com	#####		#####	#####	86	India
Yes	Priyanka V Murthy	Priyanka V	Murthy	priyankamurthyv29@gmail.com	#####		#####	#####	150	India
Yes	Rakesh N	Rakesh	N	v.rakesh71094@gmail.com	#####	approved	#####	#####	14	India
Yes	Rakesh N	Rakesh	N	v.rakesh71094@gmail.com	#####		#####	#####	72	India
Yes	Rakesh N	Rakesh	N	v.rakesh71094@gmail.com	#####		#####	#####	51	India
Yes	Dr.Praharaju Venka	Dr.Praharaju	Venkata Radhika	radhi3sree@yahoo.com	#####	approved	#####	#####	126	India
Yes	Manju N	Manju	N	manjunathn.rvim@rvei.edu.in	#####	approved	#####	#####	3	India
Yes	Manju N	Manju	N	manjunathn.rvim@rvei.edu.in	#####		#####	#####	8	India
Yes	Chandhan S	Chandhan	S	chandhangowda@gmail.com	#####	approved	#####	#####	149	India
Yes	Abhay Pai	Abhay	Pai	abhaypai2919@gmail.com	#####	approved	#####	#####	87	India
Yes	Moheet Maurya	Moheet	Maurya	moheetmaurya@gmail.com	#####	approved	#####	#####	150	India
Yes	Tahsin Hadalge	Tahsin	Hadalge	tahsinhadalge98@gmail.com	#####	approved	#####	#####	58	India
Yes	CHETHAN KUMAR B	CHETHAN KUMAR	B	chethankumarb@gmail.com	#####	approved	#####	#####	143	India
Yes	Nidhi Natrajan	Nidhi	Natrajan	nidhi.natarajan@gmail.com	#####	approved	#####	#####	149	India
Yes	Ankita Bahl	Ankita	Bahl	ankitadodabahl@gmail.com	#####	approved	#####	#####	1	India
Yes	Ankita Bahl	Ankita	Bahl	ankitadodabahl@gmail.com	#####	approved	#####	#####	150	India
Yes	Ankita Bahl	Ankita	Bahl	ankitadodabahl@gmail.com	#####	approved	#####	#####	2	India

Attendee Report

Report Generated: 9/23/2020 11:29

Topic	Webinar ID	Actual Start Time	Actual Duration (minutes)	# Registered	# Cancelled	Unique Viewers	Total Users	Max Concurrent Views	
5 Days FDP on Application of Analytics in the Areas of Management	973 3430 1732	6/26/2020 10:31		190	118	0	93	235	88

Host Details

Attended	User Name (Origin Email)	Join Time	Leave Time	Time in Sessic Country/Region Name
Yes	Director RVIM director.rvim@rvei.€	6/26/2020 10:31	6/26/2020 13:40	190 India

Panelist Details

Attended	User Name (Origin Email)	Join Time	Leave Time	Time in Sessic Country/Region Name
Yes	Prof NNS Reddy nnsreddy.rvim@rvei	6/26/2020 11:52	6/26/2020 13:40	109 India
Yes	Prof NNS Reddy nnsreddy.rvim@rvei	6/26/2020 10:32	6/26/2020 11:52	80 India
Yes	Padmalini Singh padmalinisinh.rvim	6/26/2020 12:23	6/26/2020 13:39	76 India
Yes	Mr. Jishnu Mukher pokejishnu@gmail.c	6/26/2020 13:03	6/26/2020 13:40	38 India
Yes	Mr. Jishnu Mukher pokejishnu@gmail.c	6/26/2020 10:34	6/26/2020 13:03	150 India
Yes	Mr. Swapnil Soni swapnilsoniisc@gm	6/26/2020 10:41	6/26/2020 13:40	180 India
Yes	Mr. Srujan Darsi darsisrujan@gmail.c	6/26/2020 10:50	6/26/2020 13:12	142 India
Yes	Mr. Srujan Darsi darsisrujan@gmail.c	6/26/2020 13:36	6/26/2020 13:40	4 India
Yes	Prof Dileep dileep.rvim@rvei.ed	6/26/2020 10:32	6/26/2020 13:40	189 India
Yes	Dr. Devesh Bathla priyajain.rvim@rvei.	6/26/2020 12:37	6/26/2020 13:10	34 India
Yes	Dr. Santhosh M santhoshm.rvim@rv	6/26/2020 10:37	6/26/2020 11:52	75 India
Yes	Dr. Santhosh M santhoshm.rvim@rv	6/26/2020 11:52	6/26/2020 13:40	109 India
Yes	Dr. Purushottam B drbung.rvim@rvei.ei	6/26/2020 11:19	6/26/2020 13:40	142 India

Attendee Details

Attended	User Name (Origin First Name)	Last Name	Email	Registration T Approval Status	Join Time	Leave Time	Time in Ses
Yes	Preema Dsa	Preema Dsa	preemadessa@gm	##### approved	#####	6/26/2020 10:59	5
Yes	Preema Dsa	Preema Dsa	preemadessa@gmail.com	#####	#####	6/26/2020 13:40	161
Yes	Preema Dsa	Preema Dsa	preemadessa@gmail.com	#####	#####	6/26/2020 10:55	8
Yes	Anupama Chaudh	Anupama Chaudhari	chaudharianupam:#####	##### approved	#####	6/26/2020 13:38	48
Yes	Anupama Chaudh	Anupama Chaudhari	chaudharianupama@gmail.com	#####	#####	6/26/2020 13:40	161
No	Priyanka V	Priyanka V	Murthy	priyankamurthyv2!##### approved	--	--	--
Yes	Rakesh N	Rakesh N	v.rakesh71094@gr	##### approved	#####	6/26/2020 13:40	161
Yes	Dr.Praharaju Venk.	Dr.Praharaju Venkata Radhika	radhi3sree@yahoo	##### approved	#####	6/26/2020 12:42	64
Yes	Dr.Praharaju Venk.	Dr.Praharaju Venkata Radhika	radhi3sree@yahoo.co.in	#####	#####	6/26/2020 13:40	42
Yes	Manju N	Manju N	manjunathn.rvim@#####	##### approved	#####	6/26/2020 11:57	3
Yes	Manju N	Manju N	manjunathn.rvim@rvei.edu.in	#####	#####	6/26/2020 11:07	6
Yes	Manju N	Manju N	manjunathn.rvim@rvei.edu.in	#####	#####	6/26/2020 11:59	1
No	Chandhan	Chandhan S	chandhangowda.s(#####	##### approved	--	--	--
Yes	Abhay Pai	Abhay Pai	abhaypai2919@gn	##### approved	#####	6/26/2020 12:58	93
Yes	Padmalini Singh	Padmalini Singh	padmalinisinh.rvi	##### approved	#####	6/26/2020 12:09	5
Yes	CHETHAN KUMAR	CHETHAN KUMAR B	chethankumarb.rv	##### approved	#####	6/26/2020 13:40	166



FDP on 'Building Research Capabilities in Management & Social Science'
 By
Teaching learning Centre

Date: 19 th -25 th July, 2020	Venue: Webinar / Zoom meeting
Time: 09.30am to 01.30pm	Event : Faculty Development Program
No. of Participant: 100	Event Convener: Dr. Purushottam Bung Dr. Padmalini Singh Event Coordinator: Prof. Priya Jain

Objectives

- The FDP is intended to support researchers in their quest for enhancing their research capabilities and skills to carry out quality research in management and social science discipline.

Agenda/Flow of the Event

Date Day	Session I Expert Talk		Session II Practice session Experts: Dr. Purushottam Bung Dr. Padmalini Singh
Time →	09:00 am -10:30 am (Morning) FOLLOWED BY 20-25 MINUTES Q&A		11:30 am-01:30 pm (Afternoon)
19 th July Sunday	Dr. Sourav Borah Assistant Professor, Marketing IIM-Ahmadabad	Framing the Manuscript	Problem Identification
20 th July Monday	Dr. Souvik Dutta Assistant Professor at IIT, Delhi	Problem Statement Review of literature Identifying research gaps	Introduction Hooking strategy
Time →	02:00 pm -03:30 pm (Afternoon) FOLLOWED BY 20-25 MINUTES Q&A		11:30 am-01:30 pm (Afternoon)
21 st July Tuesday	Dr. Charan Singh, Chief Executive EGROW Foundation	Research questions Framing objectives Framing Hypothesis	Review of literature Identifying research gaps
Time →	09:00 am -10:30 am (Morning) FOLLOWED BY 20-25 MINUTES Q&A		11:30 am-01:30 pm (Afternoon)
22 nd July Wednesday	Dr. M.H.Bala Subrahmanya Professor,	Research Process and Research Design	Research questions

LUNCH



	Management Studies, IISc, Bangalore		
23 rd July Thursday	Dr. Pawan Kumar Singh Director, MDI Gurgaon	Interpreting findings and writing insightful conclusion	Framing Objectives Framing Hypothesis
Time →	09:00 am -10:00 am (Morning) INCLUDING 20-25 MINUTES Q&A		11:30 am-01:30 pm (Afternoon)
24 th July Friday	Dr. Pranav Garg Assistant Professor, Stevens Institute of Technology, Hoboken, New Jersey	Formulating a publication strategy	Research Design
Time →	11:30 am -12:30 pm (Morning) FOLLOWED BY 20-25 MINUTES Q&A		01:00 pm-02:30 pm (Afternoon)
25 th July Saturday	Dr. Azhar Kazmi Professor, King Fahd University of Petroleum & Minerals, Saudi Arabia	Publication Ethics	Entire research plan & way forward & Feedback

Outcome Achieved/ Attained:

One week FDP was completely appreciated by the participants. The expert's talk followed with the workshop was very helpful in practicing the concepts learnt by the participants.

Few testimonials of the participants:

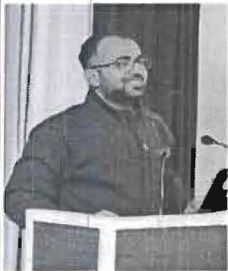

Prof. Javed Shaikh,
Academic Associate,
IIM-Ahmadabad

"Hands on exercises which forced me to apply my understanding in practical manner".

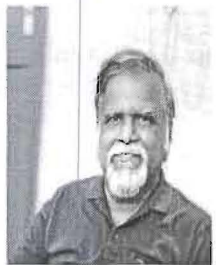

Mr. Mohanadoss Balaguru
Principal Consultant
HR Net Consultants Private Ltd

"Academic Excellence combined with Practical Experience of the Speakers coupled with support from Dr. Purushottam Burg, Dr. Padmalini Singh and Dr. Priya Singh, 'Walked The Talk' from Introduction to Publication made participants understand the entire Chain of Research / Thesis / Proposal and Paper."



Mr. I. IMTIAZ BAIG
Talent Manager
Baig & Associates

"The structure and design, Choice of Resource persons/ speakers from all over. Blend of both knowledge and skills, Skills through Practice Sessions. Magnanimity of the Institute to support and share resources."



Dr. MEERA B
HOD Department of Business Administration
SJR college

"Well organized and commendable leader and excellent speakers"



Dr. BASAVARAJU P S
Assistant Professor,
GMIT, Davangere

"Wonderful programme with time management, coordination communication"

Academic Papers: Crafting A Manuscript

- Six Major Components
- Introduction and Motivation
 - The problem should have broad practical and academic relevance.
 - Should be generalizable.
- Literature Review
 - It is not copy paste job.
 - Relevant vs. Irrelevant literature.
- Hypothesis Development
 - Intuitive vs. Non-intuitive hypothesis
 - Literature is not hypothesis.
- Methodology

WHERE DOES A PROBLEM STATEMENT ORIGINATE FROM?

- A good problem originates from a research question formulated out of observation of the reality.
- A literature review and a study of previous experiments, and research, are good sources of research questions that are converted to statements of problem.
- Many scientific researchers look at an area where a previous researcher generated some interesting results, but never followed up. It could be an interesting area of research, which nobody else has fully explored.

RESEARCH PROCESS

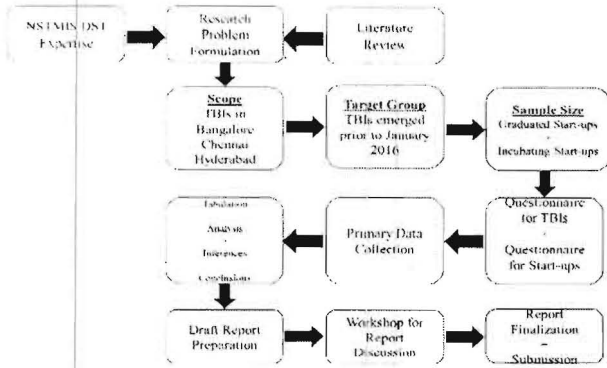

Snapshot of few days

Anchor on theory or phenomenon?

- Most scholars develop identity along one axis
 - Rows are theoretical perspectives
 - Columns are phenomena
- Typically, management papers are at the interface
 - A theoretical perspective and a phenomenon

	M&A	Alliances	Business groups
Resource Based View			
Transaction cost economics			
Agency theory			

Feedback & Coordinator Comment:

The FDP program was received much appreciation by all the participants. The participants also valued and enjoyed the interaction with the experts as well as during the workshop. The participants have requested to organize FDPs and workshop on research in future too.

Event Convener: Dr. Padmalini Singh

Director

Event Coordinator: Prof. Priya Jain

Annexure 1	Proposal / Approval
Annexure 2	Circular / Brochure of the event
Annexure 3	Brief profile of the speaker
Annexure 4	Attendees list
Annexure 5	Photo Gallery
Annexure 6	Detail Feedback (if required)
Annexure 7	Any other related documents



FDP on EMERGING TECHNOLOGIES- WAY FORWARD (In association with RV SKILLS)	
Date: 3 rd Aug to 8 th Aug 2020	Venue: Zoom webinar
Time: 11 am to 1 pm	Event : Webinar
No. of Participant: 171	Event Coordinator: Dr. Santhosh M Prof. Reddy Prof Dileep Prof. Priya Jain Ms. Vidya (RV SKILSS)
Objectives <ul style="list-style-type: none">- To gain deeper understanding of the concept of Artificial Intelligence- To identify the future of block chain in India and world.- To understand the concept of IOT and its opportunities and challenges and solutions.- To analyze the importance of Robotics Process Automation in today's world- To examine the future of Cryptocurrency.- To have knowledge about the cloud computing	
Agenda/Flow of the Event <ul style="list-style-type: none">• 3rd Aug- Artificial intelligence by Mr. Chinmaya Mishra, Lead Data Scientist, Microsoft• 4th Aug- Future of Block Chain by Mr. Stanly Johnson, Block Chain developer and researcher• 5th Aug- IOT- opportunities, challenges and solutions by Mr Raghu Venkataramana, Director- Qantom Software Pvt. Ltd.• 6th Aug- Cryptocurrency by Mr. Stanly Johnson, Block Chain developer and researcher• 7th Aug- Robotic Process Automation by Mr. Gulshan kumar, programmer Analyst, Inventys Technology pvt. Ltd.• 8th Aug- Travel in the cloud by Mr. Mahesh P, Infrastructure Engineer Architect, Data management startup.	
Outcome Achieved/ Attained: <ul style="list-style-type: none">- Mr. Chinmaya Mishra started the program on the first day and explained a clear distinction	

between Artificial intelligence, machine Learning and Deep learning. He used CRISP Data Mining Model to solve business problems. He described the use of analytics for recommendations.

- On the second day Mr. Stanly Johnson started the session with the article on Bitcoin: A Peer to Peer Cash System. He explained in detail how block chain functions and what will be the future of block chain.
- Third day session was taken by Mr. Raghu on the topic IOT. He briefly explained what is IOT, its history, opportunities, challenges and solutions. He also told about various application domains of IOT. He showed some videos on the application of IOT for better understanding of participants.
- Fourth day session was taken over by Mr Stanly again on the topic Cryptocurrency. He explained briefly how cryptocurrency works and what is the future of it. He also explained various types of cryptocurrency and motivated audience to invest in same. What are the security points during investment were also very clearly explained by him.
- Fifth day the session was taken over by Mr. Gulshan Kumar on Robotics Process Automation. He explained what is RPA, how it works and various tools of RPA like Blue Prism, Automation Anywhere, UiPath etc. he also explained what should be the selection criterion for the tool.
- Last day session was taken by Mr. Mahesh on Cloud computing. He started the session with quote Travel in the cloud like you travel on the road; travel in the cloud is not just reaching the target but is an experience that you would be excited. He explained about storage of data on the cloud, how it works and various myths associated with it

Feedback & Coordinator Comment:

The entire program was very well received by all the participants. All the participants appreciated the program and were happy to have deeper knowledge on emerging trends. During the sessions participants had a chance to know how various new technologies works and how they can be used in our daily life to solve various problems.

Event Coordinator(s)

M. N. Reddy (Prof. Nagasubba Reddy)
K. P. Sankar (Dr. Santosh M)
Dileep (Prof. Dileep)
Praveen (Prof. Praveen)

~~Director~~

Annexure 1	Proposal / Approval	Attached
Annexure 2	Circular / Brochure of the event	Attached
Annexure 3	Brief profile of the speaker	Attached
Annexure 4	Attendees list	Attached
Annexure 5	Photo Gallery	Attached
Annexure 6	Detail Feedback (if required)	attached
Annexure 7	Certificate copy	attached

Annexure 2
Circular / Brochure of the event
Brochure

 **RV Institute of Management**
Approved by Bangalore Central University
Approved by AICTE, New Delhi. Accredited by NAAC with 'A+' grade

Go, change the world



RV Institute of Management
In association with
RV-SKILLS
CENTRE FOR KNOWLEDGE TECHNOLOGY
Is Organizing an FDP On

“Emerging Technologies- A WAY FORWARD”
From 3rd August to 8th August, 2020
11.00 am to 1.00 pm

SPEAKERS

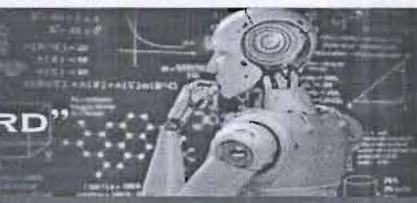

Chinmaya Mishra
Lead Data Scientist Microsoft
(Topic- Artificial Intelligence)



Gulshan Kumar
Programmer Analyst
Inventys Technology Pvt. Ltd
(Topic - Robotic Process Automation)



Stanly Johnson
Block Chain Developer and Researcher
(Topic-Future of Block Chain and Crypto Currency)



Raghu Venkataramana
Director, Qantom Software Pvt. Ltd.
(Topic-IOT- Opportunities, Challenges and Solutions)



Mr. Mahesh P
Infrastructure Engineer Architect
A Data Management Startup
(Topic- Travel in the Cloud)

Moderator



Mr. Venkatesh Prasad
Professor and Director,
RV SKILLS, Bangalore



Dr. Purushottam Bung
Professor and Director
RV Institute of Management, Bangalore

Participation Fee: Rs. 500/- Faculty / Scholars Rs. 200/- Students

Once you make the payment please register through the google form link
<https://forms.gle/E78e5Bh45vqfMriv9>

E-certificates will be provided to all the registered participants

Payment Details:

Name: Director RV Institute of Management
Bank Name: ICICI Bank, 9th Block Branch,
A/C No.: 029901002291
IFSC Code: ICIC0000299
MICR Code: 560229022
UPI ID : directorrvim@icici



For further clarification please contact:

Dr. Santhosh @ 9739945333
Prof. Reddy @ 9845492336
Prof. Dileep @ 8553276869
Prof. Priya @ 9108300728
Ms. Vidya @ 7349389666

✉ businessanalyst.fdp2020@gmail.com

Annexure 3
Brief profile of the speaker

Brief Profile of the Resources Persons

1. Mr Raghu Venkataramana, Director- Qantom Software Pvt. Ltd.



- Mr. Raghu is the founder and CEO of Qantom Software Private Limited.
- He has done is post graduate in IOT from Birla Institute of Technology and Science, Pilani.
- After working on various technologies like VOIP, Networking, IP Phone etc now he is completely focused on building products and frameworks for IOT Experience.
- Till now he has created many IOT products like prototype of an IOT framework which allows for easy discovery and configuration of IOT end points; a framework to manage unit and automated tests directly from spreadsheets; created a utility which helped Quick test users to manage the descriptive repositories and many more.
- Mr. Raghu is very strong in core java and object oriented development. He is expert in SQA and test automation.
- In his initial years of professional career he has worked in the fields of graphic design and turnkey printing and has build his entrepreneurial skills.

2. Mr. Chinmaya Mishra, Lead Data Scientist, Microsoft



- Mr. Chinmaya is the enthusiastic learner in Artificial Intelligence field with Machine Learning and

Deep learning skills.

- Currently he is leading data science team consists of threat intelligence, hunting, Insider risk and compliance.
- He is a sensible team leader with leading midsize teams and have good record of working closely with cross functional teams across security, operations, marketing and supply chain.
- His passion is mentoring various data science aspirants.
- He loves to explore more in cyber security and Engineering analytics which brought him to work for Fortune 500 companies like Honeywell, Rockwell Collins, Collins Aerospace and Microsoft.
- He has worked on many critical projects like connected ecosystem, cyber security and many more.
- He got an exposure of business aspects of Artificial Intelligence while doing analytics in Retail Finance at Bajaj Auto Finance.
- He is also specialized in Big data technology like Hadoop, R, Python, PYSpark SAS and SPSS

3. Mr. Stanly Johnson, Block Chain developer and researcher



- Mr. Stanly Johnson is a software engineer passionate about developing solutions that make a dent in the universe.
- He has worked on medical block chain platforms; IOT based supply chain solutions, cry exchanges and is an early contributor to the Corda Enterprise block chain platform.
- He is a certified block chain architect and was one of the first employees of Serventire Global. India's first block chain acquisition.
- He currently works as a block chain developer for a leading crypto currency exchange in South korea

4. Mr. Gulshan kumar, programmer Analyst, Inventys Technology pvt. Ltd.

(Full CV attached)

5. Mr. Mahesh P, Infrastructure Engineer Architect, Data management startup.

(Full CV attached)

Annexure 5 Photo Gallery

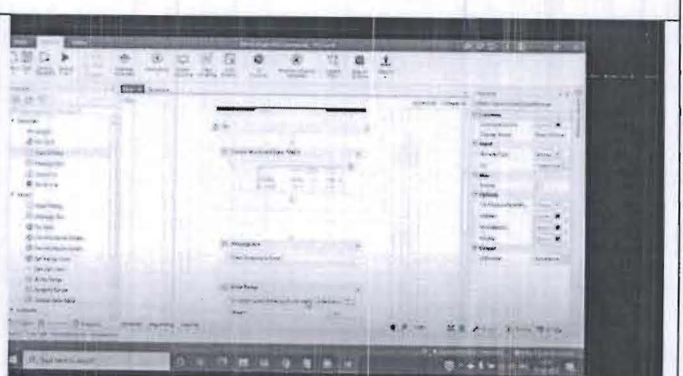
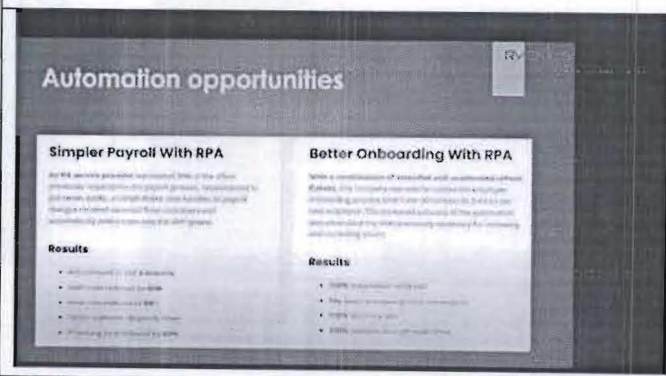
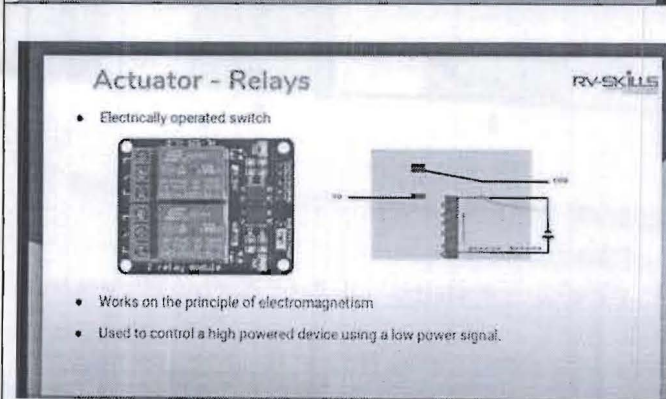
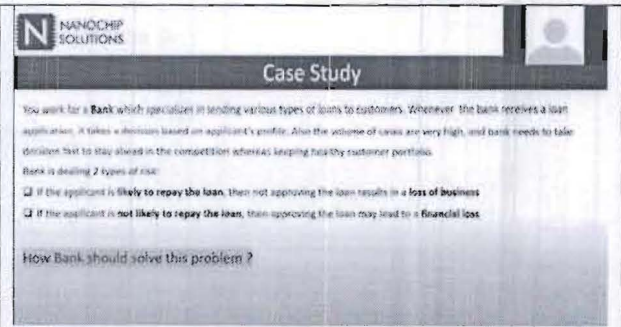
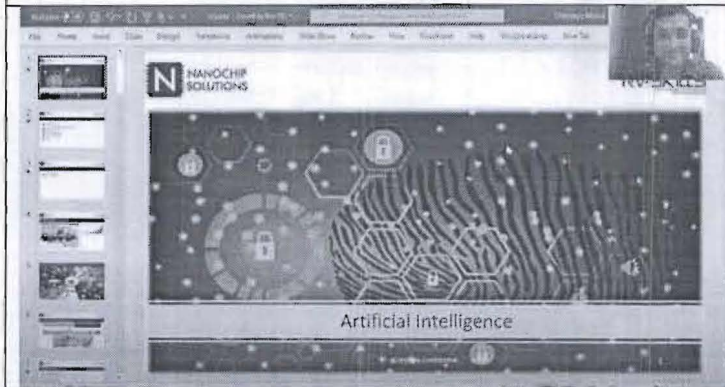

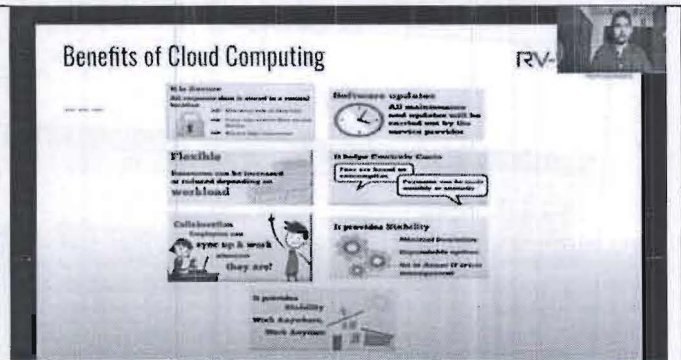
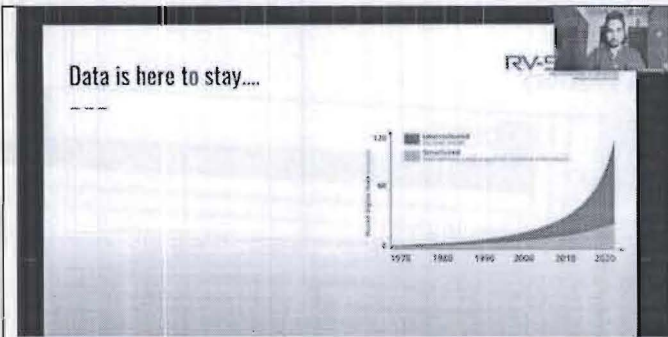

Annexure 6

Detail Feedback

Overall rating of the resource person considering command on the subject matter and delivery : Mr.Chinmaya Mishra,Topic- Artificial Intelligence

82 responses

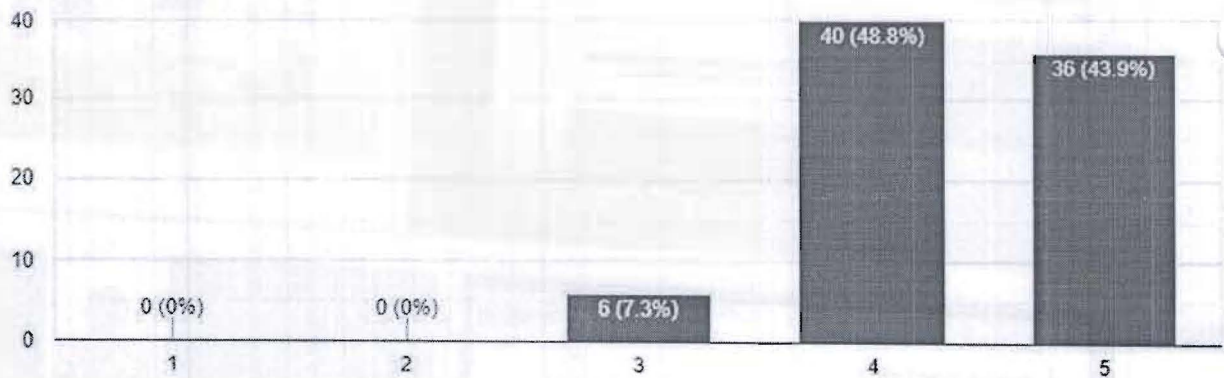

Overall rating of the resource person considering command on the subject matter and delivery : Mr.Stanly Johnson,Topic - Future of Block chain

82 responses

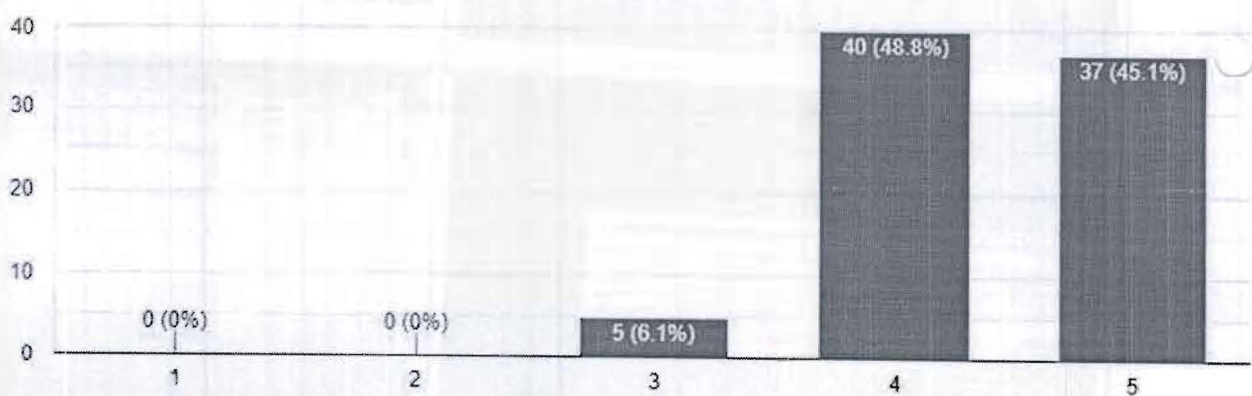

Overall rating of the resource person considering command on the subject matter and delivery : Mr.Stanly Johnson,Topic - Cryptocurrency

82 responses

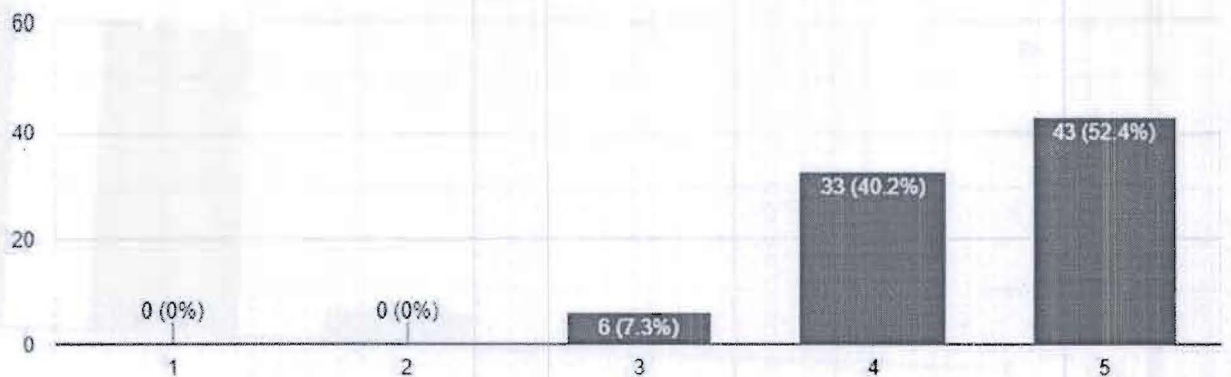

Overall rating of the resource person considering command on the subject matter and delivery : Mr.Raghu Venkataramana,Topic-IOT- Opportunities,Challenges and Solutions)

82 responses

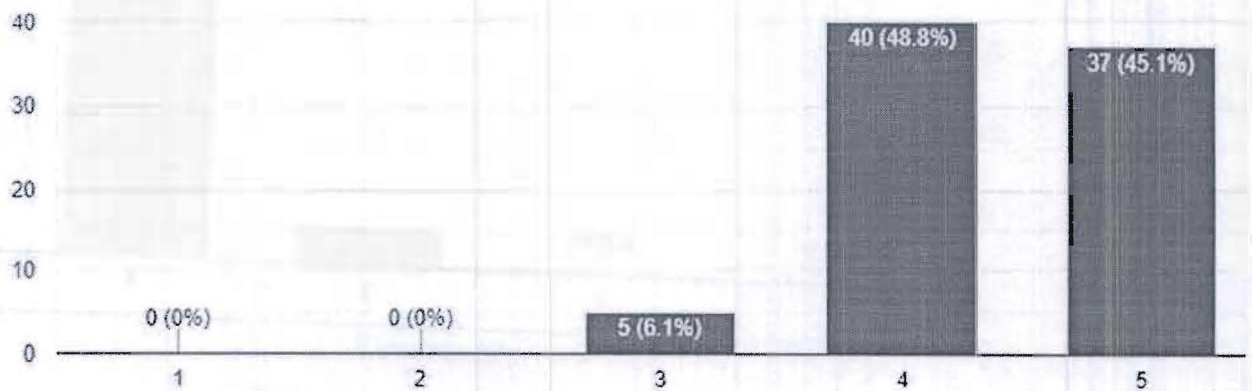

Overall rating of the resource person considering command on the subject matter and delivery : Mr.Gulshan Kumar,Topic - Robotic Process Automation.

82 responses

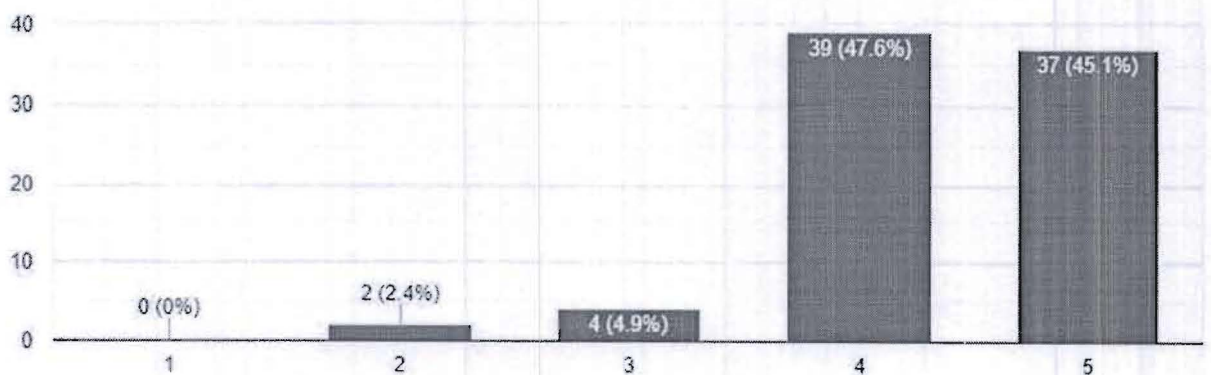

Overall rating of the resource person considering command on the subject matter and delivery : Mr. Mahesh P,Topic- Travel in the Cloud

82 responses

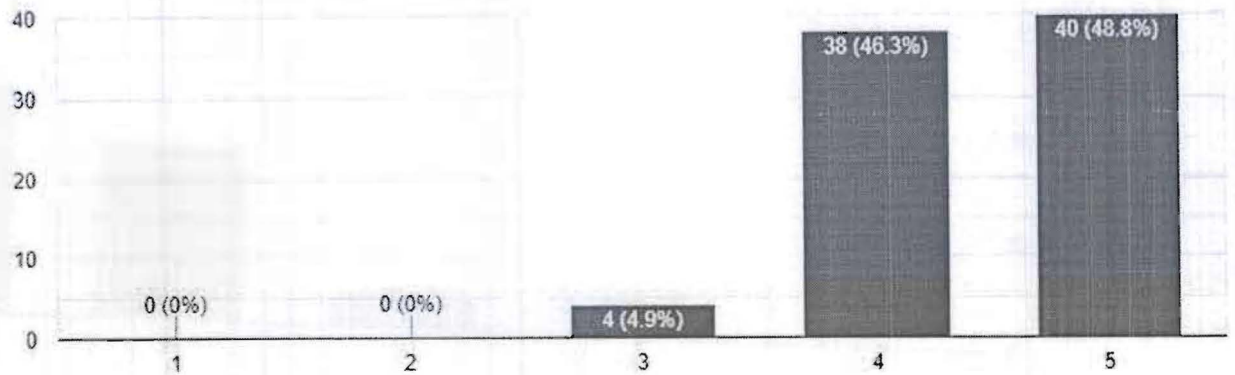

Overall rating on conduct of FDP

82 responses

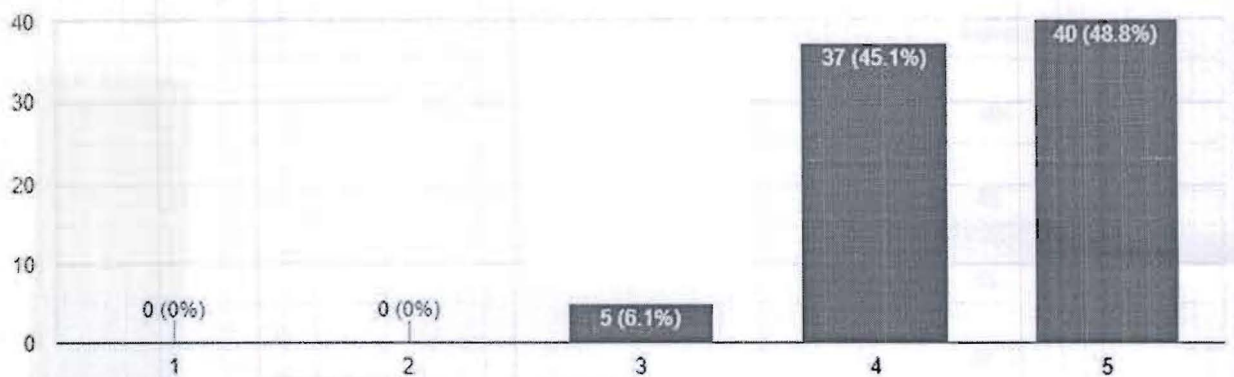

Annexure 7

Certificate Copy Attached

Attendee
Report

Generated: 9/23/2020 16:02

Topic Webinar ID Actual Start Time Actual Duration (minutes) # Registered # Cancelled Unique Viewers Total Users Max Concurrent Views

Emerging
Technologies- A

WAY FORWARD 991 6467 8232 8/3/2020 10:31 173 197 0 171 548 155

Host Details

Attended	User Name (Original Name)	Email	Join Time	Leave Time	Time in Session (minutes)	Country/Region Name
Yes	Priya Jain (Director RVIM)	director.rvim@rvei.edu	8/3/2020 10:31	8/3/2020 13:24	173	India

Panelist Details

Attended	User Name (Original Name)	Email	Join Time	Leave Time	Time in Session (minutes)	Country/Region Name
Yes	Dr. Purushottam Bung	drbung.rvim@rvei.edu	8/3/2020 10:34	8/3/2020 13:24	170	India
Yes	Dr Santhosh	santhoshm.rvim@rvei.	8/3/2020 10:33	8/3/2020 13:24	171	India
Yes	Prof. Reddy	nnsreddy.rvim@rvei.e	8/3/2020 10:43	8/3/2020 13:24	162	India
Yes	Mr. Dileep	dileep.rvim@rvei.edu.i	8/3/2020 10:36	8/3/2020 10:43	8	India
Yes	Mr. Dileep	dileep.rvim@rvei.edu.i	8/3/2020 11:00	8/3/2020 13:24	145	India
Yes	Ms Vidya	vidya@rv-skills.com	8/3/2020 10:35	8/3/2020 13:24	170	India
Yes	Mr. Venkatesh Prasad	vprasad@rv-vlsi.com	8/3/2020 10:43	8/3/2020 12:17	94	India
Yes	Mr. Chinmaya Mishra	chinmaya086@yahoo.	8/3/2020 10:43	8/3/2020 13:24	162	India

Attendee
Details

Attended	User Name (Original Name)	First Name	Last Name	Email	City	Phone	Organization	Registration Time	Approval St
Yes	BALAJI RAJ V T	BALAJI	RAJ V T	balajiyash004@g	BENGALURU	9980582536	R.V Institute C	8/2/2020 18:45	approved
Yes	Bhumika S j	Bhumika	S j	bhumika.shuntika	Bangalore	7337687727	RV institute o	8/3/2020 10:29	approved
Yes	Bhumika S j	Bhumika	S j	bhumika.shuntikatte@gmail.com					
Yes	Bhumika S j	Bhumika	S j	bhumika.shuntikatte@gmail.com					
Yes	Bhumika S j	Bhumika	S j	bhumika.shuntikatte@gmail.com					
Yes	Namrata Kotur	Namrata	Kotur	namratakotur@g	Haveri	9035787315	R.V.INSTITUT	8/2/2020 12:42	approved
No	Ayesha	Ayesha	Banu N	ayashaaye01@g	Bangalore	8660186262	NMKRV colleg	8/3/2020 11:13	approved
Yes	Hanisha Tadavarthy	Hanisha	Tadavarthy	hanishatadavarth	Banglore	8867119968	R V INSTITUT	8/2/2020 11:56	approved

Attendee Report

Report Generated: 9/23/2020 16:05

Topic	Webinar ID	Actual Start Time	Actual Duration (minutes)	# Registered	# Cancelled	Unique Viewers	Total Users	Max Concurrent Views
Emerging Technologies- A WAY FORWARD	991 6467 8232	8/4/2020 10:29	126	207	0	167	465	160

Host Details

Attended	User Name (Original Name)	Email	Join Time	Leave Time	Time in Session (minutes)	Country/Region Name
Yes	Priya Jain (Director RVIM)	director.rvim@rvei.edu.in	8/4/2020 10:29	8/4/2020 12:35	126	India

Panelist Details

Attended	User Name (Original Name)	Email	Join Time	Leave Time	Time in Session (minutes)	Country/Region Name
Yes	Mr. Stanly Johnson	stanlyjohnson@outlook.com	8/4/2020 10:44	8/4/2020 12:35	111	India
Yes	Dr. Purushottam Bung	drbung.rvim@rvei.edu.in	8/4/2020 10:51	8/4/2020 12:35	104	India
Yes	Dr Santhosh	santhoshm.rvim@rvei.edu.in	8/4/2020 10:48	8/4/2020 12:35	107	India
Yes	Prof. Reddy	nnsreddy.rvim@rvei.edu.in	8/4/2020 10:37	8/4/2020 11:01	24	India
Yes	Prof. Reddy	nnsreddy.rvim@rvei.edu.in	8/4/2020 11:06	8/4/2020 11:08	3	India
Yes	Prof. Reddy	nnsreddy.rvim@rvei.edu.in	8/4/2020 11:08	8/4/2020 12:35	87	India
Yes	Mr. Dileep	dileep.rvim@rvei.edu.in	8/4/2020 10:30	8/4/2020 12:35	125	India
Yes	Ms Vidya	vidya@rv-skills.com	8/4/2020 10:39	8/4/2020 12:35	117	India

Attendee Details

Attended	User Name (Original Name)	First Name	Last Name	Email	City	Phone	Organization	Registration Time	Approval Status	Join Time	Leave Time	Time in Session
Yes	BALAJI RAJ V T	BALAJI RAJ	V T	balajiyash004@gmail.com	BENGALURU	9.98E+09	Institute Of Management	#####	approved	#####	#####	118

Attendee Report

Report

Generated: 9/23/2020 16:06

Topic	Webinar ID	Actual Start Time	Actual Duration (minutes)	# Registered	# Cancelled	Unique Viewers	Total Users	Max Concurrent Views
Emerging Technologies- A WAY FORWARD	991 6467 8232	8/5/2020 10:37	162	210	0	147	435	144

Panelist Details

Attended	User Name (Original Name)	Email	Join Time	Leave Time	Time in Session (minutes)	Country/Region Name
Yes	Dr. Purushottam Bung	drbung.rvim@rvei.edu.in	8/5/2020 11:01	8/5/2020 13:18	138	India
Yes	Dr Santhosh	santhoshm.rvim@rvei.edu.in	8/5/2020 10:41	8/5/2020 13:18	158	India
Yes	Prof. Reddy	nnsreddy.rvim@rvei.edu.in	8/5/2020 10:37	8/5/2020 13:18	162	India
Yes	Mr. Raghu Venkataramana	raghuphone2@gmail.com	8/5/2020 10:37	8/5/2020 13:18	162	India
Yes	Mr. Dileep	dileep.rvim@rvei.edu.in	8/5/2020 10:47	8/5/2020 13:18	152	India
Yes	Ms Vidya	vidya@rv-skills.com	8/5/2020 12:11	8/5/2020 13:18	68	India
Yes	Ms Vidya	vidya@rv-skills.com	8/5/2020 10:38	8/5/2020 12:09	91	India

Attendee Details

Attended	User Name (Original Name)	First Name	Last Name	Email	City	Phone	Organization R.V Institute Of Managem	Registration Time	Approval Status	Join Time	Leave Time
Yes	BALAJI RAJ V T	BALAJI RAJ	V T	balajiyash004@gmail.com	BENGALURU	9.98E+09	ent	#####	approved	#####	#####
Yes	BALAJI RAJ V T	BALAJI RAJ	V T	balajiyash004@gmail.com						#####	#####

Attendee
Report
Report

Generated: 9/23/2020 16:08

Topic	Webinar ID	Actual Start Time	Actual Duration (minutes)	# Registered	# Cancelled	Unique Viewers	Total Users	Max Concurrent Views
Emerging Technologies- A WAY FORWARD	991 6467 8232	8/6/2020 10:27	158	210	0	137	384	128

Host Details

Attended	User Name (Original Name)	Email	Join Time	Leave Time	Time in Session (minutes)	Country/Region Name
Yes	Priya Jain (Director RVIM)	director.rvim@rvei.edu.in	8/6/2020 10:27	8/6/2020 13:04	158	India

Panelist Details

Attended	User Name (Original Name)	Email	Join Time	Leave Time	Time in Session (minutes)	Country/Region Name
Yes	Mr. Stanly Johnson	stanlyjohnson@oulook.com	8/6/2020 10:39	8/6/2020 13:04	145	India
Yes	Dr. Purushottam Bung	drbung.rvim@rvei.edu.in	8/6/2020 11:15	8/6/2020 13:04	110	India
Yes	Dr Santhosh	santhoshm.rvim@rvei.edu.in	8/6/2020 10:54	8/6/2020 13:04	131	India
Yes	Prof. Reddy	nnsreddy.rvim@rvei.edu.in	8/6/2020 10:35	8/6/2020 13:04	149	India
Yes	Mr. Gulshan Kumar	er.gulshankumar2014@gmail.com	8/6/2020 10:35	8/6/2020 13:04	150	India
Yes	Mr. Dileep	dileep.rvim@rvei.edu.in	8/6/2020 10:44	8/6/2020 13:04	141	India
Yes	Ms Vidya	vidya@rv-skills.com	8/6/2020 11:29	8/6/2020 11:46	17	India
Yes	Ms Vidya	vidya@rv-skills.com	8/6/2020 10:33	8/6/2020 11:28	56	India
Yes	Ms Vidya	vidya@rv-skills.com	8/6/2020 12:05	8/6/2020 13:04	60	India

Attendee
Details

Attendee
Report
Report
Generate
d: 9/23/2020 16:09

Topic	Webinar ID	Actual Start Time	Actual Duration (minutes)	# Registered	# Cancelled	Unique Viewers	Total Users	Max Concurrent Views
Emerging Technologies- A WAY FORWARD	991 6467 8232	8/7/2020 10:30	150	210	0	131	287	123

Host
Details

Attended	User Name (Original Name)	Email	Join Time	Leave Time	Time in Session (minutes)	Country/Region Name
Yes	Priya Jain (Director RVIM)	director.rvim@rvei.edu.in	8/7/2020 10:30	8/7/2020 13:00	150	India

Panelist
Details

Attended	User Name (Original Name)	Email	Join Time	Leave Time	Time in Session (minutes)	Country/Region Name
Yes	Dr. Purushottam Bung	drbung.rvim@rvei.edu.in	8/7/2020 10:55	8/7/2020 13:00	126	India
Yes	Dr Santhosh	santhoshm.rvim@rvei.edu.in	8/7/2020 11:01	8/7/2020 13:00	119	India
Yes	Prof. Reddy	nnsreddy.rvim@rvei.edu.in	8/7/2020 10:45	8/7/2020 13:00	135	India
Yes	Mr. Gulshan Kumar	er.gulshankumar2014@gmail.com	8/7/2020 10:35	8/7/2020 13:00	145	India

Attendee Report

Report Generated: 9/23/2020 16:10

Topic	Webinar ID	Actual Start Time	Actual Duration (minutes)	# Registered	# Cancelled	Unique Viewers	Total Users	Max Concurrent Views
Emerging Technologies- A WAY FORWARD	991 6467 8232	8/8/2020 10:24	173	210	0	121	458	113

Host Details

Attended	User Name (Original Name)	Email	Join Time	Leave Time	Time in Session (minutes)	Country/Region Name
Yes	Priya Jain (Director RVIM)	director.rvim@rvei.edu.in	8/8/2020 10:24	8/8/2020 13:16	173	India

Panelist Details

Attended	User Name (Original Name)	Email	Join Time	Leave Time	Time in Session (minutes)	Country/Region Name
Yes	Mr. Mahesh P	mahi.trainer@gmail.com	8/8/2020 10:31	8/8/2020 10:40	10	India
Yes	Mr. Mahesh P	mahi.trainer@gmail.com	8/8/2020 10:40	8/8/2020 13:10	151	India
Yes	Dr. Purushottam Bung	drbung.rvim@rvei.edu.in	8/8/2020 10:30	8/8/2020 13:16	167	India
Yes	Dr Santhosh	santhoshm.rvim@rvei.edu.in	8/8/2020 11:01	8/8/2020 13:14	133	India
Yes	Prof. Reddy	nnsreddy.rvim@rvei.edu.in	8/8/2020 10:47	8/8/2020 13:14	147	India
Yes	Mr. Dileep	dileep.rvim@rvei.edu.in	8/8/2020 10:38	8/8/2020 13:15	157	India
Yes	Ms Vidya	vidya@rvskills.com	8/8/2020 12:21	8/8/2020 12:23	2	India
Yes	Ms Vidya	vidya@rvskills.com	8/8/2020 10:25	8/8/2020 12:23	119	India
Yes	Ms Vidya	vidya@rvskills.com	8/8/2020 12:24	8/8/2020 13:10	47	India
Yes	Mr. Venkatesh Prasad	vprasad@rvvlsi.com	8/8/2020 10:51	8/8/2020 12:04	74	India
Yes	Mr. Venkatesh Prasad	vprasad@rvvlsi.com	8/8/2020 12:45	8/8/2020 13:10	25	India

Attendee Details

Gulshan Kumar

7th Cross,16th main, BTM,2nd Stage, Bengaluru, KA 560076 | 888 048 2405 | er.gulshankumar2014@gmail.com

Professional Summary

Results-oriented RPA developer having 4.8 years' experience in Automation with the web and window-based Applications. Created RPA structure and team along with production support, designed and developed RPA solutions to accelerate Business processes. Flexible and resourceful professional with deep understanding of acceptance criteria.

Skills

- Working Experience with RPA development with UiPath, Blue Prism, Fusion.
- Well acquainted with RPA life cycle, PDD, TDD and OMD
- Experience in creating automation from scratch using UiPath
- Well versed in PDF and Excel automation with UiPath
- Experience with Selectors and Exception handling
- Experience in Email automation with POP, IMAP and Exchange mail services
- Exposure with .net functions for basic UiPath usage
- Exposure to UiPath orchestrator with queues, scheduler and Assets
- Exposure to Blue Prism studio and control room
- Exposure to VBOs and Exception handling in Blue prism
- Experience in Manual and automation testing using selenium web driver
- Experience in Bug life cycle, SDLC and STLC
- Exposure with java and SQL
- Experience with project management tool like JIRA, Bugzilla
- Experience in JMeter and Blaze-meter
- Exposure to GIT, Maven, SVN
- Having strong problem solving and effective communication skills

Work History

RPA Developer

Inventys technology Pvt. Ltd.

Feb 2018 - Current
Bengaluru, KA

Project 1: - Retail Chain Management (Payments):

- **Client** : TGBL
- **Duration** : 10 months
- **Team Size** : 2
- **Technology** : RPA
- **Tools Used** : UiPath, Excel

Description: Main objective of this project was to create documents like Sales order, Delivery challan, and Sales invoices and to manage stock of the company. Source data was being downloaded from a website in the form of excel.

Roles and Responsibilities:

- Adopted Agile methodology for implementation.
- Prepared automation concept and control drawings according to client's specifications.
- Performed needs and gaps analysis procedures and detailed data reviews to optimize implementation.
- Updated and maintained project documentation for detailed recordkeeping.
- Developed technical solutions to resolve a range of problems.
- Discussed requirements and processes with project managers and Client

- Worked with Business Teams to create **PDD (Process Definition Document)** and developed separate **SDD (Solution Design Documents)**
- Created end to end automation with the help of UiPath tool.
- Used Web, PDF, Email, Excel and File automation to develop this process.
- Used UiPath Orchestrator for deployment, monitoring and management of automation.
- Attended daily status call with client, shared status report.

Project 2: - Insurance Claim Management:

- **Client** : Michelin
- **Duration** : 8 months
- **Team Size** : 2
- **Technology** : RPA
- **Tools Used** : UiPath, Sql

Description: Main objective of this project was to update all the settled claims to one portal to another portal based on the dates provided. All the unsettled claims need to be process based on the rules provided by client.

Roles and Responsibilities:

- Adopted Agile methodology for implementation.
- Performed needs and gaps analysis procedures and detailed data reviews to optimize implementation.
- Updated and maintained project documentation for detailed recordkeeping.
- Developed technical solutions to resolve a range of problems.
- Discussed requirements and processes with project managers and Clients.
- Created end to end automation with the help of UiPath tool.
- Used Web, Database, Email, Data-table and File automation to develop this process.
- Used UiPath Orchestrator for deployment, monitoring and management of automation.
- Attended daily status call with client, shared status report.

Project 3: - Supply Chain Management:

- **Client** : Amco
- **Duration** : 8 months
- **Team Size** : 3
- **Technology** : RPA
- **Tools Used** : UiPath, CSV

Description: Main objective of this project was to create invoice based on the data provided in a different portal which will be downloaded into .csv format. We need to read the invoice details and upload it to another portal with unique invoice number.

Roles and Responsibilities:

- Adopted Agile methodology for implementation.
- Performed needs and gaps analysis procedures and detailed data reviews to optimize implementation.
- Updated and maintained project documentation for detailed recordkeeping.
- Developed technical solutions to resolve a range of problems.
- Discussed requirements and processes with project managers and Clients.
- Created end to end automation with the help of UiPath tool.
- Used Web, CSV, Email and File automation to develop this process.
- Used UiPath Orchestrator for deployment, monitoring and management of automation.
- Attended daily status call with client, shared status report.

Project 4: - Ewaybill Creation:

- **Client** : Fleet-Guard

- **Duration** : 4 months
- **Team Size** : 3
- **Technology** : RPA
- **Tools Used** : UiPath

Description: Main objective of this project was to create e-way bill based on the data provided in excel and send a email to client with created e-way bill numbers.

Roles and Responsibilities:

- Adopted Agile methodology for implementation.
- Performed needs and gaps analysis procedures and detailed data reviews to optimize implementation.
- Updated and maintained project documentation for detailed recordkeeping.
- Developed technical solutions to resolve a range of problems.
- Discussed requirements and processes with project managers and Clients.
- Created end to end automation with the help of UiPath tool.
- Used Web, Email and File automation to develop this process.
- Attended daily status call with client, shared status report.

Software Engineer
Exilant Technologies

Oct. 2015 – Feb 2018
Bengaluru, KA

Project 1: - Purchase Control:

- **Client** : Singhvi
- **Duration** : 7 months
- **Team Size** : 5
- **Technology** : RPA
- **Tools Used** : Blue prism, PDF

Description: Main objective of this project to check for the purchase order is in budget or not. Based on that we need to send approval or rejection mails. To check we need to follow certain conditions provided by Client.

Roles and Responsibilities:

- Adopted Agile methodology for implementation.
- Performed needs and gaps analysis procedures and detailed data reviews to optimize implementation.
- Updated and maintained project documentation for detailed recordkeeping.
- Discussed requirements and processes with project managers and Clients.
- Created end to end automation with the help of Blue prism tool.
- Used Web, Email and File automation to develop this process.
- Used Web, Email and file automation using Blue Prism
- Attended daily status call with client, shared status report.

Project 2: - Singapore Postal Services:

- **Client** : Singhvi
- **Duration** : 10 months
- **Team Size** : 8
- **Technology** : Selenium
- **Tools Used** : Selenium Web driver, Java

Description: Singapore Post is a web-based application which has been developed to manage mailing and courier services for the customer based in Singapore.

Roles and Responsibilities:

- Prepared and reviewed scenarios, test cases & test data.
- Designing scenario file for each requirement on basis of manual test cases.

- Created automation test scripts in the existing Hybrid framework.
- Completed automation of functional and regression scenarios.

Project 3: - Performance Evaluation (IO Selas Native):

- **Client** : Singhvi
- **Duration** : 3 months
- **Team Size** : 4
- **Technology** : Performance Testing
- **Tools Used** : JMeter , Blazemeter

Description: IO SELAS is project related to Medical representative. It is used to keep track of meetings, appointments, joining of new medical representatives. This is a native application for apple OS.

Roles and Responsibilities:

- Understand the non-functional requirements from business
- Analyzed the critical business scenarios
- Involved in test Execution, Monitoring and preparing reports
- Involved in analyzing the test result and preparing reports

Project 4: Fusion (RPA Tool):

- **Client** : Internal
- **Duration** : 10 months
- **Team Size** : 10
- **Technology** : Manual Testing, Regression testing, Functional Testing
- **Tools Used** : Jira, Excel

Description: Fusion contains multiple components that help to orchestrate the necessary automation on user's desktop. This is a Internal RPA tool.

Roles and Responsibilities:

- Responsible for writing the test cases and execution of test cases.
- Performed Functionality, System testing, Integration Testing, Smoke Testing.
- Tracked the defects and Prepared User Manual.
- Knowledge management and providing KT to new team member

Education

B.E: Electronics & communication Engineering

Gwalior Institute of Technology (RGTU)

Gwalior

Higher Secondary: Science & Math as specialization

CBSE

Patna, BR

Senior Secondary: Advance mathematics as specialization

CBSE

Patna, BR

Professional Enhancement

- Successfully Completed Certification in Blue prism and UiPath
- Provided training for UiPath and Blue prism

Personal Details

Date of Birth: 10th August,1991

Languages Known: English, Hindi

Mahi Trainer

Infrastructure Engineer & Architect

Personal Info

E-mail

mahi.trainer@gmail.com

Skills

Netapp 7-mode Administration

Netapp C-mode Administration

Netapp C-mode ONTAP 9.0
Performance Troubleshoot

AWS Solutions Architect Associate

I work as an Cloud and Datacenter Architect/Engineer for a large Services firm handling multiple clients in providing Datacenter based Storage/Backup technologies and AWS Cloud solutions. My role includes understanding the client business needs, converting to technical requirements, build a suitable solution, implement and provide L3 troubleshooting.

My expertise on Storage Technologies is majorly Netapp and also EMC to assist with overall issue troubleshooting and provide quick resolution.

Experience

2008 to
present

Cloud and Datacenter Engineer/Architect

Current Company

I've trained and provided teaching assistance to hundreds of working professionals through both Online and Corporate Trainings covering Netapp, EMC and VMware technologies. Due to my thorough experience in Datacenter technologies, also added Cloud technology (AWS) to my based and working on the same since last 18 months. Provided training sessions for AWS Solutions Architect Associate.

- 10 years of experience in NETAPP and EMC storage systems architecture, installation, implementation, integration, security and administration in local & Geo-DR remote environments.
- Lead the project for Engineering the solution of 7-mode to C-mode transition and migrating data that included using 7MTT for NAS Volume migrations and WFA for SAN volume migrations.
- Storage Lead for Data Center moves and consolidations for two locations involving 80TB of Netapp storage.
- Troubleshooting and managing CIFS Shares, NFS exports; Qtree and Quotas management.
- Excellent experience in Engineering and Designing the base architecture and configuration, administrating, maintaining and troubleshooting of Netapp FAS and AFF (7-mode and C-mode), EMC-VMAX, EMC-VNX, VPLEX, Isilon and Clariion systems.
- Deployed and configured multiple instances of Storage tools including OCUM, OPM, WFA, 7MTT for Netapp; SYMCLI, SMI-S and Unisphere for VMAX Arrays.
- Lead Engineer/ Architect from developing requirements for Storage and its connected hardware Monitoring/Reporting Alerting tools to creating Design configuration, implementation, setup and support them for Netapp Command Insight and EMC Vopr SRM.
- Good Knowledge of virtualization (VMWare), Install, maintains, and supports VMware (ESX Servers).
- Troubleshoot and resolve the Storage related issues generated in production, Development and testing environments.
- Responsible for providing Engineering Solutions and handling a large Netapp Storage Environment including all protocols, DR, TIER 3 support.
- Responsible for managing different kinds of AFF 8040 and FAS series 6xxx, 3xxx in SAN/NAS environment. Responsible for production support operations for shared and dedicated clients.
- Provide end to end performance troubleshooting and analysis per hour basis when the application teams enquire about slowness.
- Worked on identifying Storage KPI's (capacity, performance and availability) to monitor/report and alert on – defined a RACI model for the same. Integrated OCUM and OPM to setup SNMP alerting.

- Storage Capacity planning to ensure having sufficient headroom for Organic Growth and planned projects and budgeting capacity and upgrades/New installs for future growth based on historical usage and upcoming projects.
- Deployment, Setup and handling ongoing upgrades for new features/enhancements for Netapp monitoring tools including OCUM and OPM.
- Troubleshooted performance issue on Netapp using sysstat output. Generated perfstat on the filer for troubleshooting the Netapp filer performance issues. Enable the VIF interfaces when they are down. Managing takeover and giveback for Active/Active Configuration.

- Professional with 2 years of experience in AWS design, development and cloud implementation.
- Cognitive about designing, deploying and operating highly available, scalable and fault tolerant systems using Amazon Web Services (AWS).
- Extensively worked using AWS services along with wide and in depth understanding of each one of them.
- Highly skilled in deployment, data security and troubleshooting of the applications using AWSservices.
- Proficient in writing Cloud Formation Templates (CFT) in YAML and JSON format to build the AWSservices with the paradigm of Infrastructure as a Code.
- Experienced with event-driven and scheduled AWS Lambda functions to trigger various AWSresources.
- Experienced with installation of AWS CLI to control various AWS services through SHELL/BASH scripting.
- Experienced in writing complex SQL queries and scheduled tasks using cron jobs.
- Good knowledge in relational and NoSQL databases like MySQL, SQLServer, Oracle, DynamoDB, MongoDB.
- Proficient in AWS services like VPC, EC2, S3, ELB, AutoScalingGroups(ASG), EBS, RDS, IAM, CloudFormation, Route 53, CloudWatch, CloudFront, CloudTrail.
- Used security groups, network ACL's, internet gateways and route tables to ensure a secure zone for organization in AWS public cloud.
- Created and configured elastic load balancers and auto scaling groups to distribute the traffic and to have a cost efficient, fault tolerant and highly available environment.
- Created S3 buckets in the AWS environment to store files, sometimes which are required to serve static content for a web application.
- Possess good knowledge in creating and launching EC2 instances using AMI's of Linux, Ubuntu, RHEL, and Windows and wrote shell scripts to bootstrap instance.
- Used IAM for creating roles, users, groups and also implemented MFA to provide additional security to AWS account and its resources.
- Created EBS volumes for storing application files for use with EC2 instances whenever they are mounted to them.
- Experienced in creating RDS instances to serve data through servers for responding to requests.
- Created snapshots to take backups of the volumes and also images to store launch configurations of the EC2 instances.
- Written Templates for AWS infrastructure as a code using Terraform to build staging and production environments.

8/8/2020 13:12:44	Vibha Parmaj	vibhaparmaj9@gmail.com	9845325278	Belgaum	Karnataka	PeopleTree Education Society, Belgaum	I'm waiting for some more FDPs more informative to the passing out students this year from technical background (BCA). N also career opportunities and better domains for career.	Paypal	Cloud Computing	Internet of Things	Robotic Process Automation	Both (1) and (2)	Wallet
8/8/2020 13:12:46	SAIRAMAN SRINIVASAN	saiauro99@gmail.com	9600085724	Chennai	TamilNadu	Consortium For Technical Education	Very thing was well organised.	Litecoin	Cloud Computing	Internet of Things	Robotic Process Automation	Both (1) and (2)	Wallet
8/8/2020 13:12:50	MANJUNATH S K	manjunathsk.rvim@rvei.edu.in	9945578825	Bangalore	Karnataka	RV INSTITUTE OF MANAGEMENT	Very well organised..	Paypal	Remote Invocation	Internet of Things	Robotic Process Automation	Both (1) and (2)	Wallet
8/8/2020 13:12:50	Mohd Zeeshan Athani	zeeshan_athani@rediffmail.com	9731168924	Bengaluru	Karnataka	R.V. Institute of Management	I would like to be a part of a webinar based on affiliate marketing. Sessions can be improved by giving more opportunities to students to interact with the speaker. Overall the sessions are good.	Paypal	Cloud Computing	Internet of Things	Robotic Process Automation	Both (1) and (2)	Bank account
8/8/2020 13:13:15	Dr. Padmalini Singh	singhpadmalini@gmail.com	9019452125	Bangalore	Karnataka	RV Institute of Management	Good choice of Expert Panels	Paypal	Cloud Computing	Internet of Things	Robotic Process Automation	Both (1) and (2)	Wallet
8/8/2020 13:13:32	Shreya Ramachandra	shreyagowda1612@gmail.com	9901056839	Ramanagar	Karnataka	Visvesvaraya technological university	Some more technical terms to be included	Paypal	Cloud Computing	Internet of Things	Robotic Process Automation	Both (1) and (2)	Wallet
8/8/2020 13:13:49	Keerti Patil	Keertipati30@gmail.com	9742473397	Banglore	Karnataka	RVIM	-	Paypal	Cloud Computing	Internet of Things	Robotic Process Automation	Both (1) and (2)	Wallet
8/8/2020 13:13:53	Dr. A. Narasima Venkatesh	dr.a.narasimavenkatesh@gmail.com	9110464380	Bangalore	Karnataka	R V Institute of Management	Very Informative FDP.	Paypal	Cloud Computing	Internet of Things	Robotic Process Automation	Both (1) and (2)	Wallet
8/8/2020 13:14:35	Anupama S. M	anupama219@rediffmail.com	9739697154	Bangalore	Karnataka	R V Institute of Management	No comments	Paypal	Cloud Computing	Internet of Things	Robotic Process Automation	Both (1) and (2)	Wallet
8/8/2020 13:14:50	Sheela hegde	hegadesheelaa@gmail.com	09663695543	BENGALUR	KARNATAK	RV Institute of management	Nothing	Etherium	Cloud Computing	Internet of Things	Robotic Process Automation	Machine Learning	Bank account
8/8/2020 13:15:01	Akshatha Bopaiah M	akshathabopaiah@gmail.com	08105066141	Kodagu	Karnataka	RV INSTITUTE OF MANAGEMENT	It was good..	Paypal	Cloud Computing	Internet of Things	Robotic Process Automation	Both (1) and (2)	Wallet
8/8/2020 13:15:42	Archana V	archanaanitha1@gmail.com	7204619153	Bangalore	Karnataka	R V Institute of Management	-	Paypal	Cloud Computing	Internet of Things	Robotic Process Automation	Both (1) and (2)	Floppy Disk
8/8/2020 13:15:44	Shivakumar H C	shivakumar.rvim@rvei.edu.in	8147464481	Bengaluru	Karnataka	RV Institute of Management	Wonderfully Organised, No Suggestions	Paypal	Cloud Computing	Internet of Things	Robotic Process Automation	Both (1) and (2)	Wallet
8/8/2020 13:15:46	Deeksha K	deekshak1198@gmail.com	09731549911	Bangalore	KARNATAK	RV Institute of Management	It was very informative.	Bitcoin	Cloud Computing	Internet of Things	Robotic Process Automation	Both (1) and (2)	Wallet
8/8/2020 13:15:59	Sowmya D S SUBRAMANYA G	sowmyads.rvim@rvei.edu.in subramanyagovindaraj7@gmail.com	9740165784	Bangalore	Karnataka	R V Institute of Management	Pis share the reading materials and recordings of the FDP	Paypal	Cloud Computing	Internet of Things	Robotic Process Automation	Both (1) and (2)	Wallet
8/8/2020 13:16:14	Ashwathi Sundaram	ashwathisundaram16@gmail.com	9844649626	DAVANGER	KARNATAK	GMIT	Nothing	Paypal	Cloud Computing	Internet of Things	Robotic Process Automation	Both (1) and (2)	Wallet
8/8/2020 13:16:57	Ashwathi Sundaram	ashwathisundaram16@gmail.com	+918861491005	Bangalore	Karnataka	RV Institute of Management	Good job.	Paypal	Cloud Computing	Internet of Things	Robotic Process Automation	Both (1) and (2)	Wallet
8/8/2020 13:17:16	Akshatha Bopaiah M	akshathabopaiah@gmail.com	08105066141	Kodagu	Karnataka	RV INSTITUTE OF MANAGEMENT	The session was very knowledgable.	Paypal	Cloud Computing	Internet of Things	Robotic Process Automation	Both (1) and (2)	Wallet
8/8/2020 13:17:27	Nikita L	nikitalohi49@gmail.com	8762568272	Bangalore	Karnataka	RV Institute of Management Bangalore	Well presented by the entire panel	Paypal	Cloud Computing	Internet of Things	Robotic Process Automation	Both (1) and (2)	Wallet

8/8/2020 13:18:32	Tejashwini S	tejashwini.shivu29@gmail.com	9945727583	Bangalore	Karnataka	RV Institute of Management	-	Litecoin	Cloud Computing	Internet of Things	Robotic Process Automation	Both (1) and (2)	Wallet
8/8/2020 13:18:36	Dr. G. P. Nagesh	gpnagesh27@gmail.com	9110692983	Shivamogga	Karnataka	Kuvempu university	Some core finance topics blend of technology support may be taken.	Paypal	Remote Sensing	Internet of Things	Robotic Process Automation	Both (1) and (2)	Bank account
8/8/2020 13:19:01	Smeeta Patil	smeetakpatil07@gmail.com	7259816967	Ron	Karnataka	R V Institute of Management	Over all it was good it was knowledgeable session.	Paypal	Cloud Computing	Internet of Things	Robotic Process Automation	Both (1) and (2)	Wallet
8/8/2020 13:19:35	Deena k	deenakrishna97@gmail.com	9844245971	Hassan	Karnataka	RV Institute of Management		Paypal	Cloud Computing	Internet of Things	Robotic Process Automation	Both (1) and (2)	Wallet
8/8/2020 13:20:10	Sandeshsavak S	sandeshsavak@gmail.com	9900276843	Bangalore	Karnataka	RV Institute of Management	No	Litecoin	Cloud Computing	Internet of Things	Robotic Process Automation	Both (1) and (2)	Wallet
8/8/2020 13:20:11	Nikitha Sreekantha	nikithasreekantha74@gmail.com	9886434746	Bangalore	Karnataka	Dayananda Sagar Business Academy	Professionally organised FDP. Excellent Moderators. Hats off to Dr. Bung & Team	Paypal	Cloud Computing	Internet of Things	Robotic Process Automation	None of the above	Wallet
8/8/2020 13:21:20	Lathashree S	lathashree31@gmail.com	9741354577	Bangalore	Karnataka	R V INSTITUTE OF MANAGEMENT	It was informative session	Paypal	Cloud Computing	Internet of Things	Robotic Process Automation	Both (1) and (2)	Wallet
8/8/2020 13:22:40	Hanisha Tadavarthy	hanishatadavarthy98@gmail.com	8867119968	Banglore	Karnataka	R V INSTITUTE OF MANAGEMENT	No	Paypal	Cloud Computing	Internet of Things	Robotic Process Automation	Both (1) and (2)	Wallet
8/8/2020 13:23:36	Ganapati Janardhan Bhat	rganapati6@gmail.com	8150906458	Kumta	Karnataka	R V Institute of Management		Paypal	Cloud Computing	Internet of Things	Robotic Process Automation	Both (1) and (2)	Wallet
8/8/2020 13:23:47	Amarnath P M	amarnathpujarim@gmail.com	+918499957729	Hindupur	Andhra Pradesh	R V INSTITUTE OF MANAGEMENT		Paypal	Cloud Computing	Internet of Things	Robotic Process Automation	Both (1) and (2)	Wallet
8/8/2020 13:25:31	B Vasavi	bvasavisweety@gmail.com	8904517892	Hindupur	Andhra Pradesh	RV institute of management	None	Paypal	Cloud Computing	Internet of Things	Robotic Process Automation	Both (1) and (2)	Wallet
8/8/2020 13:25:56	Sushmitha D.R	sushmitharamanath@gmail.com	9740109400	Bangalore	Karnataka	RV institute of management		Paypal	Cloud Computing	Internet of Things	Robotic Process Automation	Both (1) and (2)	Wallet
8/8/2020 13:26:13	Arun Raveendra Bhat	aranbhat.bhat@gmail.com	08277612604	Bangalore	Karnataka	R V Institute of Management	Nothing	Paypal	Cloud Computing	Internet of Things	Robotic Process Automation	Both (1) and (2)	Wallet
8/8/2020 13:26:25	Deepak Desai	deepakdesai511@gmail.com	7795784815	Hospet	Karnataka	RV institute of management	No suggestions its good	Paypal	Cloud Computing	Internet of Things	Robotic Process Automation	Both (1) and (2)	Wallet
8/8/2020 13:27:12	Shravya S Shetty	shettyshravya1996@gmail.com	9867151007	Mumbai	Maharashtra	R V Institute of Management	More case studies	Paypal	Cloud Computing	Internet of Things	Robotic Process Automation	Both (1) and (2)	Bank account
8/8/2020 13:29:49	Akshatha M L	akshatham26@gmail.com	9739071231	Sagar	Karnataka	RV institute of management of	I want some more sessions on analytics, iot	Paypal	Cloud Computing	Internet of Things	Robotic Process Automation	Both (1) and (2)	Wallet
8/8/2020 13:31:08	Dr (Brig) Sandes	principal@dsba.edu.in	9886434746	Bangalore	Karnataka	Dayananda Sagar Business Academy	Please avoid 2nd Saturday, Atleast 1 day should have resource person from Abroad. Introduction should be minimum. Overall good.	Paypal	Cloud Computing	Internet of Things	Robotic Process Automation	None of the above	Wallet
8/8/2020 13:34:39	Sandesh Shridhar Shet	sandeshshet01@gmail.com	9743857897	Honnavar	Karnataka	R V INSTITUTE OF MANAGEMENT	Provide more FDPs on management	Paypal	Cloud Computing	Internet of Things	Robotic Process Automation	Both (1) and (2)	Wallet
8/8/2020 13:38:11	Chiraag M	chiraagm2020@gmail.com	7349734948	Banglore	Karnataka	R v institute of Management	No suggestion it was very helpful	Paypal	Cloud Computing	Internet of Things	Robotic Process Automation	Both (1) and (2)	Wallet
8/8/2020 13:39:16	Thejasvi N	thejasvinitk@gmail.com	+919738663055	Banglore	Karnataka	R V INSTITUTE OF MANAGEMENT	Nil	Paypal	Cloud Computing	Internet of Things	Robotic Process Automation	Both (1) and (2)	Wallet

Timestamp	Name of the Participant (To be printed in the certificate)	Email id	Contact number	City	State	Name of the School/University/Institute/Corporate House	Your suggestions for improving future FDPs	Which of the following is not a Cryptocurrency?	is a paradigm of distributed computing to provide the customers on-demand, utility based computing service.	What is the full form of IOT?	What is the full form of RPA?	Which of the following are comprised within AI?	Where do you store your cryptocurrency?
8/4/2020 16:06:19													
8/8/2020 12:16:14	Nagasubba Reddy	nnsreddy.rvim@rvei.edu.in	9845492336	Bangalore	Karnataka	RVIM	Excellent	Bitcoin	Cloud Computing	Internet of Things	Robotic Process Automation	Both (1) and (2)	Bank account
8/8/2020 13:01:41	Sowjanya Bhat B	sowjanyaabhat1997@gmail.com	8970115118	Bangalore	Karnataka	R V Institute of Management	Nothing	Paypal	Cloud Computing	Internet of Things	Robotic Process Automation	Both (1) and (2)	Bank account
8/8/2020 13:02:27	Karthik N D	n.dkarthik98@gmail.com	7259129933	Bangalore	Karnataka	R V Institute of Management	None	Paypal	Cloud Computing	Internet of Things	Robotic Process Automation	Both (1) and (2)	Bank account
8/8/2020 13:03:05	Arpitha s	sarpitha975@gmail.com	9739694599	Bangalore	Karnataka	RVIM	wonderful session	Paypal	Cloud Computing	Internet of Things	Robotic Process Automation	Both (1) and (2)	Bank account
8/8/2020 13:03:09	Shreya Satish Deshpande	shreyadeshpande1998@gmail.com	8967220512	Bangalore	Karnataka	RV Institute of Management	None	Paypal	Cloud Computing	Internet Operational Thing	Robotic Process Automation	Both (1) and (2)	Bank account
8/8/2020 13:03:23	Shiva Prasad Dr	search4shivassp@gmail.com	8105885854	Pavagada	Karnataka	Rv institute of management	Overall good and interactive sessions, no need of change, just go with this flow and educate the public, learned many things Thanks a lot Director sir..	Paypal	Cloud Computing	Internet of Things	Robotic Process Automation	Both (1) and (2)	Wallet
8/8/2020 13:03:34	Mahesha.S	maheshas2694@gmail.com	+918861573232	Bangalore	Karnataka	RV INSTITUTE OF MANAGEMEN T	Looking forward for more such webinars	Paypal	Cloud Computing	Internet of Things	Robotic Process Automation	Both (1) and (2)	Wallet
8/8/2020 13:03:49	Varja Madhuranath	varjamadhuranath1996@gmail.com	9900347057	Bangalore	Karnataka	R V Institute of Management	-	Etherium	Cloud Computing	Internet of Things	Robotic Process Automation	Machine Learning	Wallet
8/8/2020 13:04:26	Lokesh MG	arunlokes98@gmail.com	8217036546	Bangalore	Karnataka	R V Institute of Management	Include more programs	Paypal	Cloud Computing	Internet of Things	Robotic Process Automation	None of the above	Bank account
8/8/2020 13:04:49	Sandesh Shridhar Shet p	sandeshshet01@gmail.com	9743857897	Honnavar	Karnataka	RV INSTITUTE OF MANAGEMEN T	It's good session	Paypal	Cloud Computing	Internet of Things	Robotic Process Automation	Both (1) and (2)	Wallet
8/8/2020 13:05:01	Ramya R	ramyaraju3698@gmail.com	9742189513	Bangalore	Karnataka	Rv institute of management		Paypal	Cloud Computing	Internet Operational Thing	Robotic Process Automation	Both (1) and (2)	Floppy Disk
8/8/2020 13:05:21	UdayaRaviKanth KV	udayravi9urk@gmail.com	0	Bangalore	Karnataka	RV INSTITUTE OF MANAGEMEN T	Very nice session	Paypal	Cloud Computing	Internet of Things	Robotic Process Automation	Both (1) and (2)	Wallet
8/8/2020 13:05:51	Karan SK	karansk38@gmail.com	8660199195	Hassan	Karnataka	RV Institute of Management		Paypal	Cloud Computing	Internet of Things	Robotic Process Automation	Both (1) and (2)	Wallet
8/8/2020 13:06:17	Sravanthi T	sravanthitatineni04@gmail.com	9632899669	Ballari	Karnataka	RV INSTITUTE OF MANAGEMEN T	Nothing	Paypal	Cloud Computing	Internet of Things	Robotic Process Automation	Both (1) and (2)	Wallet
8/8/2020 13:06:18	Mahesha.S	maheshas2694@gmail.com	+91886157323	Bangalore	Karnataka	RV INSTITUTE OF MANAGEMEN T	Looking forward for more such webinars	Paypal	Cloud Computing	Internet of Things	Robotic Process Automation	Both (1) and (2)	Wallet
8/8/2020 13:06:53	Sainath Vinayak Kulkarni	sainathkulkarni97@gmail.com	9611964405	Bengaluru	Karnataka	RV Institute Of Management	It was a good sessions	Paypal	Cloud Computing	Internet of Things	Robotic Process Automation	Both (1) and (2)	Floppy Disk
8/8/2020 13:06:54	PAVITHRA S T	pavithrast.rvim@rvei.edu.in	9902165590	Bangalore	Karnataka	R V Institute of Management	GOOD	Paypal	Cloud Computing	Internet of Things	Robotic Process Automation	Both (1) and (2)	Wallet
8/8/2020 13:07:04	Shreya Ramachandra	shreyagowda1612@gmail.com	9901056839	Ramanagar	Karnataka	Visvesvaraya technological university	Little focus towards technical terms	Paypal	Cloud Computing	Internet of Things	Robotic Process Automation	Both (1) and (2)	Wallet
8/8/2020 13:07:07	Dr. Shilpa Ajay	shilpa.ajay@nmit.ac.in	9900447462	Bangalore	Karnataka	Nitte Meenakshi Institute of Technology	Good session	Paypal	Cloud Computing	Internet of Things	Robotic Process Automation	Both (1) and (2)	Wallet

8/8/2020 13:07:18	Keerthan Kamath	keerthan.kamath.45@gmail.com	7760418092	Kundapur	Karnataka	R.V Institute of Management on	No suggestions	Paypal	Remote Invocation	Internet of Things	Robotic Process Automation	Both (1) and (2)	Wallet
8/8/2020 13:07:24	Ramya S	ramyas.rvim@rvei.edu.in	9741849806	Bangalore	Karnataka	RV Institute of Management	Great FDP	Paypal	Cloud Computing	Internet of Things	Robotic Process Automation	Both (1) and (2)	Wallet
8/8/2020 13:07:48	Syed Asif Pasha	pashasif30@gmail.com	7019048592	Bangalore	Karnataka	R V Institute Of Management	More such FDPs on emerging technologies and specifically on Blockchain technology	Paypal	Cloud Computing	Internet of Things	Robotic Process Automation	Both (1) and (2)	Wallet
8/8/2020 13:08:18	Kuberanand N	Kuberakushi007@gmail.com	9945464538	Bangalore	Karnataka	Rv institute of management	It was gud	Paypal	Cloud Computing	Internet of Things	Robotic Process Automation	Both (1) and (2)	Wallet
8/8/2020 13:08:19	Karthik M	7karthik.m@gmail.com	9900741401	Bengaluru	Karnataka	RV Institute of Management	Thanks for Team RVIM	Paypal	Cloud Computing	Internet of Things	Robotic Process Automation	Both (1) and (2)	Wallet
8/8/2020 13:08:24	Prajna Pramanik	prajnapramanik98@gmail.com	8482017955	Bangalore	Karnataka	R V Institute of Management	Grateful to have such opportunities.	Paypal	Remote Sensing	Internet of Things	Robotic Process Automation	Both (1) and (2)	Wallet
8/8/2020 13:08:54	Shreya Shahapurkar	shahapurkar.shreya123@gmail.com	+918867145075	Jayanagar	Karnataka	R V institute of Management Bangalore	Great sessions	Paypal	Cloud Computing	Internet of Things	Robotic Process Automation	Both (1) and (2)	Wallet
8/8/2020 13:09:50	MUZAMMIL RIHAN	MUZZ007SHAIK@GMAIL.COM	8073626891	HUBBALLI	KARNATAKA	RV INSTITUTE OF MANAGEMEN T	All the suggestions gave me the idea and in depth of all the topics, THANKS to RVIM	Etherium	Cloud Computing	Internet of Things	Robotic Process Automation	Both (1) and (2)	Wallet
8/8/2020 13:09:50	Divyashree R	divyashree131298@gmail.com	7899919317	Bangalore	Karnataka	RV Institute of Management	No suggestions, these sessions were good and sufficient.	Paypal	Cloud Computing	Internet of Things	Robotic Process Automation	Both (1) and (2)	Wallet
8/8/2020 13:11:26	Bharath Kiran DV	bharathdvmurthy21@gmail.com	7676423766	Bangalore	Karnataka	R V Institute of Management	Thankyou for the opportunity, we are now exposed to other emerging technologies and can step explore more on the area of interest.	Paypal	Cloud Computing	Internet of Things	Robotic Process Automation	Both (1) and (2)	Wallet
8/8/2020 13:11:43	Bindu Priya	bindupriyasmdc@gmail.com	8123337714	Bellry	Karnataka	R V Institute of management	It was overall knowledgeable session	Paypal	Cloud Computing	Internet of Things	Robotic Process Automation	Both (1) and (2)	Wallet
8/8/2020 13:11:52	MALLIKARJUN.J	mallikarjunj6589@gmail.com	8884544018	Bengaluru	Karnataka	R V INSTITUTE OF MANAGEMEN T	Sessions are very much technical and a bit hard for commerce students, just attended because it was done mandatory.	Paypal	Cloud Computing	Internet of Things	Robotic Process Automation	Both (1) and (2)	Wallet
8/8/2020 13:11:56	chetan vijay	chetanvijay98@gmail.com	08884067776	Bangalore	karnataka	r v institute of management	n	Paypal	Remote Invocation	Internet Object Training	Robotic Process Automation	Deep Learning	Floppy Disk
8/8/2020 13:12:14	Nikhil K	nikhilnike131999@gmail.com	9739413285	Bangalore	Karnataka	R V Institute of Management	FDP was very interesting and informative and useful	Bitcoin	Cloud Computing	Internet of Things	Robotic Process Automation	Both (1) and (2)	Wallet
8/8/2020 13:12:19	Vidya V T	vidyavenut@gmail.com	8494915915	Bangalore	Karnataka	RV INSTITUTE OF MANAGEMEN T	Not sure	Etherium	Cloud Computing	Internet of Things	Robotic Process Automation	Both (1) and (2)	Bank account

8/8/2020 13:41:17	N B GOWTAMI	nbgowtami.naik18@gmail.com	8861821518	Sirsi, Uttar	Karnataka	RV INSTITUTE OF MANAGEMENT	Inclusion of more real time examples.	Paypal	Cloud Computing	Internet of Things	Robotic Process Automation	Both (1) and (2)	Wallet
8/8/2020 13:41:35	Salman pasha	salu2230@gmail.com	8618774474	Bangalore	Karnataka	Bangalore central university	had a great insights about the emerging technologies and bit more interactive	Paypal	Cloud Computing	Internet of Things	Robotic Process Automation	Both (1) and (2)	Wallet
8/8/2020 13:50:59	Dileep Satish Hegde	dileephegde1997@gmail.com	8105123488	Siddapur	Karnataka	RV Institute of Management		Paypal	Cloud Computing	Internet of Things	Robotic Process Automation	Both (1) and (2)	Wallet
8/8/2020 13:55:33	Srivalli N Gupta	srivalli21gupta@gmail.com	9845869343	Mysore	Karnataka	RV institute of management	It was good	Paypal	Remote Invocation	Internet of Things	Robotic Process Automation	Both (1) and (2)	Wallet
8/8/2020 14:09:24	Reshma subray Hegde	reshheg.21@gmail.com	9481940957	Sirsi	Karnataka	Rv institute of management Bangalore	No suggestions	Paypal	Remote Sensing	Internet of Things	Robotic Process Automation	Both (1) and (2)	Floppy Disk
8/8/2020 14:18:46	Yashaswini H.K	yashuhulimane@gmail.com	8762791799	Banglore	Karnataka	R V Institute of management	Nothing	Etherium	Cloud Computing	Internet of Things	Robotic Process Automation	Both (1) and (2)	Floppy Disk
8/8/2020 14:38:08	Clinton Joyan Roche	clintan_r@outlook.com	9844630217	Bangalore	Karnataka	R. V. Institute of Management	Make it such that all the participants would be able to interact.	Bitcoin	Cloud Computing	Internet of Things	Robotic Process Automation	Both (1) and (2)	Wallet
8/8/2020 14:41:38	Prajeeth A Goutham	prajeethgoutham@gmail.com	9738309068	Mysuru	Karnataka	RVIM	-	Paypal	Cloud Computing	Internet of Things	Robotic Process Automation	Both (1) and (2)	Wallet
8/8/2020 14:42:47	Suprita S Chatni	supchatni@gmail.com	+918884788664	Hubli	Karnataka	R V Institute Of Management, Bangalore	No suggestions	Paypal	Cloud Computing	Internet of Things	Robotic Process Automation	Both (1) and (2)	Wallet



RV Institute of Management®

Affiliated to Bengaluru Central University.

Approved by AICTE, New Delhi. Accredited by NAAC with A+ grade.

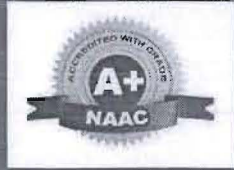

Rastreeya Sikshana Samithi Trust
R V Institute of Management

In association with

RV-SKILLS
CENTER FOR EMERGING TECHNOLOGIES



Certificate of Participation

This is to certify that,

Dr. Shilpa Ajay

has successfully participated in the 6 days FDP on “Emerging Technologies - A Way Forward” organized by R V Institute of Management, in association with RV-SKILLS, Bangalore, from 3rd August to 8th August, 2020.

Dr. Purushottam Bung
Professor and Director
R V Institute of Management

Mr. Venkatesh Prasad
CEO, RV-SKILLS



RV Institute of Management®

Affiliated to Bangalore Central University

Approved by AICTE, New Delhi. Accredited by NAAC with 'A+' grade.



Rastreeya Sikshana Samithi Trust
R V Institute of Management

In association with

RV-SKILLS
CENTER FOR EMERGING TECHNOLOGIES

Certificate of Participation

This is to certify that,

Dr.G.P Nagesh

has successfully participated in the 6 days FDP on “Emerging Technologies - A Way Forward” organized by R V Institute of Management, in association with RV-SKILLS, Bangalore, from 3rd August to 8th August, 2020.

Dr. Purushottam Bung
Professor and Director
R V Institute of Management

Mr. Venkatesh Prasad
CEO, RV-SKILLS



RV Institute of Management®

Affiliated to Bengaluru Central University

Approved by AICTE, New Delhi. Accredited by NAAC with 'A+' grade.

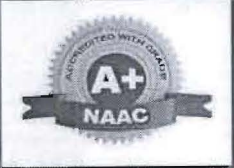

Rastreeya Sikshana Samithi Trust
R V Institute of Management

In association with

RV-SKILLS
CENTER FOR EMERGING TECHNOLOGIES



Certificate of Participation

This is to certify that,

Dr.A.Narasima Venkatesh

has successfully participated in the 6 days FDP on “Emerging Technologies - A Way Forward” organized by **R V Institute of Management**, in association with **RV-SKILLS**, Bangalore, from 3rd August to 8th August, 2020.

Dr. Purushottam Bung
Professor and Director
R V Institute of Management

Mr. Venkatesh Prasad
CEO, RV-SKILLS



**Four Day Continuing Education Programme on Commodity Derivatives
Conducted By
Finance Department**

Date: 1 st to 4 th September 2020	Venue: Webinar
Time: 3.00 pm to 5.00 pm	Event : CEP
No. of Participant: 254	Event Coordinator: Prof. Dileep & prof. Priya Jain

Objectives

- To understand the Indian and Global Commodity Derivatives
- To Analyze Hedging strategies of Futures and options Contracts for Commodities.
- To know Commodity market Operations and clearing & Settlement procedure followed by commodity market.

**Flow of the Event
Session Details**

Session 1	Introduction to derivatives. Types of derivative contracts. Benefits of commodity derivatives markets. History of commodity derivatives markets. Global and Indian market. Major commodities traded. Regulation of commodity markets in India.
Session 2	Risk Management with Commodity Futures. Trading in futures. Margin system. Market participants. Convergence and Basis Risk. Hedging strategies using futures. Spread Trading. Practical aspects of hedging. Pricing of futures contracts.
Session 3	Commodity options. Types of option contracts. Hedging using options. Pricing of option contracts. Option Greeks. Trading strategies using option contracts. Commodity options in Indian market.
Session 4	Commodity market operations. Trading in commodity futures and options. Exchange risk management tools. Clearing, settlement and delivery in commodity markets. Innovative products in commodity markets.

Outcome Achieved/ Attained:

Dr. Ajoy Kumar, the resource person explained with meaning and types of commodities and discussed the following:

The Commodity trading is as old as human history. Starting with the barter system, today it has become the backbone of global economy. The largest traded commodity in the world is crude oil in terms of value



(\$1.7 Trillion). The largest metal traded is gold in terms of value (\$0.17 Trillion) and iron in terms of volume.

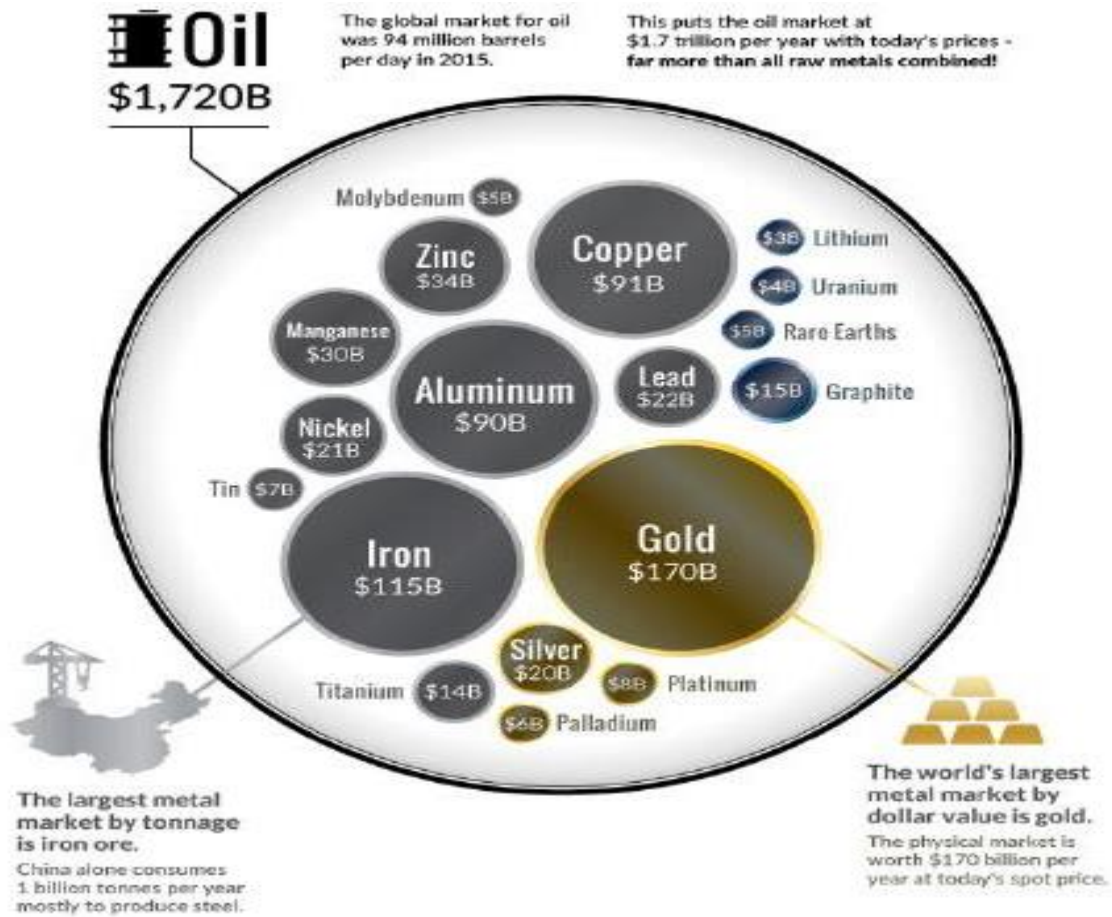

Functions of Commodity Derivatives Markets: Price Discovery, Risk Transfer, Market Completion

Types of Commodity Derivatives: Forward Contracts, Futures Contracts, Options Contracts, Swap Contracts.

Global Commodity Market

- Commodity derivatives are the oldest form of derivatives, while financial derivatives emerged much later
- Earliest instances of commodity derivatives were found in rice trading in Japan; tulip bulb trading in Amsterdam etc.
- Dojima Rice Exchange in Osaka, Japan established in 17th century, was the world's first commodity exchange. More structured trading started with establishment of Chicago Board of Trade (CBOT) in 1848.



Global Commodity Market

Table 17: Top 10 exchanges by number of commodity options and futures contracts traded in 2019

	Volume		Notional Value		Open interest	
	2019	YoY change	2019	YoY change	2019	YoY change
Shanghai Futures Exchange	1,411,969,733	20%	13,923,058	17%	5,748,273	37%
Dalian Commodity Exchange	1,355,584,225	38%	9,898,796	30%	9,686,951	113%
CME Group	1,133,124,055	-4%	60,597,611	-8%	24,486,658	-13%
Zhengzhou Commodity Exchange	1,092,486,045	34%	363,995	-93%	4,429,311	49%
Moscow Exchange	663,687,221	39%	450,110	47%	3,285,120	105%
ICE Futures Europe	482,608,092	-2%	23,296,908	-18%	13,491,751	2%
Multi Commodity Exchange of India	307,095,652	33%	1,108,564	18%	224,188	-34%
London Metal Exchange	176,260,936	-5%	17,939,963	14%	2,427,423	8%
ICE Futures US	92,613,557	-68%	2,020,422	-4%	3,094,748	5%
Borsa Istanbul	58,571,990	163%	11,751	195%	481,607	76%
Others	52,224,496	33%	706,864	60%	4,311,748	104%
Total	6,826,226,002	15.9%	130,318,041	-6%	71,667,778	15%

Source: WFE's Derivatives Report 2019

After the basics of Commodities the resource person discussed hedging with Futures and Options strategies and discussed the following;

Hedging with Futures Contract

Hedging for a Buyer (Long Hedge)

Case 1: Rising Prices

Commodity: Copper

01-09-2020: Buy (Long) October Futures Contracts at Rs.525/kg

30-10-2020: The October Futures and Spot Price are Rs.535/kg

Loss in Spot Market $(525-535) = (10)$

Profit in Futures Market $(535-525) = 10$

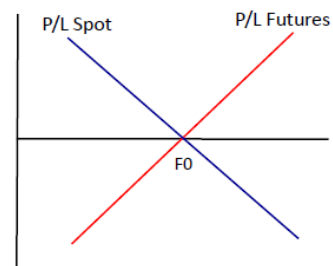

Hedging for a Buyer (Long Hedge)

Case 2: Falling Prices

Commodity: Copper

01-09-2020: Buy (Long) October Futures Contracts at Rs.525/kg

30-10-2020: The October Futures and Spot Price are Rs.520/kg

Profit in Spot Market $(525-520) = 5$

Loss in Futures Market $(520-525) = (5)$

Practical Issues

Hedging for a Buyer (Long Hedge)

Commodity: Copper

01-09-2020: Buy (Long) October Futures Contracts at Rs.525/kg

The maturity of the contract is 30-10-2020

Practical Issue 1: The hedger wants to actually buy copper on 10-10-2020

Practical Issue 2: The contract size is 2.5 MT. The hedger wants to buy 3.5 MT

Practical Issue 3: The delivery centre is Thane, but the hedger wants it at Bangalore

Practical Issue 4: The futures are on Grade A Copper Cathodes, but the hedger wants different grade

Practical Issue 1: Date Mismatch

Practical Issue 2: Quantity Mismatch

Practical Issue 3: Location Mismatch

Practical Issue 4: Quality (Asset) Mismatch (Cross Hedging)

Unhedged position is exposed to **Price Risk** and a hedged position is exposed to **Basis Risk**

Option Contracts

A contract between two parties, where the buyer of the option contract gets an option to buy or sell the underlying asset on or before a specified future date at a price agreed upon while entering the contract

Buyer/holder of an Option – **LONG** Position

Seller/writer of an Option – **SHORT** Position

Buyer of option need not necessarily be the buyer of the underlying asset; this depends on the type of the option

Call Option: Option to buy the underlying asset

Put Option: Option to sell the underlying asset

European Style Option: Exercised only on maturity

American Style Option: Exercise anytime till maturity

Options Trading Strategies

Bull Call Spread

Expectation: Bullish

Strategy:

Buy one ITM Call

Sell one OTM Call



Bear Put Spread

Expectation: Bearish

Strategy:

Buy one ITM Put

Sell one OTM Put

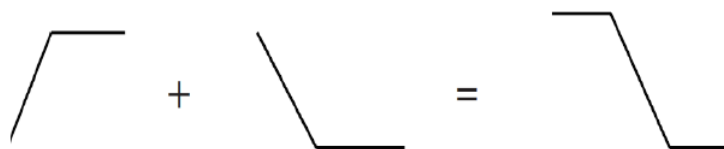

And finally Mr. Shrikant Koundinya discussed about, Trading on Commodity Exchange, Exchange Risk Management Tool, Position limit, Clearing & Settlement and Online MCX Exchange trading.

Trading Platform



- Automated screen-based trading
- National reach
- Trading Session: Agri-Commodities & Others/Daylight saving hours
- Transparent, objective and fair system for automatic order matching
- Identity of the trader undisclosed
- Flexibility for placing orders
- Price Quotation in Rupees
- Square-off facility

Instru...	U/L Asset	Symbol	Series/Exp...	SCSI	Price Q.	T.Tr.	Buy Qty	Buy Price	Sell Price	Sell Qty	Last Update Time	Last Traded Time	LTP
FUTCOM	COPPER	COPPER	30SEP2020	A	1 KGS	INR	3000 KGS	518.00	518.05	15000 KGS	03:21:11 PM 04/09/2020	03:21:08 PM 04/09/2020	518.00
FUTCOM	COPPER	COPPER	30OCT2020	A	1 KGS	INR	2500 KGS	514.40	514.45	2500 KGS	03:21:08 PM 04/09/2020	03:21:08 PM 04/09/2020	514.45
FUTCOM	COPPER	COPPER	27NOV2020	A	1 KGS	INR					12:53:47 PM 04/09/2020		
FUTCOM	CRUDE OIL	CRUDEOIL	21SEP2020	A	1 BBL	INR	10700 BBL	3053.00	3054.00	5600 BBL	03:21:11 PM 04/09/2020	03:21:07 PM 04/09/2020	3053.00
FUTCOM	CRUDE OIL	CRUDEOIL	19OCT2020	A	1 BBL	INR	100 BBL	3091.00	3093.00	300 BBL	03:21:11 PM 04/09/2020	03:10:30 PM 04/09/2020	3093.00
FUTCOM	CRUDE OIL	CRUDEOIL	19NOV2020	A	1 BBL	INR					10:18:21 AM 04/09/2020		
FUTCOM	GOLD	GOLD	05OCT2020	A	10 GRMS	INR	2 KGS	50860.00	50879.00	2 KGS	03:21:11 PM 04/09/2020	03:21:10 PM 04/09/2020	50870.00
FUTCOM	GOLD	GOLD	04DEC2020	A	10 GRMS	INR	2 KGS	51081.00	51128.00	1 KGS	03:21:10 PM 04/09/2020	03:02:24 PM 04/09/2020	51078.00
FUTCOM	GOLD	GOLD	05FEB2021	A	10 GRMS	INR	1 KGS	51296.00	51423.00	1 KGS	03:21:10 PM 04/09/2020		
FUTCOM	COTTON	COTTON	30OCT2020	A	1 BALES	INR	25 BALES	17520.00	17540.00	25 BALES	03:16:53 PM 04/09/2020	03:11:25 PM 04/09/2020	17540.00
FUTCOM	COTTON	COTTON	31DEC2020	A	1 BALES	INR	25 BALES	17210.00	17610.00	25 BALES	03:15:11 PM 04/09/2020		
FUTCOM	COTTON	COTTON	27NOV2020	A	1 BALES	INR	25 BALES	17390.00	17490.00	25 BALES	03:15:23 PM 04/09/2020	03:15:11 PM 04/09/2020	17390.00
FUTCOM	LEAD	LEAD	30SEP2020	A	1 KGS	INR	10 MT	152.65	152.75	15 MT	03:21:10 PM 04/09/2020	03:19:42 PM 04/09/2020	152.75

Feedback & Coordinator Comment:

The entire program from Day 1 to Day 4 all the participant actively participated and well received by all the participants and lots of appreciation to resource person and RVIM team from the participants. Many of them requested to conduct such programme in the future.

Event Coordinators

Director Prof.

Dileep S

Prof. Priya Jain

Annexure 1	Proposal / Approval
Annexure 2	Brochure of the event
Annexure 3	Brief profile of the speaker
Annexure 4	Attendees list
Annexure 5	Photo Gallery
Annexure 6	Detail Feedback (if required)

**Annexure 1
Proposal / Approval**

Date: 24th August 2020

From
Dileep
Assistant Professor,
R V Institute of Management, Bangalore

To
The Director
R V Institute of Management, Bangalore

Respected Sir,

**Sub: Proposal to conduct Four Day "Continuing Education Programme (CEP) on
Commodity Derivatives" on 01 -04 September, 2020**

The Finance Department of RVIM, request for approval to conduct four day "Continuing Education Programme (CEP) on Commodity Derivatives" on 01 to 04 September, 2020. The Resource Persons are;

1. Dr. M Ajoy Kumar, Associate Professor, SIT, Tumakuru and
2. Mr. Shrikant Koundinya, currently leads the Training & Education function at the MCX

Timing of the Programme is 3.00 pm to 5.00 pm

Session Details

	Topic
Session 1	Introduction to derivatives.
Session 2	Risk Management with Commodity Futures.
Session 3	Commodity options.
Session 4	Commodity market operations.

The above said programme may incurred the expenses of Rs. 6,000/- (Honorarium for resource person is Rs. 5,000/- and other Expenses Rs. 1,000/-). This is for your kind consideration and approval.

Thanking You

Truly Yours

Prof. Dileep

A/cg

24/8

**Annexure 2
Brochure of the Event**



RV Institute of Management®

FOUR DAY CONTINUING EDUCATION PROGRAMME ON
COMMODITY DERIVATIVES



Dr. M Ajoy Kumar
ASSOCIATE PROFESSOR,
SIT, TUMAKURU

 **1st to 4th September 2020**

 **03:00 PM - 05:00 PM**



RV Institute of Management®

FOUR DAY CONTINUING EDUCATION PROGRAMME ON
COMMODITY DERIVATIVES



Mr. Shrikant Koundinya
FCMA, CGMA

 **1st to 4th September 2020**

 **03:00 PM - 05:00 PM**



RV Institute of Management®

FOUR DAY CONTINUING EDUCATION PROGRAMME ON
COMMODITY DERIVATIVES

Moderator



Dr. Purushottam Bung
PROFESSOR & DIRECTOR,
RVIM



RV Institute of Management®

SESSION DETAILS

SESSION 1 SEP 1 st	INTRODUCTION TO DERIVATIVES
SESSION 2 SEP 2 nd	RISK MANAGEMENT WITH COMMODITY FUTURES
SESSION 3 SEP 3 rd	COMMODITY OPTIONS
SESSION 4 SEP 4 th	COMMODITY MARKET OPERATIONS

Annexure 3

Brief Profile of the Resources Persons

Dr. M AJOY KUMAR

- Has 25 years of academic experience
- Associate Professor at Siddaganga Institute of Technology, Tumakuru since September, 1998
- Worked as Academic Associate in the Finance & Accounting Area of Indian Institute of Management Ahmedabad (IIMA) (1996-98)
- Finance Officer of a World Bank funded project of MHRD worth Rs.250 million at SIT, Tumakuru (2005-2015)
- Areas of specialization include financial and commodity markets, derivatives and cost management
- Published research papers in the areas of commodity derivatives, stock market, corporate finance etc.
- Conducted training programs on investment management, commodity markets etc.
- Conducted skill development programmes in the area of Finance for Ministry of MSME, Govt. of India.
- Works closely with the Training and Education Department of Multi Commodity Exchange of India (MCX), Mumbai for organizing training programs and carrying out research.

Mr. Shrikant Koundinya

FCMA, CGMA.

- He is a Fellow Member of the “Chartered Institute of Management Accountants”,
- He has 25 years of diverse experience in finance and capital markets, especially in areas such as audit, research, ERP, MIS and corporate training.
- He is currently leads the Training & Education function at the Multi Commodity Exchange.

Dr. PURUSHOTTAM BUNG

- Dr. Purushottam Bung is an engineer with a rich experience of around 26 plus years in Academia and industry (domestic and international).
- He completed PGDM from Melbourne Business School, Australia, one of the top 10 B-schools in the world and MBA from Monash University, one of the top universities in the world. He has a rich entrepreneurial experience of around 10 plus years in the food processing industry. He is on the expert/advisory/editorial panel of many Institutions,

Universities, NGOs and journals. Dr. Bung has presented and published 26 research articles in national and international refereed journals and undertaken several consultancy assignments.

- Dr. Bung was conferred with “Enterprising Academic Leader of the year (South India)” as part of National Education Excellence Awards in 2018. He was conferred with “Distinguished Educator” award in 2013. In 2015 he was awarded as ‘Best Director of a B-school in Karnataka’ as part of education excellence awards – 2015. He is member of many Associations and Institutional bodies.
- He is elected as FELLOW of World Academy of Productivity Sciences at Beijing, China recently. He is also a research fellow of Institute of Productivity, UK. Dr. Bung is offering management consultancy services to local Businesses, Institutions and entrepreneurs as well. Very recently he has completed a HarvardX course in collaboration with Pearson Global and Ureka Education group, UK on ‘Future of Learning’ anchored by Prof. Richard Elmore, Professor and authority in Education and Learning from Harvard.

Annexure 4
Attendees list

Attendee Report

9/23/2020 10:47

Webinar ID	Actual Start Time	# Registered	Unique Viewers
925 4527 7963	9/1/2020 14:34	532	289

User Name (Original Name)	Email	Leave Time	Country/Region Name
Dr. M Ajoy Kumar	ajoy@sit.ac.in	9/1/2020 14:50	India
Dr. M Ajoy Kumar	ajoy@sit.ac.in	9/1/2020 17:12	India
Prof. Dileep	dileep.rvim@rvei.ed	9/1/2020 17:12	India
Prof. Dileep	dileep.rvim@rvei.ed	9/1/2020 14:49	India
Dr. Purushottam Bung	drbung.rvim@rvei.e	9/1/2020 17:12	India

User Name (Original Name)	First Name	Email	Phone
chinmayi	chinmayi	chinmayins123@gm	9945925061
Ch.Raghavi	Ch.Raghavi	raghavivarma7@gm	6304293259
Dr.Meera.B Meera	Dr.Meera.B	mmeerababu@gma	9916875501
Dr.Meera.B Meera	Dr.Meera.B	mmeerababu@gmail.com	
Dr.Meera.B Meera	Dr.Meera.B	mmeerababu@gmail.com	
Naveen	Naveen	knroyal1@gmail.cor	9916277620
N.Ganga	N.Ganga	ganganatarajan200	8525857948
Avinash Agarwal	Avinash	avinashagarwal2102	8553235282
Avinash Agarwal	Avinash	avinashagarwal210297@gmail.com	
Kavina	Kavina	Kavina.mb19@bitsa	9787001912
Mamatha Acharya	Mamatha	acharyamamatha9@	8549049680
Manjunath	Manjunath	manjunathcb4ever@	7411171860
Aman Hans	Aman	amanhans505@gma	9045344818
Vandana	Vandana	Singhvandana39@g	9547871969
Swati Swati	Swati	swatigoud456@gma	8660288928
Ratnavalli Bhagavatula	Ratnavalli	ratnavalli_bhagavat	8686641352
Tanveer	Tanveer	tanveerstat@gmail.	9596560866

Annexure 5
Photo Gallery

**Continuing Education Programme on
Commodity Derivatives**

Organised by: RVIM, Bengaluru
Resource Person: Dr. M Ajoy Kumar
Day 1
01-09-2020

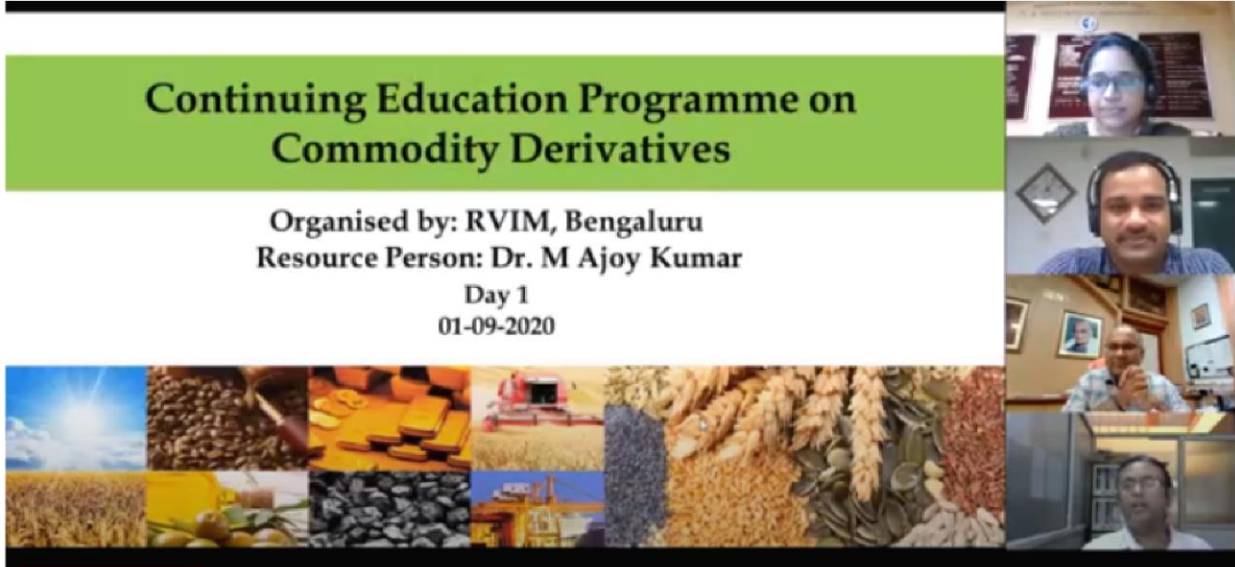

The image shows a presentation slide for a continuing education program. The title is 'Continuing Education Programme on Commodity Derivatives'. It is organized by RVIM, Bengaluru, with Dr. M Ajoy Kumar as the resource person. The program is for Day 1, dated 01-09-2020. The slide features a collage of commodity images at the bottom, including wheat, oil, and metals. To the right of the slide is a video call interface showing four participants in a grid layout.

Commodities

Commodities – Meaning & Types

Agricultural Commodities



Precious Metals



Base Metals

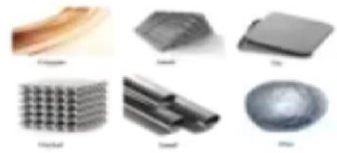

Energy Commodities



Live Stock



Commodity Trade

- Commodity trading is as old as human history
- Starting with the barter system, today it has become the backbone of global economy
- All manufacturing activities require basic raw materials and energy, which explains the significance of commodities
- The largest traded commodity in the world is crude oil in terms of value (\$1.7 Trillion)
- The largest metal traded is gold in terms of value (\$0.17 Trillion) and iron in terms of volume

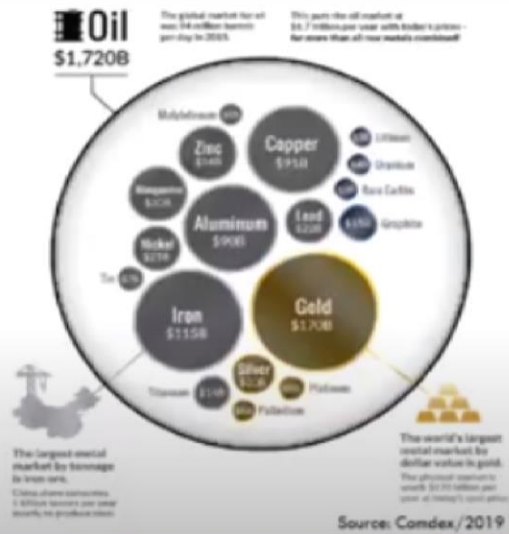

Global Commodity Market

- Commodity derivatives are the oldest form of derivatives, while financial derivatives emerged much later
- Earliest instances of commodity derivatives were found in rice trading in Japan; tulip bulb trading in Amsterdam etc.
- Dojima Rice Exchange in Osaka, Japan established in 17th century, was the world's first commodity exchange. More structured trading started with establishment of Chicago Board of Trade (CBOT) in 1848.



Coverage



- Trading on Commodity Exchange
- Exchange Risk Management tools
- Position limits
- Circuit Filters
- Clearing & Settlement- M2M & Margining
- Delivery

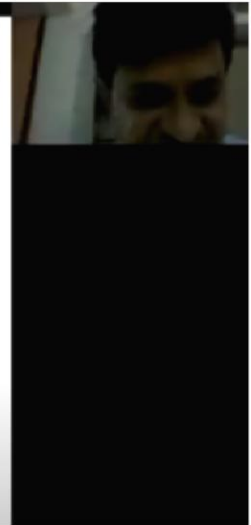

MCX Web Terminal for 11.8.10 (Powered By Thomson Engine)

View Market Tools Windows Help

UTCOM 11.08.2020 10:58:00

Symbol	US Asset	Symbol	Series/Exp.	S	C	Price	Q	T	Tr.	Buy Qty	Buy Price	Sell Price	Sell Qty	Last Update Time	Last Traded Time	LTP	
JTCOM	COPPER	COPPER	30SEP2020	A	1	REGS	INR	2500	REGS	517.85	517.90	514.70	2500	REGS	03:22:43 PM 04/09/2020	03:22:43 PM 04/09/2020	514.70
JTCOM	COPPER	COPPER	30OCT2020	A	1	REGS	INR	2500	REGS	514.35	514.70	514.70	5000	REGS	03:22:39 PM 04/09/2020	03:21:15 PM 04/09/2020	514.70
JTCOM	COPPER	COPPER	27NOV2020	A	1	REGS	INR	2500	REGS						12:53:47 PM 04/09/2020		
JTCOM	CRUDE OIL	CRUDEOIL	21SEP2020	A	1	BBL	INR	12000	BBL	3052.00	3053.00	3053.00	6000	BBL	03:22:45 PM 04/09/2020	03:22:45 PM 04/09/2020	3053.00
JTCOM	CRUDE OIL	CRUDEOIL	19OCT2020	A	1	BBL	INR	1100	BBL	3089.00	3092.00	3092.00	300	BBL	03:22:42 PM 04/09/2020	03:10:30 PM 04/09/2020	3092.00
JTCOM	CRUDE OIL	CRUDEOIL	19NOV2020	A	1	BBL	INR								10:18:21 AM 04/09/2020		
JTCOM	GOLD	GOLD	05OCT2020	A	10	GRAMS	INR	1	GRAMS	50860.00	50875.00	50872.00	2	GRAMS	03:22:44 PM 04/09/2020	03:22:11 PM 04/09/2020	50872.00
JTCOM	GOLD	GOLD	04DEC2020	A	10	GRAMS	INR	2	GRAMS	51082.00	51122.00	51122.00	1	GRAMS	03:22:44 PM 04/09/2020	03:02:24 PM 04/09/2020	51078.00
JTCOM	GOLD	GOLD	05FEB2021	A	10	GRAMS	INR	1	GRAMS	51207.00	51423.00	51423.00	1	GRAMS	03:22:41 PM 04/09/2020		
JTCOM	COTTON	COTTON	30OCT2020	A	1	BALES	INR	25	BALES	17520.00	17540.00	17540.00	25	BALES	03:22:22 PM 04/09/2020	03:11:25 PM 04/09/2020	17540.00
JTCOM	COTTON	COTTON	31DEC2020	A	1	BALES	INR	25	BALES	17210.00	17610.00	17610.00	25	BALES	03:15:11 PM 04/09/2020		
JTCOM	COTTON	COTTON	27NOV2020	A	1	BALES	INR	25	BALES	17390.00	17540.00	17540.00	50	BALES	03:22:17 PM 04/09/2020	03:15:11 PM 04/09/2020	17390.00
JTCOM	LEAD	LEAD	30SEP2020	A	1	REGS	INR	10	MT	152.70	152.80	152.80	20	MT	03:22:43 PM 04/09/2020	03:22:43 PM 04/09/2020	152.80

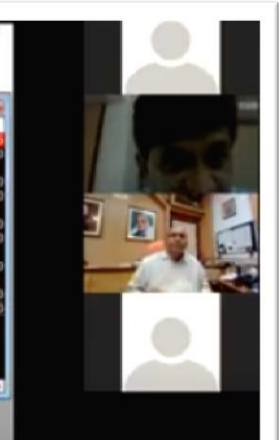

MESSAGE TO MEMBERS/PARTICIPANTS



- Launching of Commodities and Contracts
- Spot prices (domestic)
- Due Date Rates
- Imposition / withdrawals of margins
- Relaxation in Price Circuit Filter
- Reminders about contract expiry
- Any changes in the policy of Exchange

SESSION NAME	SOYA	SYMBOL	MIN VALUE	MAX VALUE
SESSION TYPE	Even	SB2KAS	123.50	136.50
START TIME	09:00:00	SB3CHI	128.25	141.75
END TIME	09:15:00	SB2MPO	128.25	141.75
		SB2CHI	133.89	141.88
COUNT DOWN	15 MINS	SB3KAS	123.50	136.50



Annexure 6
Detail Feedback (if required)

Name of the Participant	Your suggestions for improving future Programmes
Dr. S. Durga	Everything is good
Dr. Bhoga Suvarchala Munduru	nice session
Supraja Anupindi	The programme was extremely excellent.
Gururaj Patil	please increase the number of contact hours
Ajithukumar	very good learnings from this event, Thank you RVIM
Usha Sadhani	Please let us know about further session s
Priya Rani Arun Kumar	Amazing program insist for more such webinars on Derivatives
MOHAMMED SOUBAN S	It was indeed and great session thanku
AISHWHRYA R	Overall it is excellent
Dr. Meenakshi Shrirang Wagh	It was a wonderful session explained so lucidly. Please organise many more such programmes and especially on financial derivatives
POOJA M	Thank you for such a wonderful program..
Madhu Bangarimath	Arrange some other programs it will help us to gain knowledge thank you for giving an wonderful opportunity to us.
Meganathan D	Very informative thanks
MUKTI NILAY SHAH	Give us more opportunity in all the upcoming program.
Shubham Chugh	All 4 days were a new information to learn... wanted to be in touch with RVIM for further wonderful and successful sessions. Thanks
Pavithra J	Its is really good and informative!!! Thank you RVIM !!!
Dr. Kiran J. Patel	If possible, extend such type FDP for 1 week with evening time. Thank you.
V.vinodhini	Yes it was a interesting session for 4 days.Expecting more webinars on finance domain.
Dr. Aruna Gudimetla	All 4 days session was informative. Excellent
Rashmi Gowda KM	Very well planned and everthing was taken care off! Looking forward for more such workshops regarding finance (like crypto- currency as we have very limited knowledge of such topics)
SWATI	It was an informative session , I learnt a lot from this sessions. Do keep this sessions further also .
Kumrephi kharei	Overall the programe is excellent ☐ looking forward to join the session again,thank you ☐
KAJAL R TIWARI	bring session on finance topic related to current scenario

Chandrashekhar Ramesh Gajbhiye	Wonderful and fantastic session I learned so many things from the sessions. The way of delivering the speaker was very awesome. I really appreciate it
Pavithra J	Really informative and good !!! Thank you RVIM !!!
Dr. BASAVARAJU P S	We are learning form RVIM to conduct effective and efficient way of running the program. Nothing to suggest. Thank you very much for a wonderful program
Dr. SHALINI R	Very well organized program. Would like to attend many more such programs.
DINESH KUMAR A	no suggestions, keep up the good work team RVIM
Mrs. M. GIRI KUMARI	You organized very well, hope to continue in future
Medapati pavani	No improvements required. The webinar is perfectly awesome
Ramesha	Thanks to RVIM for organize well sessions on 4 days about CEP program and to give the permission to audience to asking question in face to face. Thank you once again
Dr Meena Sharma	So many things were covered in a very short time span. Some more time needed to understand things more clearly.
SIMRAN	It was an amazing knowledge shared by the resource persons & had wonderful experience in this sessions.
Dr. Sarita Agrawal	Everything was very well organized. Keep it up
Dr. Gopika G. G.	Well and sincerely organised one right from prayer song up to National Anthem. Thank you so much for the organisers.
Ranjitha L	No suggestions to improve and it's a great programme thank you RVIM
Aishwarya Deokar	Excellent knowledge provided with examples which eventually has added a lot of value. Keep doing such wonderful programs!!!
Jainabbanu khalifa	Continue taking this types of web. Helping to others for their understanding
Vinutha MT	Informative session
Shubham Chugh	All 4 days were a new information to learn... wanted to be in touch with RVIM for further wonderful and successful sessions. Thanks
Prof Santhosh Rebello	Very good ..new knowledge for.me ..thanks a lot
Smitha G Roopesh	It was completely excellent, so no need to suggest anything.
Rency Joseph	Please provide it to our students



CEP on BIG DATA ANALYTICS	
Date: 5 th October to 10 th October 2020	Venue: Zoom webinar
Time: 11 am to 1 pm	Event : Webinar
No. of Participant: 101	Event Coordinator: Dr. Santhosh M Prof. Reddy Prof Dileep Prof. Priya Jain
Objectives <ul style="list-style-type: none">- To gain deeper understanding of the concept of Big Data Analytics.- To learn how data analysis can be done using Hadoop.- To understand the concept of HDFS, MapReduce, Yarn and Hive.- To analyze the different tools available for data analysis like Python, Git Hub, PySpark, Jupyter etc.- To understand the concept of Image analytics, sentiment analytics and fraud analytics.- To learn how big data analytics takes place in different industries.	
Agenda/Flow of the Event <ul style="list-style-type: none">• 5th October: Introduction to Big Data Analytics• 6th October: Hadoop concepts and Architecture• 7th October: Exploring Big Data and communicating insights• 8th October: Big Data analytics life cycle• 9th October: Big Data analytics life cycle (concept of sampling data and used cases)• 10th October: Big Data analytics in industry and panel discussion	
Outcome Achieved/ Attained: <ul style="list-style-type: none">- Dr. Purushottam Bung on the first day set the context of the program by explaining about the evolution of big data analytics. He explained about the 5 Vs of big data analytics.- Then session I was started by Mr. Sai Bharath. He introduced the concept of data science and big data analytics to the audience. He laid the foundation for big data analytics and explained how big data is driving digital transformation. Then the session was taken over by Mr. Srujan and he	

explained about the big data in marketing and retail. He told about what is next best action for customers in real time.

- On the second day Mr. Sai explained in detail about the clusters in Hadoop. He explained various terminologies like Rack, Course and Hadoop architecture. He also told about the concept of HDFS, MapReduce, Yarn and Hive.
- On third day Mr. Sai Bharath took the practical example of Hadoop and explained how Hadoop can be used for data analysis. On the same day Mr. Debayan Roy also explained the concept of data insight communication using a industry used case.
- On fourth day Ms Divya introduced various other tools like Jupyter, Python, GitHub and PySpark to the audience. She explained how these tools can also be used for analyzing data. Further the session was taken over by Mr. Shreyans and he explained about the concept of image analytics.
- On fifth day the Ms. Divya explained briefly about the concept of sampling as it is very important in data analysis. Later on Mr. Srujan explained the concept of fraud analytics.
- On the last day Mr. Divya explained about the structured and unstructured data available with the help of used case. Later on Mr. Jishnu explained about the concept of sentiment analysis.
- At the end panel discussion was held where in all the speakers explained about how data analysis is happening in various sectors like financial sectors, health sector, fitness sector etc. All the speakers also shared their career journey which motivated all the participants.

Feedback & Coordinator Comment:

The entire program was very well received by all the participants. All the participants appreciated the program and were happy to have deeper knowledge on various concepts related to big data analytics. During the sessions participants had a chance to know how various new tools like Hadoop, python, jupyter, spyder, pyspark etc works. Everyone appreciated the program and motivated the organizers for many such programs in the future.

Event Coordinators

Dr. Santhosh M

Prof. Nagasubba Reddy

Prof. Dileep

Prof. Priya Jain



Director

Dr. Purushottam Bung





RV Institute of Management[®]

Affiliated to Bengaluru Central University

Approved by AICTE, New Delhi. Accredited by NAAC with 'A+' grade.

Go, change the world



Rashtriya Sikshana Samithi Trust

R V Institute of Management

CA 17, 36th Cross, 26th Main, 4th T Block, Jayanagar, Bangalore – 560 041

Ph: 080-26547048 Fax: 26654920 ; URL: rvim.edu.in ; Email: contact.rvim@rvei.edu.in



is Organising

**ONE WEEK
CONTINUING EDUCATION PROGRAM
ON
BIG DATA ANALYTICS**

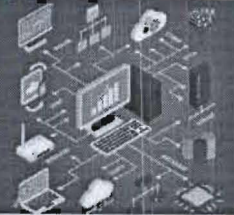

Date : 5th October 2020 to 10th October 2020 Time : 11 am to 1 pm

KEY SPEAKERS



Mr. SrujanDarsi
Lead Consultant,
Data Science consulting, Infosys



Mr. Jishnu Mukherjee
Senior analyst, Infosys



Mr. Debayan Roy
Senior Analyst, Barclays



Mr. Sai Bharath
Senior Software Engineer,
R&D Analytics, Tredence Inc



Ms. Divya Choudhary
Senior Data Scientist,
Siemens



Mr. Shreyans Sharma
Assistant Manager
Analytics and Insights, Titan.

Moderator



Dr. Purushottam Bung
Professor & Director – RVIM

Registration Link: <https://forms.gle/iafEqFmTU1CcW719>

Payment Details

- Rs 500 for Faculty Members / Industry persons/ Research Scholars
- Rs 200 for students

If Bank Transfer

Name Director RV Institute of Management
Bank Name ICICI Bank, 9th Block Branch
A/C No. 029901002291
IFSC Code ICIC0000299
MICR Code 560229022

**For Google Pay/ Phone Pay/
BHIM UPI Transfer**



FACULTY COORDINATORS

Dr. Santhosh M 9739945333 Prof. Dileep S 8553276869
Prof. Nagasubba Reddy 9845492336 Prof. Priya Jain 9108300728

businessanalyst.fdp2020@gmail.com



RV Institute of Management®

Affiliated to Bangalore Central University.

Approved by AICTE, New Delhi; Accredited by NAAC with 'A+' grade.



Go, change the world



Rashtreeya Sikshana Samithi Trust

R V Institute of Management

CA 17, 36th Cross, 26th Main, 4th 'T' Block, Jayanagar, Bangalore – 560 041

Ph: 080-26547048 Fax: 26654920; URL: rvim.edu.in; Email: contact.rvim@rvei.edu.in

is Organising

“BIG DATA ANALYTICS”

Date : 5th October 2020 to 10th October 2020

Date	Session Title	Key speakers	Timings
5 th October, Monday	Introduction to Big data analytics	Mr. Sai Bharath & Mr. SrujanDarsi	11:00 am to 1:00 pm
6 th October, Tuesday	Hadoop concepts and Architecture	Mr Sai Bharath	11:00 am to 1:00 pm
7 th October, Wednesday	Exploring Big data and communicating insights	Mr. Debayan Roy & Mr Sai Bharath	11:00 am to 1:00 pm
8 th October, Thursday	Big data analytics Life cycle (Tools used in analytics - Jupyter, GIT, Python and Pyspark)	Mr. Shreyans Sharma & Ms Divya Choudhary	11:00 am to 1:00 pm
9 th October, Friday	Big data analytics Life cycle (Concept of Sampling data, Use case)	Ms. Divya Choudhary & Mr. SrujanDarsi	11:00 am to 1:00 pm
10 th October, Saturday	Big data analytics in Industries	Mr. Jishnu Mukherjee & Ms. Divya Choudhary	11:00 am to 1:00 pm
	Lunch break		1:00 pm to 2:00 pm
	Big data analytics Way forward	Panelist discussion by all the key speakers	2:00 pm to 4:00 pm

LIST OF PARTICIPANTS OF CEP ON BIG DATA ANALYTICS

Date: 5th October to 10th October

S.no	Email ID	Name	Designation	Institute	Phone Number	Amount Paid
1	shahapurkar.shreya123@gmail.com	Shreya Shahapurkar	Student	R V institute of Management Bangalore	918867145075	Rs 100
2	darshang8892@gmail.com	Darshan G	Student	RVIM	7892744873	Rs 100
3	archanaanitha1@gmail.com	ARCHANA V	Student	R V Institute of Management	7204619153	Rs 100
4	bindupriyasmdc@gmail.com	Bindu Priya	Student	R V Institute Of Management	8123337714	Rs 100
5	bharathdvmurthy21@gmail.com	Bharath Kiran D V	MBA student	R V Institute of Management	7676423766	Rs 100
6	lathashree31@gmail.com	Lathashree S	Student	R V INSTITUTE OF MANAGEMENT	9741354577	Rs 100
7	tanzeelahmed395@gmail.com	Tanzeel Ahmed	Student	Rv institute of management Bangalore	9041652535	Rs 100
8	maheshas2694@gmail.com	Mahesha. S	Student	RV INSTITUTE OF MANAGEMENT	8861573232	Rs 100
9	amarnathpujarim@gmail.com	Amarnath P M	Student	Rv Institute of Manegement	918499957729	Rs 100
10	p.n.balajivasavi@gmail.com	B Vasavi	Student	RV institute of management	8904517892	Rs 100
11	sravanthitatineni04@gmail.com	Sravanthi T	Student	RV INSTITUTE OF MANAGEMENT	9632889669	Rs 100
12	chiraagm98@gmail.com	chiraag mallikarjun	Student	Rv Institute of Management	7349734948	Rs 100
13	vidyavenut@gmail.com	Vidya V T	Student	RV INSTITUTE OF MANAGEMENT	8494915915	Rs 100
14	sushmitharamanath@gmail.com	Sushmitha D.R	Student	RV institute of management	9740109400	Rs 100
15	udayravi9urk@gmail.com	UdayaRaviKanth KV	MBA	RV Institute of Management	0	Rs 100

16	abhaypai2919@gmail.com	ABHAY PAI	STUDENT	RV INSTITUTE OF MANAGEMENT, BANGALORE	7483898039	Rs 100
17	chandhangowda.s@gmail.com	Chandhan S	Student	RV INSTITUTE OF MANAGEMENT	8073836728	Rs 100
18	viveka.696a@gmail.com	Viveka R	3rd semester student	Rvim	9620386669	Rs 100
19	shrihari1411@gmail.com	Shrihari V		R V Institute of Management	9741534648	Rs 100
20	kambhamharshitha81@gmail.com	Kambham Harshitha	Student	R V Institute of Management	8639161263	Rs 100
21	arunbhat.bhat@gmail.com	Arun Raveendra Bhat	Student	R V Institute of Management	8277612604	Rs 100
22	tejashreebhat0027@gmail.com	Tejashree bhat	MBA	R V institute of management, Bangalore	9482186292	Rs 100
23	shubham29398@gmail.com	Shubham Basavaraj Beesanakoppa			9482551864	Rs 100
24	bganapati6@gmail.com	Ganapati Janardhan Bhat	Student	R V Institute of Management	8150906458	Rs 100
25	4090krishna12@gmail.com	Rashmi	Student	Rvim Bangalore	8105963102	Rs 100
26	sagardesai4118@gmail.com	Sagar M. Desai	Student	RV Institute of Management, Bangalore	9972995904	Rs 100
27	bharath.mr26@gmail.com	Bharath Gowda M R	Student	R V Institute of Management	8553217632	Rs 100
28	tejashwini.shivu29@gmail.com	Tejashwini S	MBA	RV Institute of Management	9945727583	Rs 100
29	priyankamurthyv29@gmail.com	Priyanka V Murthy	Student	RV Institute of Management	9591779785	Rs 100
30	krishnaprasadk14@gmail.com	K Krishnaprasad	MBA	RV Institute of Management	9980142634	Rs 100
31	pranav007hpt@gmail.com	Pranav Pramod Kumar	Student	R V INSTITUTE OF MANAGEMENT	9740412804	Rs 100
32	shashikiranbuddy@gmail.com	Shashi kiran	Student	Rv Institute Of Management	919632808787	Rs 100
33	poornimapatil916@gmail.com	Poornima	Student	RV Institute of Management, Bengaluru	8971575309	Rs 100
34	nbgowtami.naik18@gmail.com	N B Gowtami	Student	RV Institute of Management	8861821518	Rs 100

35	akshay8277@gmail.com	Akshay kumar	Student	RV INSTITUTE OF MANAGEMENT	8660639327	Rs 100
36	rakshithbhat987@gmail.com	RAKSHITH P S	MBA	R V INSTITUTE OF MANAGEMENT BANGALORE	9611293249	Rs 100
37	preetibthite@gmail.com	Leelavati B Thite	Student-RVIM	RV Institute of Management	7204334809	Rs 100
38	smeetapatil07@gmail.com	Smeeta Patil	Student	R V Institute of management, Bengaluru	7259816967	Rs 100
39	tahsinhadalge98@gmail.com	Tahsin Hadalge	Student	RV institute of management	7204739139	Rs 100
40	amoghnimbargi@gmail.com	Amogh N	Student	RV Institute of management	919449281604	Rs 100
41	sandeshbhatsmp@gmail.com	Sandesh Bhat	Student	RVIM	9008811647	Rs 100
42	darshant8762@gmail.com	Darshan Toolahalli	MBA	RV Institute of Management	8762708874	Rs 100
43	deenakrishna97@gmail.com	Deena k	Student	RV institute of Management	9844245971	Rs 100
44	pashasif30@gmail.com	Syed Asif Pasha	Student	R V Institute Of Management	7019048592	Rs 100
45	abhisheklakkundi@gmail.com	Abhishek VL	Student	R V Institute of management	8867919357	Rs 100
46	lingrajpatil999@gmail.com	lingraj Patil	Student	RV	7892638350	Rs 100
47	chaitrahiregowdara@gmail.com	Chaitra Hiregowdara	Student	RV Institute of Management	9148468600	Rs 100
48	sushbhat101098@gmail.com	Sushma Bhat K	Student	RV Institute Of Management	7795043804	Rs 100
49	abhi100joshi@gmail.com	Abhishek Jagadish Joshi	Student	R V Institute of Management	9742368988	Rs 100
50	poojampatil36@gmail.com	Pooja mallappa patil	Student	Rv Institute of management banglore	9663012603	Rs 100
51	trivenicherukuri1@gmail.com	cherukuri triveni	student	Rvim	8431600479	Rs 100
52	salu2230@gmail.com	Salman pasha	Student	RVIM	8618774474	Rs 100
53	deekshak1198@gmail.com	Deeksha K	Student	RV Institute of Management	9731549911	Rs 100
54	supchatni@gmail.com	Suprita S Chatni	Student	R V Institute Of Management	6362759914	Rs 100
55	timmareddy834@gmail.com	Timmareddy	Student	RV Institute Of Management Bangalore	8746006146	Rs 100

56	suganravi36@gmail.com	Sugan G R	Student	R v Institute of management	8610835688	Rs 100
57	muzz007shaik@gmail.com	Muzammil Rihan	Student	RV INSTITUTE OF MANAGEMENT	8073626891	Rs 100
58	harshandas7@gmail.com	Harsha Nagaraj Das	Marketing and Business Analysis	RVIM	9972599305	Rs 100
59	divyamugadur@gmail.com	Divya Mugadur	Student	RVIM	9845972114	Rs 100
60	chetanvijay98@gmail.com	Chetan Vijay	Marketing & BA	RVIM	8884067776	Rs 100
61	gowthamsm444@gmail.com	Gowtham S M	Student	R V Institute of Management	9482444773	Rs 100
62	meghanartgowda8@gmail.com	Meghana R T	Student	RVIM	7353995851	Rs 100
63	infocvs4@gmail.com	Jitendra CVS	Student	PBSC	7337349735	Rs 200
64	mridulkarnika2212@gmail.com	Karnika Mridul	Master of Business Administration		7903639237	Rs 200
65	preethamhn.n20@gmail.com	Preetham H N	To learn about big data	Seshadripurum college bangalore	7349377259	Rs 200
66	shriji.patil@gmail.com	Shriraksha S Patil	Student	Rotary School Navanagar Hubli	9900409419	Rs 200
67	sukhamromen@yahoo.co.in	Sukham Romen Singh	MCA Student	NG College	7005358708	Rs 200
68	nehahr.arora@gmail.com	Pranshik Arora	Student	Fore School of Management	7428228692	Rs 200
69	sushmakamath16@gmail.com	Sushma Kamath	Student	RV Institute of Management	7353180581	Rs 200
70	srinidhibk58@gmail.com	Srinidhi BK	Student	RV Institute of Management	9900816573	Rs 200
71	sahanagaonkar1997@gmail.com	Sahana S Gaonkar	Student	Rv institute of management	9483132313	Rs 200
72	kkirthan@gmail.com	Kirthan	Student	RV Institute Of Management	8861586373	Rs 200
73	prinsondlima123@gmail.com	Prinson Dlima	Student	RV Institute of Management	7406984706	Rs 200
74	drinyachandrank@gmail.com	Drinya K Chandran	MBA	RVIM	919739175649	Rs 200
75	rachanahgowda1998@gmail.com	Rachana H Gowda	Student	RV institute of management	8317371816	Rs 200
76	sujatha.99601@gmail.com	D.Sujatha	Student	Sri Muthukumaran Institute of Technology	8825615240	Rs 200

77	seeeromai@gmail.com	RAMALINGAPPA B S	Student	Seshadripuram College	9739113877	Rs 200
78	shivukumarshivu151@gmail.com	Shivu kumar k	Student	Sheshadripuram main college	8549095047	Rs 200
79	naveen.pol2007@gmail.com	Dr. Naveen Pol	Assistant Professor	Acharya Bangalore B-School	9739905518	Rs 500
80	vivekanands@rvce.edu.in	Vivekanand S Gogi	Assistant Professor	RV College of Engineering	9449624424	Rs 500
81	jhakundan051@gmail.com	Kundan Kumar Jha	Research Scholar	PRIST Deemed to be UNIVERSITY, Thanjavur	7094899109	Rs 500
82	reshmabhaskar26@gmail.com	Reshma.B	Asst.Professor	SJR college of Science, Arts and Commerce	7204024491	Rs 500
83	niharika1996shivu@gmail.com	Niharika S	Assistant professor	SJR College	9535723430	Rs 500
84	saiyashu23@gmail.com	Yashaswini.S	Assistant professor	SJR College of Science, Arts and Commerce	8095794281	Rs 500
85	principal@dsba.edu.in	Dr(Brig)Sandes	Principal	Dayananda Sagar Business Academy	9980922121	Rs 500
86	hod@dsba.edu.in	Nikitha Sreekantha	HOD - DSBA	Dayananda Sagar Business Academy	9886434746	Rs 500
87	kssubashmails@gmail.com	K S Subash	Asst. Professor	Brindavan College	9740488557	Rs 500
88	meera.seshanna@gmail.com	Meera	assistant professor	dayananda sagar business academy	9945713353	Rs 500
89	radhi3sree@yahoo.co.in	Dr.P.V.Radhika	Assistant Professor	GDC Pamarru	9849449735	Rs 500
90	digneshpanchasara@gmail.com	Dignesh Shaileshbhai Panchasara	Assistant Professor	Rai University	7874122777	Rs 500
91	surjit.mei@gmail.com	Khumanthem Surjit Meetei	Faculty	Delta Advance School	918787349101	Rs 500
92	brmn47gsch@gmail.com	Basavaraju MN	Principal	SJR College of Science, Arts and Commerce	9481953596	Rs 500
93	sumangalatalur@yahoo.com	Sumangala Talur	Associate professor	Adarsh Institute Of management and information technology	9740119585	Rs 500
94	guruduttshenoy@gmail.com	Gurudutt Shenoy	Adjunct faculty	RVIM	9591722825	Rs 500

95	crgopesh@gmail.com	Dr. C.R. Gopesh	Operations Manager	Aakash Group	9995432198	Rs 500
96	urdangarwala@gmail.com	Dr. Umesh R. Dangarwala	Associate Professor	The Maharaja Sayajirao University of Baroda	9824019199	Rs 500
97	profkhaja@gmail.com	KHAJA MOHINUDEEN J	Lecturer	Smt. Allum Sumangamma Memorial College for Women, Ballari	9449717652	Rs 500
98	sanjay.n16@gmail.com	Sanjay Nagtode	Research Fellow	NITIE Mumbai	9833220792	Rs 500
99	Divyateja2007@gmail.com	Divya Teja	Research Scholar	Osmania University	9550368730	Rs 500
100	rrgondkar@gmail.com	DR RAJU R GONDKAR	PROFESSOR	SAINT GEORGE COLLEGE	9341101680	Rs 500
101	chandrika14krishnan@yahoo.in	CHANDRIKA KRISHNAN		BNM INTSTITUTE OF TECHNNOLOGY	9632684691	Rs 500
TOTAL AMOUNT						Rs 20900

Annexure 5

Photo Gallery

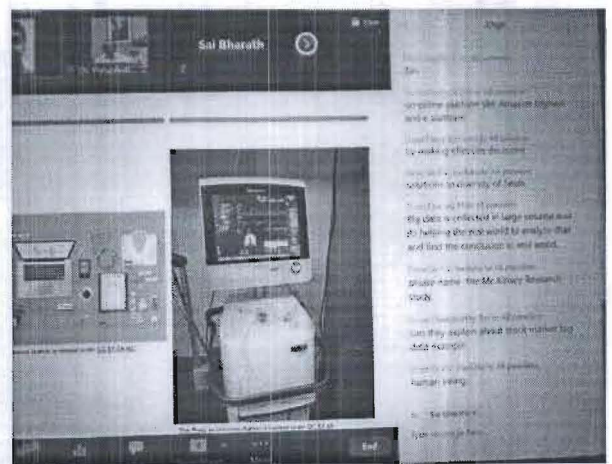
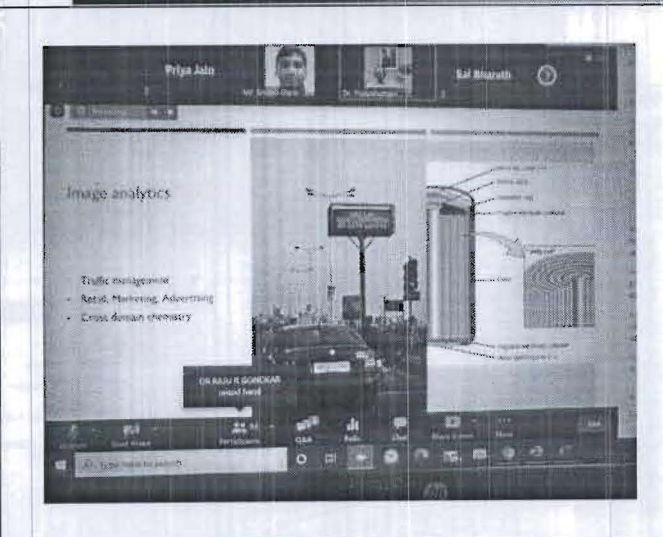
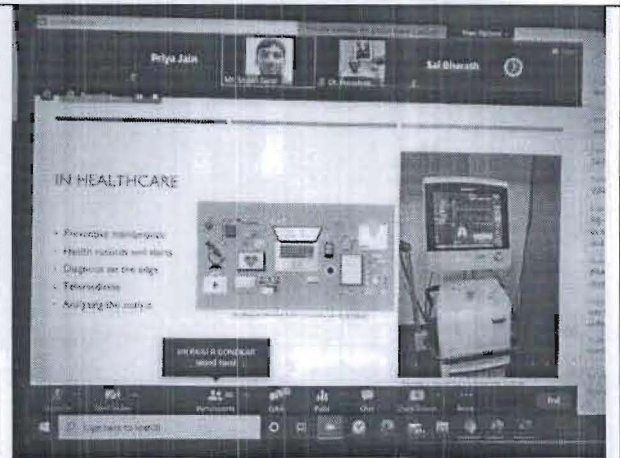
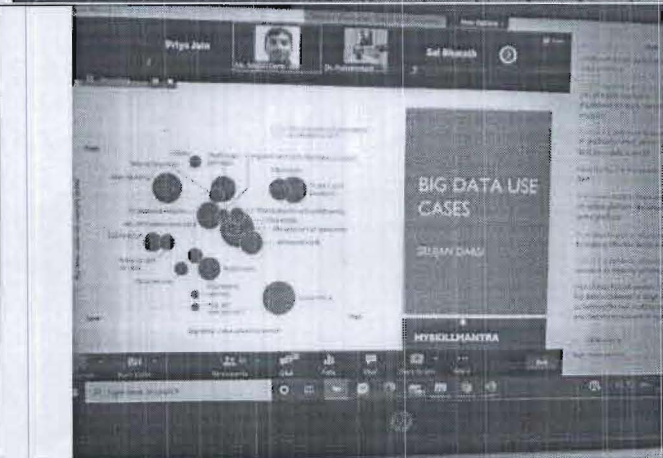
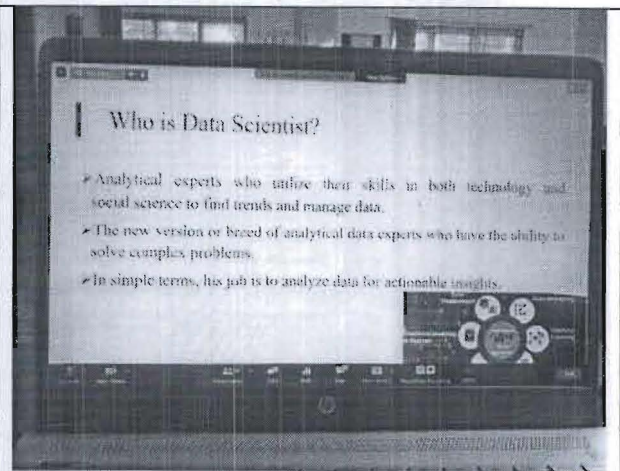
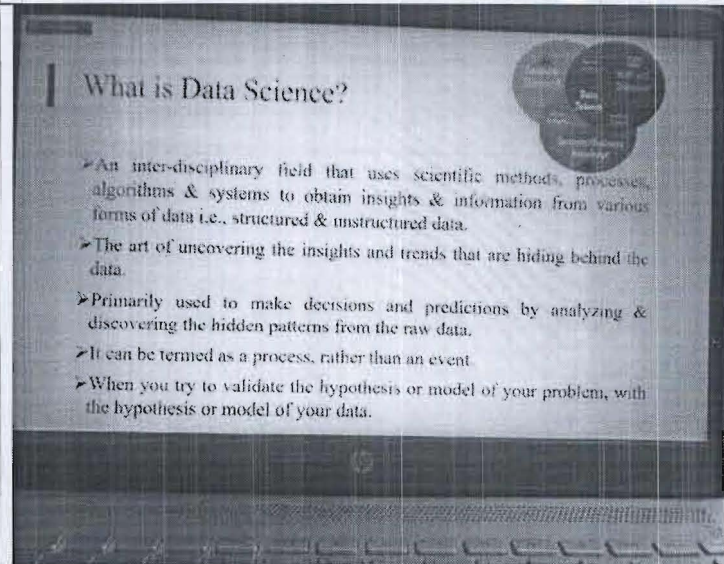

Priya Jain Prof. Nagarath Sai Bharath Prof. Dhanraj

Hadoop Architecture

```

    graph TD
      subgraph Master_Node [Master Node]
        NameNode
        SecondaryNameNode
      end
      subgraph Slave_Nodes [Slave Nodes]
        subgraph Slave_Node_1 [Slave Node]
          DataNode
          MapReduce
        end
        subgraph Slave_Node_2 [Slave Node]
          DataNode
          MapReduce
        end
        subgraph Slave_Node_3 [Slave Node]
          DataNode
          MapReduce
        end
      end
      Master_Node --- Slave_Nodes
  
```

Priya Jain Prof. Nagarath Sai Bharath Dr. Santhosh M

What is Hadoop?

- ✓ An open source framework that is used to efficiently store & process large datasets ranging in size from gigabytes to petabytes of data.
- ✓ A framework that allows you to store data Big Data in a distributed environment, such that you can process it parallelly.
- ✓ A collection of open source software utilities that facilitate using a clustered network of multiple computers to analyze & process massive datasets in parallel more quickly.
- ✓ The term Hadoop is often used for both hardware evolution and software evolution.

Priya Jain Dr. Santhosh M Sai Bharath

Priya Jain Prof. Nagarath Sai Bharath

Concepts of Hadoop

- ✓ HDFS
- ✓ Map Reduce
- ✓ Yarn
- ✓ Hive

Simple Random Sampling

Example

Every member of the population has an equal chance of being selected.

Qn: How happy are you with your decision to join the college?

You want to select a simple random sample of 100 students of College X.

You assign a number to every student in the database from 1 to 1000, and use a random number generator to select 100 numbers.

Bias?

No Bias

A/B Testing

HOW BIG IS ECOMMERCE FRAUD?

Annual online payment fraud losses from e-commerce, airline bookings, money transfer and banking services will reach \$48 billion by 2023 (from \$22 billion in 2018).

```

1 # Connect to the Hadoop cluster from the local machine
2 # Use the following code to connect to the Hadoop cluster
3 # Use the following code to connect to the Hadoop cluster
4 # Use the following code to connect to the Hadoop cluster
5 # Use the following code to connect to the Hadoop cluster
6 # Use the following code to connect to the Hadoop cluster
7 # Use the following code to connect to the Hadoop cluster
8 # Use the following code to connect to the Hadoop cluster
9 # Use the following code to connect to the Hadoop cluster
10 # Use the following code to connect to the Hadoop cluster
  
```

PySpark ML tutorial for beginners

```

1 import sys
2 import pandas as pd
3 import numpy as np
4 from sklearn.metrics import accuracy_score
5 from sklearn.metrics import precision_score
6 from sklearn.metrics import recall_score
7 from sklearn.metrics import f1_score
8 from sklearn.metrics import roc_auc_score
  
```

HOW BIG IS IMAGE ANALYTICS?

- 80% of the unstructured data that is generated in the form of images and objects
- Where is Image Data Generated?
 - Healthcare
 - Travel/Tourism
 - Social Media/ Smart phones
 - Autonomous Driving
 - Retail
 - Architecture
 - Product Design
 - Sports
 - Form Data (generated in Financial Institutions, Government Institutions etc.)
 - Scientific Applications (molecular biology, chemometrics etc.)

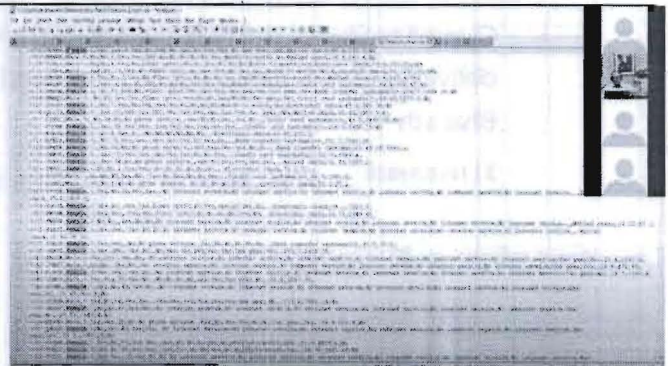

Annexure 6 Detail Feedback

Overall rating of the resource persons considering command on the subject matter and delivery : Day1 : Introduction to Big Data Analytics by Mr. SrujanDarsi and Mr.Sai Bharath

31 responses

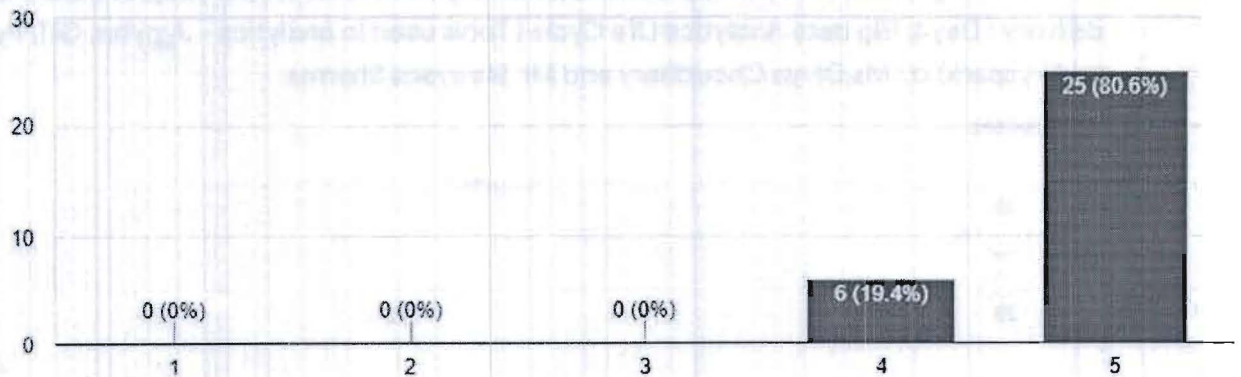

Overall rating of the resource person considering command on the subject matter and delivery : Day2 : Hadoop Concepts and Architecture by Mr.Sai Bharath

31 responses

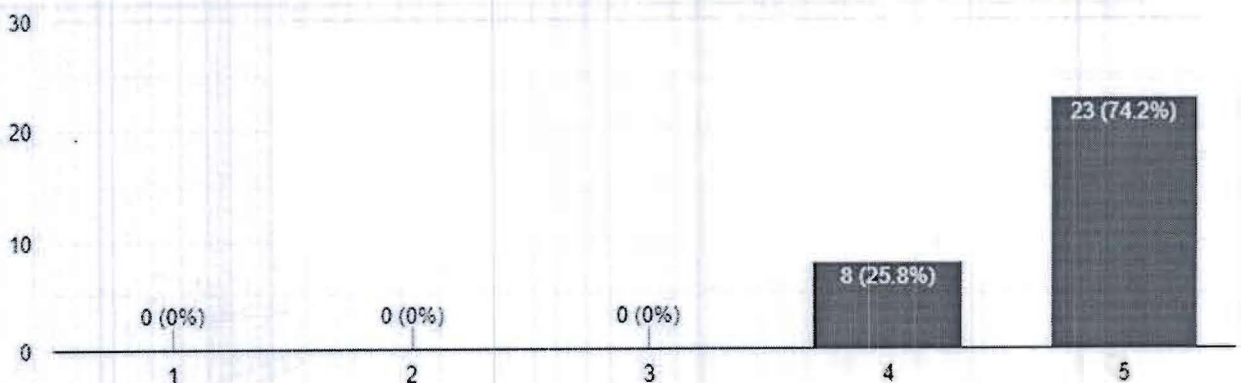

Overall rating of the resource persons considering command on the subject matter and delivery : Day3 : Exploring Big data and communicating insights Ms.Debayan Roy and Mr.Sai Bharath



31 responses

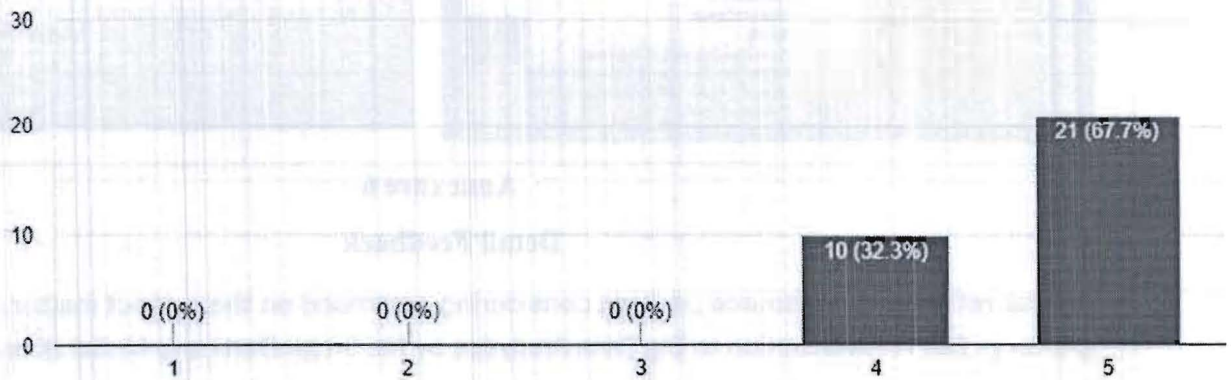

Overall rating of the resource persons considering command on the subject matter and delivery : Day4: Big data Analytics Life Cycle (Tools used in analytics - Jupyter, GIT, Python and Pyspark) by Ms.Divya Choudhary and Mr. Shreyans Sharma

31 responses

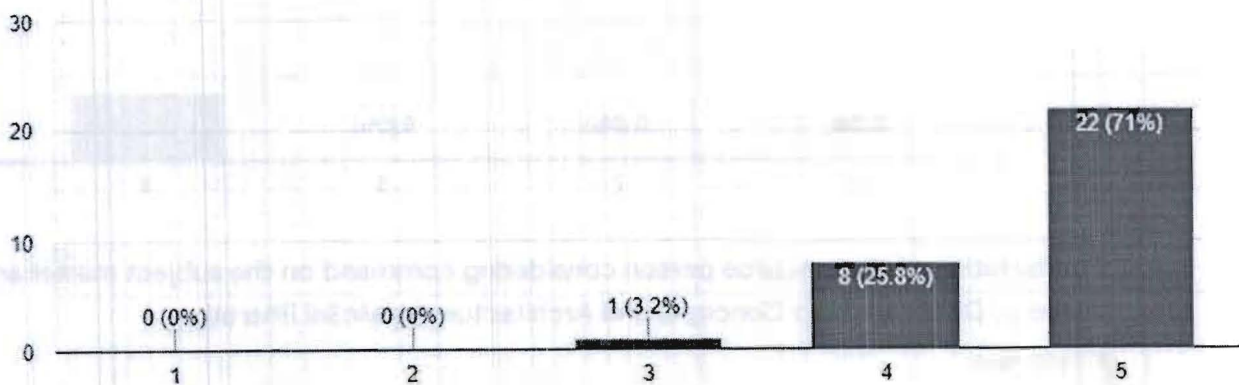

Overall rating of the resource persons considering command on the subject matter and delivery :Day5: Big data analytics Life Cycle(Concept of Sampling data,Use case by Ms.Divya Choudhary and Mr. SrujanDarsi



31 responses

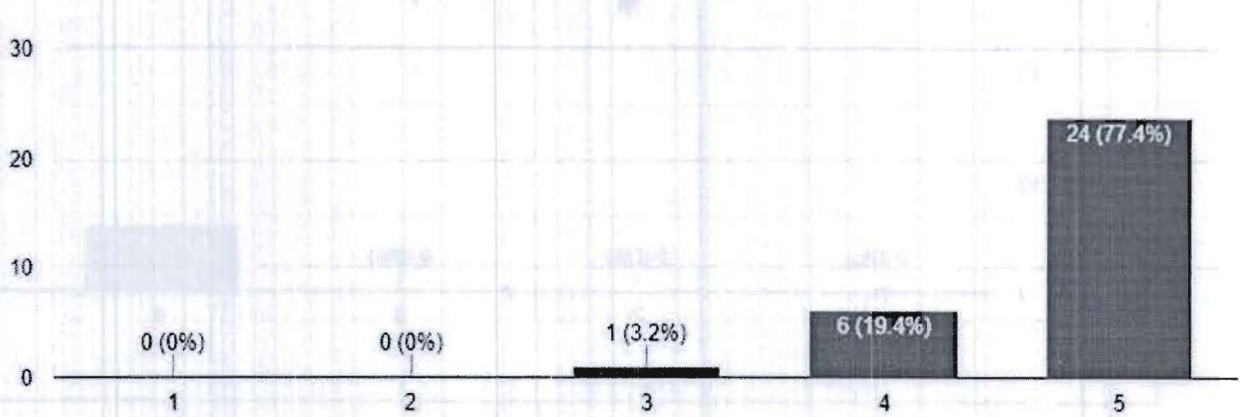

Overall rating of the resource persons considering command on the subject matter and delivery :Day6: Big data analytics in Industries by Ms.Divya Choudhary and Mr. Jishnu Mukherjee

31 responses

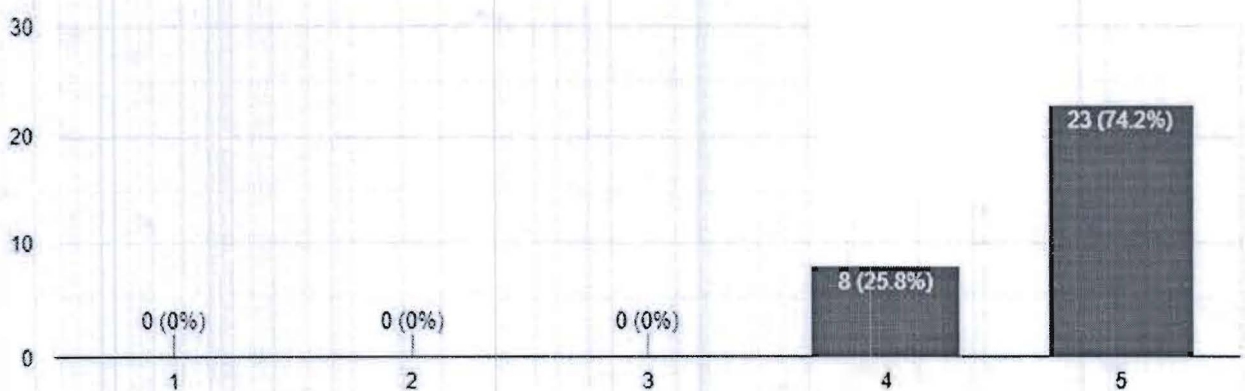

Overall rating on conduct of Continuing Education Program on : "Big Data Analytics"



31 responses

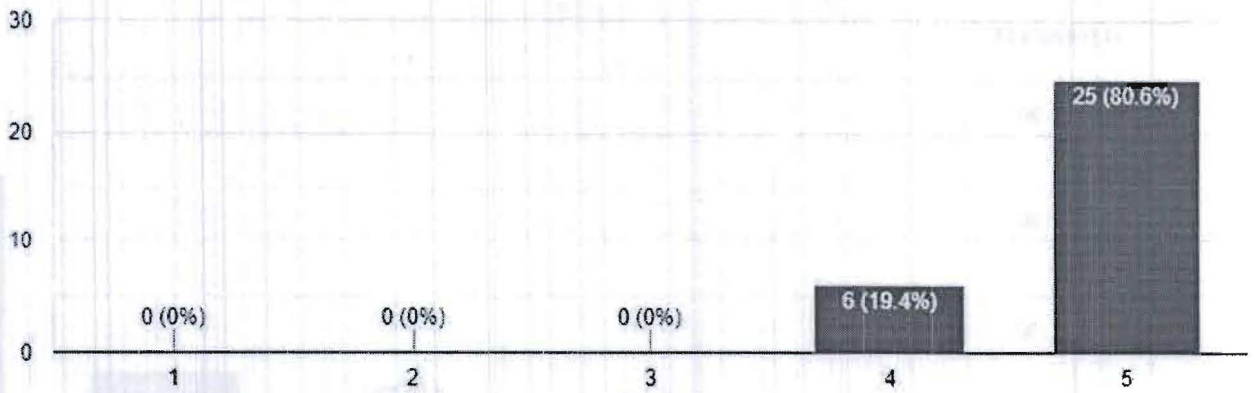

DETAILED AGENDA FOR THE CEP ON BIG DTA ANALYTICS

Date: 5th October to 10th October 2020

Time: 11 am to 1 pm

Date	Day Name	Module Name	Speaker/Trainer	Estimated Time (mins)
5 October	Day 1: Introduction to Big data analytics	Opening note on the webinar programme and importance of Big data analytics	RV team/Dr.Bung	10
		What is Data science? Who is a data scientist? Who is a big data scientist?	Sai Bharath	15
		Big data powered Data Science (5Vs etc)		15
		Illustration of speed/size in big data vs Traditional set-up		15
		Big data powered Data Science - Illustration	Srujan	15
		Overview of some Industry use cases - Data science with Big data in Marketing, Data Science with Big data in Finance/Ecommerce, Sentiment analysis		20
6 October	Day 2: Hadoop concepts and Architecture	Hadoop Architecture overview	Sai Bharath	5
		Storage systems in Big data vs SQL		15
		Map Reduce concept and Illustration		20
		Concepts and Working with HIVE		30
		Architecture - End to end		20
7 October	Day 3: Exploring Big data and communciating insights	Exploratory Data Analysis (EDA) in Big data	Sai Bharath	15
		Map Reduce Illustration in Depth for a EDA task		15
		Pre Processing/Data Preparation	Debayan Roy	30
		Data Insight communication - Industry use case		30
8 October	Day 4: Big data analytics Life cycle	Tools used in analytics - Jupyter, GIT, Python and Pyspark	Divya	30
		Analytics methodology		30
		Image analytics - Industry use case	Shreyans	30
9 October	Day 5: Big data analytics Life cycle	Concept of Sampling data, Use case	Divya	45
		Fraud analytics - Industry use case	Srujan	45
10 October	Day 6: Big data analytics in Industries (11-1)	Dealing with unstructured data, use case	Divya	45
		Sentiment analysis	Jishnu	45
	Big data analytics Way forward (2-4)	Keynote, Moderator	RV team/Dr.Bung	10
		Panel Discussion - each speaker 15 mins for her/his topic	Dr. Bung, Divya, Jishnu, Srujan	70
		Closing note	RV team/Dr.Bung	10



RV Institute of Management®

Affiliated to Bengaluru Central University.

Approved by AICTE, New Delhi. Accredited by NAAC with 'A+' grade.



Rastreeya Sikshana Samithi Trust
R V Institute of Management



Go, change the world

Certificate of Participation

This is to certify that,

CHANDRIKA KRISHNAN

has successfully participated in the One Week Continuing Education Program on “Big Data Analytics” organized by R V Institute of Management, Bangalore, from 5th to 10th October, 2020.

Dr. Purushottam Bung
Professor and Director
R V Institute of Management



FDP on 'Quantitative Data Analysis using R'

Date: 2 nd -11 th Nov, 2020	Venue: Webinar / Zoom meeting
Time: 04.30pm to 06.00pm	Event : Faculty Development Program
No. of Participant: 120	Event Convener: Dr. Purushottam Bung, Dr. Padmalini Singh Event Coordinator: Prof. Priya Jain

Objectives

- The FDP was intended to support researchers, consultants, and data analysts to:
 - Have a clear understanding of fundamentals of quantitative research
 - Have hands on R software tools for data analysis
 - To help them acquire a new skill set by learning R

Agenda/Flow of the Event

(Dr. Ashish Singh, IIT Bombay) 04:00 PM - 06:00 PM		(Mr. Shankar MM) Mentor – CARES, Bangalore) 04:00 PM - 06:00 PM
Session 1 2 nd Nov, 2020 (Monday) Measurement & Scaling	Session 2 2 nd Nov, 2020 (Monday) Measurement & Scaling	Workshop Session 11 7 th Nov, 2020 (Saturday) Introduction to R (Basics)
Session 3 3 rd Nov, 2020 (Tuesday) Questionnaire Design	Session 4 3 rd Nov, 2020 (Tuesday) Data coding	Workshop Session 12 8 th Nov, 2020 (Sunday) Testing of Hypothesis (Parametric & Non-Parametric tests)
Session 5 4 th Nov, 2020 (Wednesday) Sampling & Sampling Distribution	Session 6 4 th Nov, 2020 (Wednesday) Sampling & Sampling Distribution	Workshop Session 13 9 th Nov, 2020 (Monday) Correlation & Regression
Session 7 5 th Nov, 2020 (Thursday) Hypothesis testing	Session 8 5 th Nov, 2020 (Thursday) Inferential statistics (including testing of statistical significance)	Workshop Session 14 10 th Nov, 2020 (Tuesday) Exploratory Factor Analysis And alpha assessment
Session 9 6 th Nov, 2020 (Friday) Multivariate analysis	Session 10 6 th Nov, 2020 (Friday) Correlation and Regression (testing and interpretation)	Workshop Session 15 11 th Nov, 2020 (Wednesday) Overall Practical Approach towards questionnaire-based data analysis using R

Outcome Achieved/ Attained:

The FDP was designed in two parts wherein first 5 days Dr. Ashish Singh, Assistant Professor, IIT Bombay delivered the fundamentals of quantitative research, clearing the concepts right from measurement and scaling, questionnaire design and data coding, sampling and sampling distribution, Hypothesis testing and data analysis. Once the participants gained conceptual clarity, rest 5 days were dedicated for workshop where participants were simultaneously practicing the fundamentals of quantitative research right from measurement and scaling, questionnaire design and data coding, sampling and sampling distribution, Hypothesis testing and data analysis. This approach of theory followed by practice was successful in the following ways:

- Participants had a better understanding about the fundamentals of quantitative research right from measurement and scaling, questionnaire design and data coding, sampling and sampling distribution, Hypothesis testing and data analysis.
- Participants were able to understand the basics of R programming.
- Participants were able to run the codes following the expert and practicing simultaneously on their own. They were able to generate the results.
- Participants were able to do the basic statistical analysis using R.
- The FDP was helpful for academicians, researchers, consultants and executives to use R for the quantitative research.

10 days FDP was completely appreciated by the participants. The expert's talk followed with the workshop was very helpful in practicing the concepts learnt by the participants.



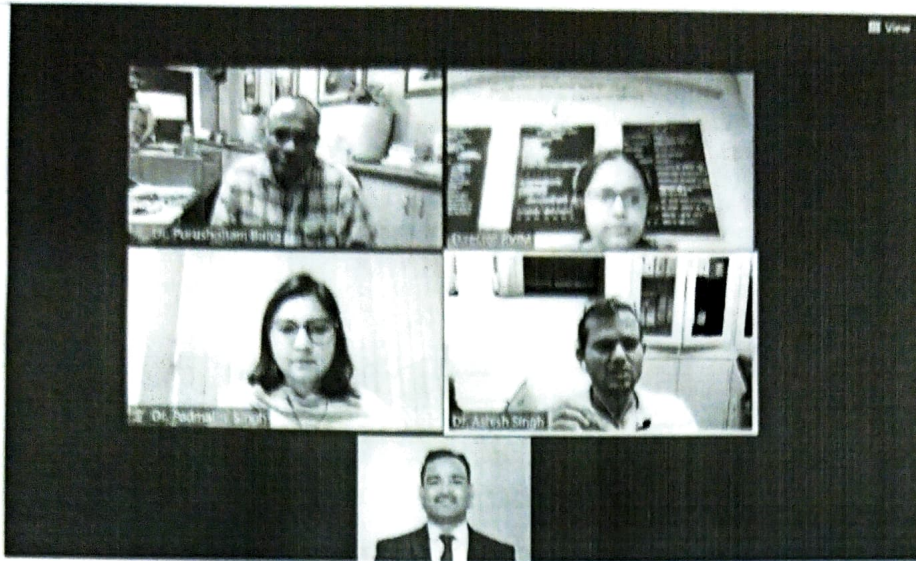

Feedback & Coordinator Comment:

The FDP program was received much appreciation by all the participants. The participants also valued and enjoyed the interaction with the experts as well as during the FDP. The participants have requested to organize FDPs and workshop on research in future too.

Event Convener: Dr. Padmalini Singh,

Event Coordinator: Prof. Priya Jain



[Handwritten Signature]
Director

Annexure 1	Proposal / Approval
Annexure 2	Circular / Brochure of the event
Annexure 3	Brief profile of the speaker
Annexure 4	Attendees list
Annexure 5	Photo Gallery
Annexure 6	Detail Feedback (if required)
Annexure 7	Any other related documents



2 Days SDP

on

Understanding the Nuances of Online Trading

Date: 29th and 30th December 2020

Venue: Zoom webinar

Time: 11 am to 1 pm

Event : Webinar

No. of Participant: 180

Event Coordinator: Prof. Dileep
Prof. Priya Jain
Prof. Vallabh N
Prof. Pooja T

Objectives

- To gain deeper understanding of fundamental concepts related to investing
- To understand the basics of stock trading
- To understand the concepts related to fundamental analysis and valuation techniques
- To understand the basic concepts of technical analysis for beginners
- To understand basics of trading through live demonstration

Agenda/Flow of the Event

- 29th June- Introduction to the World of trading and basics of valuation
- 30th June- Live trading and basics of Technical Analysis

Outcome Achieved/ Attained:

- Dr Bung started the SDP on 29th December with the introduction and importance of investing and trading. He explained the role of savings and how wealth should be created. Dr. Bung also took the audience through a brief evolution of capital markets in India and provided some interesting statistics. He explained wealth creation using stocks by illustrating the growth story of Infosys since its IPO.
- The proceeding then was taken over by the resource person Mr. Himanshu Mayne. With a flair for finance, the resource person thoroughly engaged the audience on day one with important fundamental concepts that one must know for effective stock picking like P/E Ratio, EPS etc. He explained a few strategies like valuation and how to effectively identify undervalued stock for superior gains.

- On day 2 of the SDP, the resource person demonstrated live trading and took the audience through the process of basics of technical analysis like support and resistance, trend analysis, RSI etc. He also enlightened the new traders about the pitfalls that one must be aware of.

Feedback & Coordinator Comment:

The entire program was very well received by all the participants. Everyone appreciated the efforts of the resource persons and have their interest to attend many more such sessions. Motivating and encouraging participants to take up stock trading by equipping them with the basic skills required was the key highlight of the two day SDP.

Event Coordinator(s)

Prof. Dileep



Prof. Priya Jain



Prof. Vallabh N

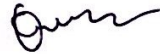

Prof. Pooja T

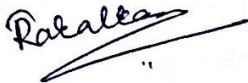

Director

Dr. Purushottam Bung

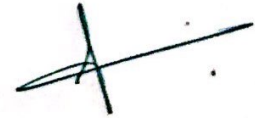



RASHTRIEYA SIKSHANA SAMITHI TRUST
R V INSTITUTE OF MANAGEMENT
CA 17, 26 Main, 36th Cross, 4th T Block, Jayanagar
Bengaluru, Karnataka 560 041



Report on FDP on 'Learning Management from Gitopanishads.'	
Date: 22nd February'21 to 26th Feb'21.	Venue: RV Institute of Management
Time: 4.00 to 5.00pm	Faculty In charge – Dr. Anupama Malagi
About the FDP: Management Lessons from Gita, Ramayana, Mahabharat and Upanishads- the objective of the FDP: <ul style="list-style-type: none">• Bring out the management lessons given by each of the scriptures -Ramayana, Mahabharat, Upanishads and Bhagavad Gita.• The richness and depth of these ancient scriptures the type of knowledge they give to today's millennial world.	

Details of the FDP

Resource Persons of the FDP -

Dr A H Chachadi. Former Dean and Director Kaushali Institute of Management.

Dr.M.R. Dixit Former Professor -IIM-A.

The Five Day FDP:

Day One: Lessons from Bhagavad Gita: Introduction and overview of Bhagavad Gita, the context of in which the scripture is narrated. Lessons given to Arjuna. as a lesson for all.

Day Two Lessons from Ramayana -Overview and elaboration of the story of Ramyana and the characters of the story was brought out.

Ramayana lessons of managing interpersonal and organizational skills was elaborated. Instances of each character is used to bring out the lessons of failure, struggle and the ability to work and persevere to achieve goals is explain through certain characters as Hanuman and Jatayu.

Day Three Lesson from Mahabharat: Central story being family feud the resource person provided such an analysis of each main character that Mahabharat is elevated to a managerial context and decision-making is highlighted as the being the key to deciding the next situation for each character.

Day Four-Lessons from Chanakya Nethi – A historic writing that is distinct from the holy scriptures ,it more a political commentary book of those.

[Handwritten signature]



Day Five Upanishads: These scriptures bring out the disciplined life that is basis for any planned or well achieved work. The event had more than 200 participants from all over India.



RV Institute of Management
Go change the world

Rashtriya Sikshana Samithi Trust

R V Institute of Management
CA 77, 26th Cross, 25th Main, 4th T Block, Jayanagar Bangalore - 560 041
Ph: 080-26547088 Fax: 0805484330 E-Mails: rvim@rvim.edu Email: contact@rvim.edu

5 Days FDP on
**Learning Management from
Gitopanishads**

The FDP will focus on lessons from
Bhagavad Gita, Ramayana, Mahabharatha,
Chanakya Neethi and Upanishads.

Date : 22.02.2021 to 26.02.2021 (Monday to Friday)
Timings : 4.00pm-5.30pm
Registration Fees : Rs 250/- for faculty members & Rs 100/- for students.

**Resource Person**
Dr A H Chachadi
Former Dean & Director,
Kousali Institute of Management Studies,
Karnatak University, Dharwad

Moderator

**Prof M R Dixit**
Former Professor,
IIM Ahmedabad

**Dr Purushottam Bung**
Director, RVIM

Click the following Link to Register :
<https://forms.gle/hGWSngQLZub6GwdITZ>

Co-ordinators:
Prof Sowmya D S (9740165784)
Prof Ramya S (9741849806)

Programme Co-ordinator
Dr Anupama K Malagi
Professor
Contact details: anupama@rvim.edu.in
Mob: +91 9448079732

Faculty In-Charge
Dr. Anupama Malagi

Director
RVIM.



Report on Capacity Building Workshop on Research for Faculty Members at RVIM.

Date: 27th February 2021, 20th March, 2021
and 27th March, 2021

Venue: Workshop Hall

Time: 9.00 am to 1.00 pm

Event : Workshop

No. of Participants: 18

Event Coordinator: Prof. Nagasubba Reddy

Objectives

The objective of this Capacity Building Workshop is to Enable faculty to publish in Scopus and other reputed journals.

Flow of the Event

Session Details

Session 1	<ol style="list-style-type: none">1. Selection of Journals2. Identifying prospective areas3. Identifying base papers4. Identifying co-authors (Indian and foreign)5. Methods of extension
Session 2	<ol style="list-style-type: none">1. Data procurement2. Methodology finalization3. Writing conclusion and interpretation4. Writing literature review
Session 3	<ol style="list-style-type: none">1. Usage of Mendeley for both in text citation and bibliography2. Writing introduction and formulating abstract3. Techniques for JEL codes4. Native english writing skills.



Annexure 1

ATTENDANCE/ LIST OF PARTICIPANTS

Annexure 2	Photo Gallery
------------	---------------

Annexure 1- ATTENDANCE/ LIST OF PARTICIPANTS

The Following Faculty members attended the workshop



Rashtreeya Sikshana Samithi Trust
RV INSTITUTE OF MANAGEMENT

Workshop on
"Enabling faculty to publish in Scopus"
Conducted by
Dr. Bikramditya Ghosh

27/03/21

Sl.No.	Name	27/03/2021	29/03/2021
1.	Dr. Noor Firdoos Jahan	[Signature]	[Signature]
2.	Dr. Anupama K Malagi	[Signature]	[Signature]
3.	Dr. A. Narasima Venkatesh	[Signature]	[Signature]
4.	Dr. Santhosh M	[Signature]	[Signature]
5.	Dr. N. Suresh	[Signature]	[Signature]
6.	Prof. Amtha BM D'Silva	[Signature]	[Signature]
7.	Prof. N. Nagasubba Reddy	[Signature]	[Signature]
8.	Prof. A. Chandran	[Signature]	[Signature]
9.	Prof. Sowmya D S	[Signature]	[Signature]
10.	Prof. Rashmi Shetty	[Signature]	[Signature]
11.	Prof. Payal Jindal		
12.	Prof. S K. Manjunath		
13.	Prof. Ramya S	[Signature]	
14.	Prof. Dileep. S	[Signature]	
15.	Prof. Uma Sharma	[Signature]	[Signature]
16.	Dr. Padmalini Singh	[Signature]	[Signature]
17.	Prof. Vandana Gabrani	[Signature]	[Signature]
18.	Prof. Sreevallaban Narayanan	[Signature]	[Signature]
19.	Prof. Pooja Ravindra Takalkar	[Signature]	[Signature]
20.	Prof. Shreya Shankar	[Signature]	[Signature]

Dr. Purushottam Bung
Professor and Director
RV Institute of Management

[Signature]
Dr. Bikramditya Ghosh
Professor
RV Institute of Management

Annexure 2

Session Screenshots/ Photo Gallery

Artificial intelligence was introduced by Hinton in 1981(Lecun et al., 2015). Deep learning was used initially for pattern recognition(Zhang et al., 2020).

Finance researchers and quantitative finance practitioners found that EMH isn't present in reality, on the contrary FMH stays close to real(Fama, 1970; Mandelbrot & Wheeler, 1983; Sharpe, 1964).

Citations

Fama, E. F. (1970). Efficient Market Hypothesis: A Review of Empirical Work. In *The Journal of Finance* (Vol. 25, Issue 2, pp. 383–417).

Lecun, Y., Bengio, Y., & Hinton, G. (2015). Deep learning. *Nature*, 521(7553), 436–444. <https://doi.org/10.1038/nature14539>

Mandelbrot, B. B., & Wheeler, J. A. (1983). The Fractal Geometry of Nature. In *American Journal of Physics* (Vol. 51, Issue 3, pp. 286–287). <https://doi.org/10.1119/1.13295>

Sharpe, W. (1964). CAPITAL ASSET PRICES: A THEORY OF MARKET EQUILIBRIUM UNDER CONDITIONS OF RISK. *Journal of Finance*, 19(3), 425–442.

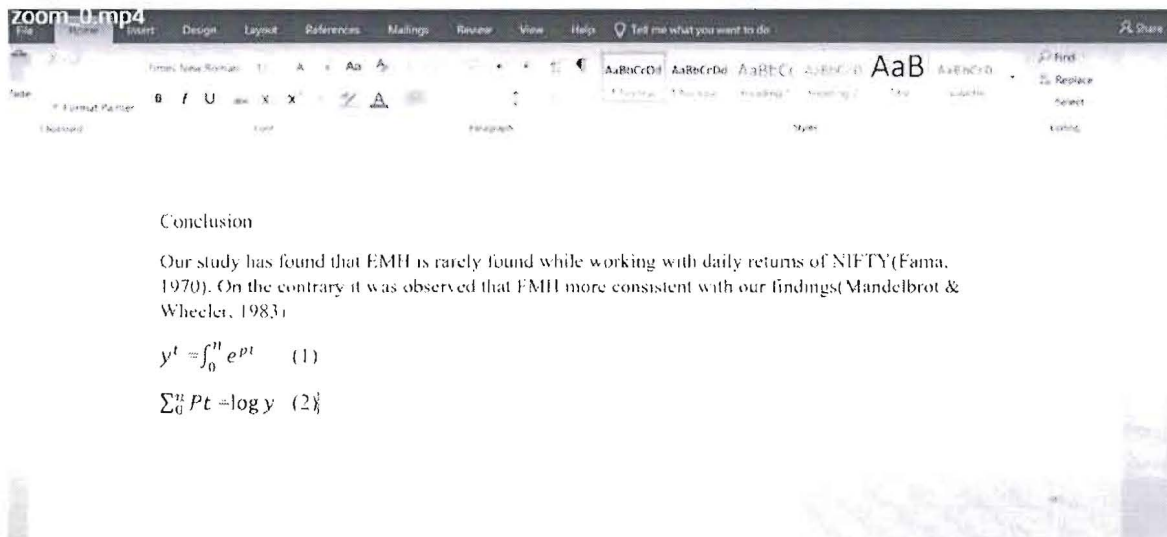

zoom_0.mp4

Press Esc to exit full screen

AaB

Traditional portfolio theories stress on the assumption that a rational investor is one who is risk averse and will maximize utility from investments without any biases. In other words, a rational investor will try to maximize returns which leads to utility maximization. Traditional portfolio theories ignore the fact that psychological influences and cognitive biases can work against the investors' ability to make good returns. In reality, these biases play a vital role in deciding how investors look and perceive events affecting their investment decisions. This is what Behavioral Finance attempts to do.

When we discuss effective asset allocation, the basic objective is to achieve near optimum diversification so that the overall portfolio risk can be mitigated and the returns can be maximized for the given set of risk constraints.

Let us look at a few basic biases that plagues investor rationality before we look at familiarity bias in detail. Then we will attempt to look at the three most common risks that rears its head during a crisis. We shall subsequently look at the role of familiarity bias in this entire investment universe during COVID.

1. **Contrast Bias:** It is based on the natural human tendency to compare two similar objects / events and upgrade or downgrade one against the other.
2. **Recency Bias:** This is a commonly recurring theme where the human mind

0:10 / 1:45:09

Director



Live Webinar on Business Analytics- Way Forward Education and Industry			
Date: 4 th and 5 th June 2020		Venue: Zoom webinar	
Time: 5 pm to 7 pm		Event : Webinar	
No. of Participant: 295		Event Coordinator: Dr. Santhosh M Prof. Reddy Prof Dileep Prof. Priya Jain	
Objectives			
<ul style="list-style-type: none"> - To gain the knowledge of Evolution of Business Analytics and its applications in the area of management. - To know the Curriculum Framework of Business Analytics. - To understand why business analytics is increasingly becoming an important tool to stay a Market Leader and how it is being used in Industry? - To understand the Need for Academia to prepare students in areas of Applications & Specializations, especially how to define problems and Model them for Analytics. 			
Agenda/Flow of the Event			
Sl No	Content	Presenter	Time
4th June (Thursday) 5.00 pm to 6.30 pm			
1	Business Analytics – Evolution & Trends <i>How the need for Analytics came up due to explosion of Data from Social Media.</i> <i>World & India Trends in BA</i>	Dr Purushotham Bung, Director RVIM	1700 to 1715 15 mts
2	Business Analytics Landscape	Dr. Ramesh Rajagopalan Founding Partner, SetCONNECT Previously Faculty and Director of MSBA at UT McCombs School of	1715 to 1730 15 mts

		Business	
3	Applications of Business Analytics in Industry <i>Why BA is increasingly becoming an important tool to stay a Market Leader and how it is being used in Industry?</i>	Mr. Doug Gray Director, Global Data - Data Science & Value Realization at Walmart	1730 to 1815 45 mts
4	Q&A		1815 to 1830 15 mts

Sl No	Content	Presenter	Time
5th June (Friday) 5.00 pm to 6.30 pm			
1	Business Analytics Educational Framework <i>Curriculum Framework of Business Analytics</i> <i>Why is industry partnership essential for BA programs?</i> <i>Best practices followed by leading Universities</i>	Dr Ramesh Rajagopalan Founding Partner, SetConnect Previously Faculty and Director of MSBA at UT McCombs School of Business	1700 to 1745 45 mts
2	Business Analytics - An opportunity for Academia <i>Increasing demand for BA professionals in Areas of Management, not just coders.</i> <i>Need for Academia to prepare students in areas of Applications & Specialisations, especially how to define problems and Model them for Analytics.</i>	Mr C S Venkatesh Founding Director SetConnect	1745 to 1800 15 mts
3	Q&A		1800 to 1815 15 mts
4	Summing up <i>Summarising the two day FDP & Learnings.</i> <i>Announcing the RVIM FDP on "Applications of Analytics in the Areas of Management"</i>	Dr Purushotham Bung, Director RVIM	1815 to 1830 15 mts

Outcome Achieved/ Attained:

- Dr Bung started the webinar on 4th June 2020 with *How the need for Analytics came up due to explosion of Data from Social Media*. In his talk, he explained that Data & Business Analytics has been prevalent in Business for ages. However, the way in which Business Analytics is being done has changed rapidly over the years with the advent of Social Media and consequent advent of Big Data.
- Dr. Ramesh reiterated the points highlighted by Dr Bung that there is huge gap in Business Analytics Talent supply. He went on to explain that Business Analytics is a scientific process of transforming Data in to Insights for better decision making. He went on to explain how Analytics has evolved from Descriptive to Predictive, Prescriptive and Cognitive.
He explained the Landscape for teaching Business Analytics at three levels – Foundation, Application and Specialization in all the Business domains of Sales, Marketing, Finance, and Operations & HR.
- Mr. Doug Gray highlighted that it is difficult for Technology & Data Science to do well in Industry and went on to explain the Top 10 reasons why Business Analytics Projects fail in Industry. He went to explain the importance of defining the Problem properly and having a clear Objective/KPIs (Key Performance Indicators). There is a need to develop the Skill sets for defining the problem. He then went on to explain the other reasons for failure in Industry :
 - 1) Data Issues. Having the Right data in right form
 - 2) Misapplying the model. Need for proper Experimental Design.
 - 3) Solving a problem that is not a Business priority
 - 4) Communication
 - 5) Change Management
 - 6) Unrealistic Expectations
 - 7) Project Management
 - 8) Excessive focus on the Model, Technique or Technology. Model is a means to an end. Technology keeps changing, Balance between aiming for perfection and Delivery.
 - 9) Getting from Sandbox Model to Production System

Feedback & Coordinator Comment:

The entire program was very well received by all the participants. It was a wonderful experience to learn from foreign speakers how actually analytics works in industry. All the participants understood the importance of analytics in today's scenario and also the need for Academia to prepare students in the areas of analytics.

Event Coordinator(s)

Director

N. Anand (Prof. Nagasubha Reddy)
K. Praveen (Asst. Santhosh M)
Dilali (Prof. Dileep)
Priya (Prof. Priya Jain)

Annexure 1	Proposal / Approval	Not applicable
Annexure 2	Circular / Brochure of the event	Attached
Annexure 3	Brief profile of the speaker	Attached
Annexure 4	Attendees list	On zoom
Annexure 5	Photo Gallery	Attached
Annexure 6	Detail Feedback (if required)	attached
Annexure 7	Certificate copy	attached

Annexure 2
Circular / Brochure of the event
Brochure



RV Institute of Management

Live Webinar

Business Analytics- Way Forward

Education and Industry







SetCONNECT

Click to Register
In case of queries, contact Priya @ 9108300728,
priyajain.rvim@rvei.edu.in

4th and 5th June 2020
 5-7 PM IST

THE PANELISTS:

 <p>DR. PURUSHOTTAM BUNG Director, RVIM, Bengaluru India</p> <div style="border: 1px solid black; padding: 5px; width: fit-content; margin: 0 auto;"><p>TOPICS:</p><ul style="list-style-type: none">• Evolution of Business Analytics• Applications of Analytics in the areas of Management.</div>	 <p>DR. RAMESH RAJAGOPALAN Founding Partner, SetConnect USA</p> <div style="border: 1px solid black; padding: 5px; width: fit-content; margin: 0 auto;"><p>TOPICS:</p><ul style="list-style-type: none">• Business Analytics Landscape• Business Analytics Educational Framework</div>	 <p>MR. DOUG GRAY Director-Global Data, Walmart USA</p> <div style="border: 1px solid black; padding: 5px; width: fit-content; margin: 0 auto;"><p>TOPIC:</p><p>Business Analytics - Applications in Industry</p></div>	 <p>MR. C S VENKATESH Founding Partner, SetConnect India</p> <div style="border: 1px solid black; padding: 5px; width: fit-content; margin: 0 auto;"><p>TOPIC:</p><p>Business Analytics - An opportunity for Academia</p></div>
---	--	---	--

Annexure 3
Brief profile of the speaker

Brief Profile of the Resources Persons

1. Dr. Ramesh Rajagopalan, Founding Partner, SetConnect Inc.; Ex-Faculty & Director of MSBA at UT McCombs School of Business, USA



Dr. Ramesh Rajagopalan is a seasoned leader with over 20 years of industry experience in leading large teams and delivering customer value in the areas of Marketing Analytics, Blockchain Technologies, Cloud Computing, Supply Chain and Business Strategy. Dr. Rajagopalan has a unique blend of academic and

Page 5 of 12

corporate leadership experience. He has held senior faculty positions at various leading universities including the University of Texas Austin McCombs School of Business. He has held leadership positions in academia as well as in large corporations such as Dell, Deloitte Consulting and IBM. He currently serves as a strategist and advisor to senior executives at global corporations as well as federal agencies. He provides leadership and guidance in the areas of business analytics, data science, marketing, healthcare and supply chain. Most recently he led a global marketing analytics team at Dell. Under his direction, his team implemented advanced analytics solutions leveraging “big data” to predict, classify and target high value customers. His team delivered several hundred million \$ revenue impact to the organization. Prior to this role, Ramesh served as the global practice executive in the Cloud Computing practice at Dell Services. He led a team of pre-sales strategists, cloud experts; engaged in strategic sales/account planning and generated multi-million \$ in revenue. In leadership roles at Dell and prior to Dell including SmartOps (now SAP), Deloitte, IBM and i2 Technologies (now JDA), Ramesh led diverse global analytics teams and was responsible for delivering multi-million \$ cost savings at several Global 100 companies. Dr. Rajagopa is driven by his passion for industry-university collaboration. Throughout his career he is privileged to work with executives from global companies striving to drive business value through analytics.

He is an internationally recognized speaker and industry expert in Advanced Analytics, Customer Insights, Supply Chain, and Digital Strategy.

Career Highlights:

- Unique blend of academic and corporate leadership experience
- Senior role directing Master of Science in Business Analytics (MSBA) at UT Austin McCombs School of Business
- Leadership roles at Dell, Deloitte Consulting and IBM
- Globally recognized speaker and expert in the area of Business Analytics

2. Doug Gray, Director, Global Data at Walmart, USA

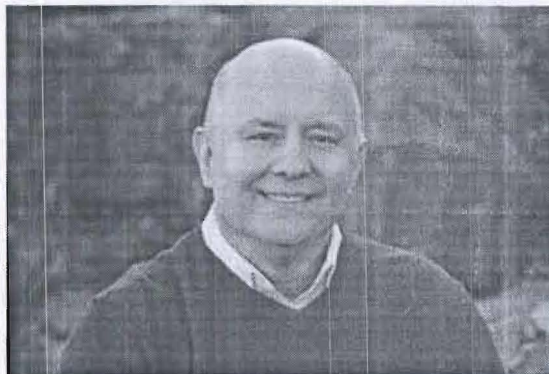

Doug Gray is a senior executive leader specializing in integrating Data & Analytics into Corporate

Strategy across the enterprise to achieve measurably impactful, sustainable strategic competitive advantage; considerable expertise in leading large-scale programs involving sophisticated business systems design, delivery execution, and operations leveraging Analytics, Data Science, Business Intelligence and Information Technology to generate significant, tangible economic value & business impact across a variety of industries, including most notably Airline, Travel & Hospitality, Health Care, and Financial Services. Key core experience, expertise, qualifications & capabilities include: Advanced Predictive & Prescriptive Analytics Data Science, AI & Machine Learning Exceptional Strategic Planning & Execution Skills Complex Enterprise Operations Optimization.

Career Highlights:

- A seasoned corporate executive and a proven leader
- Adjunct professor of Business Analytics at Southern Methodist University (SMU) Data Science Program and Cox School of Business
- Leadership roles at Walmart, Southwest Airlines, BMC Software, AMR Corporation, Sabre Technologies
- Renowned speaker and expert in the area of Data Science, Corporate Leadership and Business Analytics

3. Mr. C.S Venkatesh

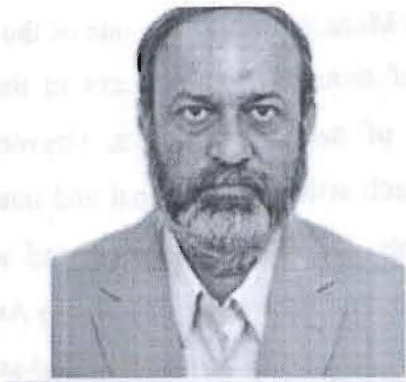

Mr Venkatesh is the Founder and CEO of MetaCog Solutions Pvt. Ltd., Bangalore.

MetaCog Solutions provides skill development solutions in the supply chain and operations management areas. Affiliated with the Automotive Skill Development Council and the Indian Institute of Materials management, the company provides industry-focused, role-based training for working professionals and students wishing to make a career in supply chain management.

Before starting MetaCog, Mr Venkatesh set-up and managed Fugo Creative, a graphic design company and Sirius Consulting Pvt Ltd – a rural BPO which provided mortgage processing services for the US market.

Prior to his serial entrepreneur journey, he was Director, Sales Consulting for i2 Technologies in India and worked with key Indian customers including Maruti Udyog, Indian Oil Corporation and Agro Tech Foods. He also held positions in Baan Asia Pacific, Singapore Technologies, ITC Infotech, Cummins India and NIIT. He has had roles in managing development, consulting and pre-sales with a focus on in the areas of manufacturing and supply chain management for automotive and electronics industries.

Mr Venkatesh holds a bachelor's degree in engineering from KREC Surathkal, and an MBA from XLRI, Jamshedpur.

4. Dr Purushottam Bung, Professor and Director at RV Institute of Management



Dr. Purushottam Bung is an engineer with a rich experience of around 26 plus years in Academia and industry (domestic and international). He completed PGDM from Melbourne Business School, Australia, one of the top 10 B-schools in the world and MBA from Monash University, one of the top universities in the world. He has a rich entrepreneurial experience of around 10 plus years in the food processing industry. He is on the expert/advisory/editorial panel of many Institutions, Universities, NGOs and journals. Dr. Bung has presented and published 22 research articles in national and international refereed journals and undertaken several consultancy assignments. Dr. Bung was conferred with “Enterprising Academic Leader of the year (South India)” as part of National Education Excellence Awards in 2018. He was conferred with “Distinguished Educator” award in 2013. In 2015 he was awarded as ‘Best Director of a B-school in Karnataka’ as part of education excellence awards – 2015. He is member of many Associations and Institutional bodies. He is elected as FELLOW of World Academy of Productivity Sciences at Beijing, China recently. He is also a research fellow of Institute of Productivity, UK. Dr. Bung is offering management consultancy services to local Businesses, Institutions and entrepreneurs as well. Very recently he has completed a HarvardX course in collaboration with Pearson Global and Ureka Education group, UK on ‘Future of Learning’ anchored by Prof. Richard Elmore, Professor and authority in Education and Learning from Harvard.

Annexure 5 Photo Gallery

Dr. Ramesh Rajagopalan is a seasoned leader with over 20 years of industry experience in leading large teams and delivering customer value in the areas of Marketing Analytics, Blockchain Technologies, Cloud Computing, Supply Chain and Business Strategy.

Dr. Rajagopalan has a unique blend of academic and corporate leadership experience. He has held senior faculty positions at various leading universities including the University of Texas, Austin, McCombs School of Business. He has held leadership positions in academia as well as in large corporations such as IBM, Deloitte Consulting and IBM.

Most recently he led a global marketing analytics team at Dell. Under his direction, his team implemented advanced analytics solutions leveraging "Big Data" to profile, classify and target high value customers. His team delivered several hundred million \$ revenue impact to the organization. Prior to this role, Dr. Rajagopalan served as the global practice executive in the Cloud Computing practice at Dell Services.

He is an internationally recognized speaker and industry expert in Advanced Analytics, Customer Insights, Supply Chain and Digital Strategy.

Dr. Ramesh Rajagopalan
Founding Partner, In-Corner Inc.,
Ex-Faculty & Director of MBA at
UT McCombs School of Business,
USA

US University Trends

- First responders are the Business schools
- One-year Master's programs in Business Analytics
- NC State University may have been the first one
- Followed by many including UT McCombs, Duke, Columbia with rigorous 10-month programs
- Programs expanded to target working professionals offered by Northwestern (on line) and Harvard (9-month program)
- Southern Methodist University (SMU) has a highly quantitative blended Master's in Data Science program

Pre-Covid survey: (Kaplan University and Quora Research)
 Value of education vs high data
 Importance of work experience
 Marketable skills and social skills, critical thinking

Disruption in the Landscape

Pandemic
 Economic uncertainty
 Cost and Value

Business Analytics Educational Framework

Dr. Ramesh Rajagopalan
 Faculty Partner, MITADNOC2019
 Ramesh.Rajagopalan@mitadnoc2019.net

RV Institute of Management

Business Analytics: Way Forward Education & Industry

Date: 5th June 2020

Dr. Doug Gray

Applications of Business Analytics in Industry

Contextual Lens:
 The Top 10 Reasons
 Data Science Projects Fail

Doug Gray
 Adjunct Professor, Business Analytics & Data Science
 Southern Methodist University (SMU)
 Dallas, Texas

Global Talent Challenge

Analytics Talent is in Short Supply

- Analytics of higher education have a challenge and an opportunity to expand the career pathways that lead to a diverse analytics workforce needs.

Dr. Ramesh Rajagopalan

Doug's Top 10 Reasons Data Science Projects Fail

1. Not understanding the real business problem

Use Data to Answer Your Key Business Questions

What is the "target" for improvement?
 KPI - Key Performance Indicator
 BQ - Key Business Question

Annexure 6

Detail Feedback (Attached)

Webinar was well organized

295 responses

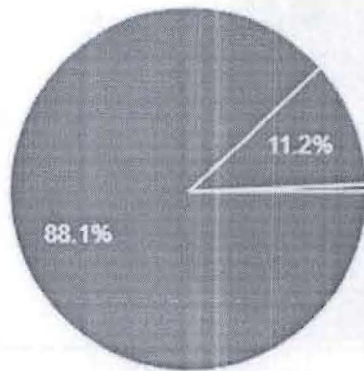

- Strongly Agree
- Agree
- Neutral
- Disagree

Webinar helped me in enhancing my knowledge on the topic

295 responses

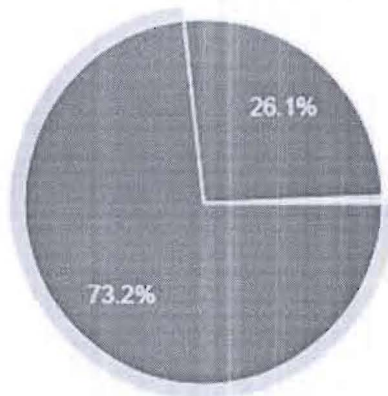

- Strongly agree
- Agree
- Disagree
- Neutral

The information presented were relevant and useful

295 responses

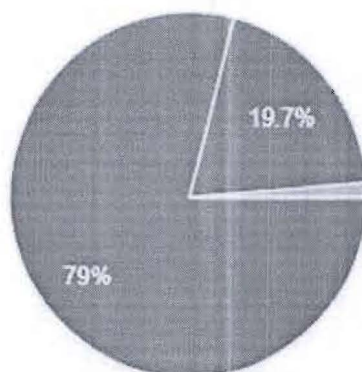

- Strongly Agree
- Agree
- Neutral
- Disagree

The presenter(s) provided adequate time for questions and answered them satisfactorily

295 responses

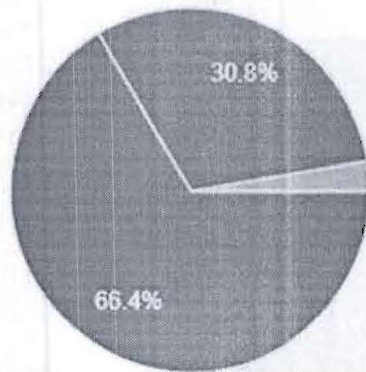

- Strongly Agree
- Agree
- Neutral
- Disagree

Annexure 7

Certificate Copy Attached



RV Institute of Management®

Approved by AICTE,
New Delhi. Accredited
by NAAC with A+ grade.

Affiliated to Bangalore
Central University

*Go, change
the world*



Rashtreeya Sikshana Samithi Trust

R V Institute of Management

CA 17, 36th Cross, 26th Main, 4th T'Block, Jayanagar, Bangalore – 560 041

Ph: 080-26547048 Fax: 26654920; URL: rvim.edu.in Email: contact.rvim@rvei.edu.in

E-CERTIFICATE

This is to certify,

Sowjanya Bhat B

R V Institute of Management

has successfully participated in Two Day Live Webinar on “**Business Analytics – Way Forward Education and Industry**” held by R V Institute of Management, Bangalore on 4th & 5th June, 2020.

Dr. Purushottam Bung
Professor and Director
R V Institute of Management



Vision : To Become World Class Management Institute of Eminence



RV Institute of Management®

Approved by AICTE, New Delhi. Accredited by NAAC with 'A+' grade. Affiliated to Bengaluru Central University.

*Go, change
the world*

Rashtreeya Sikshana Samithi Trust

R V Institute of Management

CA 17, 36th Cross, 26th Main, 4th 'T' Block, Jayanagar, Bangalore – 560 041

Ph: 080-26547048 Fax: 26654920; URL: rvim.edu.in Email: contact.rvim@rvei.edu.in



E-CERTIFICATE

This is to certify,

Venkatesan D

SRM IST

has successfully participated in Two Day Live Webinar on “Business Analytics – Way Forward Education and Industry” held by R V Institute of Management, Bangalore on 4th & 5th June, 2020.

Dr. Purushottam Bung
Professor and Director
R V Institute of Management



Vision : To Become World Class Management Institute of Eminence



RV Institute of Management

Approved by AICTE, New Delhi. Accredited by NAAC, with 'A+' grade. Alliliated to Bengaluru Central University.

*Go, change
the world*



Rashtreeya Sikshana Samithi Trust

R V Institute of Management

CA 17, 36th Cross, 26th Main, 4th 'T' Block, Jayanagar, Bangalore – 560 041

Ph: 080-26547048 Fax: 26654920; URL: rvim.edu.in Email: contact.rvim@rvei.edu.in

E-CERTIFICATE

This is to certify,

Mr Chandan Kumar Singh

Sachchidanand Sinha college Aurangabad

has successfully participated in Two Day Live Webinar on “**Business Analytics – Way Forward Education and Industry**” held by R V Institute of Management, Bangalore on 4th & 5th June, 2020.

Dr. Purushottam Bung
Professor and Director
R V Institute of Management

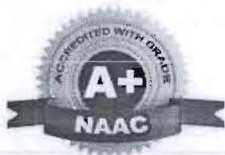

Vision : To Become World Class Management Institute of Eminence

Attendee Report
Report Generated:

6/6/2020 15:20

Topic	Webinar ID	Actual Start Time	Actual Duration (minutes)	# Registered	# Cancelled	Unique Viewers	Total Users	Max Concurrent Views
Business Analytics Way Forward- Education and Industry Host Details	955 1250 8798	6/4/2020 16:18	181	548	0	345	907	292

Attended	User Name	Email	Join Time	Leave Time	Time in Session (minutes)	Country/Region Name
Yes	Director RVIM	director.rvim@rvei.edu.in	6/4/2020 16:18	6/4/2020 19:19	181	India

Attended	User Name	Email	Join Time	Leave Time	Time in Session (minutes)	Country/Region Name
Yes	Mr C S Venkatesh	cs.venkatesh@setcoconnect.net	6/4/2020 16:51	6/4/2020 16:58	7	India
Yes	Mr C S Venkatesh	cs.venkatesh@setcoconnect.net	6/4/2020 16:58	6/4/2020 19:19	141	India
Yes	Dr. Santhosh M	santhoshm.rvim@rvei.edu.in	6/4/2020 16:23	6/4/2020 19:19	176	India
Yes	Mr Doug Gray	douglas.gray@walmart.com	6/4/2020 17:17	6/4/2020 19:19	123	United States of America
Yes	Prof. Nagasubba Reddy	nnsreddy.rvim@rvei.edu.in	6/4/2020 16:39	6/4/2020 16:41	3	India
Yes	Prof. Nagasubba Reddy	nnsreddy.rvim@rvei.edu.in	6/4/2020 16:42	6/4/2020 19:19	157	India
Yes	Dileep RVIM	dileep.rvim@rvei.edu.in	6/4/2020 16:19	6/4/2020 19:19	181	India
Yes	Dr. PURUSHOTTAM BUNG	drbung.rvim@rvei.edu.in	6/4/2020 16:45	6/4/2020 19:19	154	India

Attendee Report

Report Generated: 6/6/2020 15:16

Topic	Webinar ID	Actual Start Time	Actual Duration (minutes)	# Registered	# Cancelled	Unique Viewers	Total Users	Max Concurrent Views
Business Analytics Way Forward- Education and Industry	955 1250 8798	6/5/2020 16:29		182	580	0	326	841
Host Details								
Attended	User Name	Email	Join Time	Leave Time	Time in Session	Country/Region Name		
Yes	Director RVIM	director.rvim@rvei.edu	6/5/2020 16:29	#####	182	India		
Panelist Details								
Attended	User Name	Email	Join Time	Leave Time	Time in Session	Country/Region Name		
Yes	Mr C S Venkatesh	cs.venkatesh@setconr	6/5/2020 16:30	#####	181	India		
Yes	Dr. Santhosh M	santhoshm.rvim@rvei.	6/5/2020 16:29	#####	181	India		
Yes	Prof. Nagasubba Reddy	nnsreddy.rvim@rvei.edu	6/5/2020 16:45	#####	166	India		
Yes	Dileep RVIM	dileep.rvim@rvei.edu.	6/5/2020 16:40	#####	19	India		
Yes	Dileep RVIM	dileep.rvim@rvei.edu.	6/5/2020 16:46	#####	14	India		
Yes	Dileep RVIM	dileep.rvim@rvei.edu.	6/5/2020 16:58	#####	152	India		
Yes	Dr. PURUSHOTTAM	drbung.rvim@rvei.edu	6/5/2020 16:35	#####	176	India		
Yes	GuruduttShenoy	Guruduttshenoy@gma	6/5/2020 17:11	#####	139	India		
Yes	Dr Ramesh Rajagop	ramesh.rajagopalan@:	6/5/2020 16:32	#####	178	United States of America		
Attendee Details								
Attended	First Name	Last Name	Email	Registration Tin	Approval Status	Join Time	Leave Time	Time in Session (i
Yes	Suma	latha	psupradeep76@gmail.com	6/3/2020 7:42	approved	6/5/2020 18:08	6/5/2020 18:41	33
Yes	Suma	latha	psupradeep76@gmail.com			6/5/2020 18:53	6/5/2020 18:56	4
Yes	Suma	latha	psupradeep76@gmail.com			6/5/2020 18:03	6/5/2020 18:08	6
Yes	Suma	latha	psupradeep76@gmail.com			6/5/2020 18:46	6/5/2020 18:48	2
Yes	Suma	latha	psupradeep76@gmail.com			6/5/2020 17:11	6/5/2020 17:20	10
Yes	Suma	latha	psupradeep76@gmail.com			6/5/2020 17:21	6/5/2020 17:22	1
Yes	Suma	latha	psupradeep76@gmail.com			6/5/2020 17:22	6/5/2020 17:25	4
Yes	Suma	latha	psupradeep76@gmail.com			6/5/2020 17:35	6/5/2020 17:52	17
Yes	Suma	latha	psupradeep76@gmail.com			6/5/2020 18:48	6/5/2020 18:50	3
Yes	Suma	latha	psupradeep76@gmail.com			6/5/2020 18:59	6/5/2020 19:06	8
Yes	Suma	latha	psupradeep76@gmail.com			6/5/2020 19:06	6/5/2020 19:10	5
Yes	Suma	latha	psupradeep76@gmail.com			6/5/2020 17:30	6/5/2020 17:33	4
Yes	Suma	latha	psupradeep76@gmail.com			6/5/2020 18:41	6/5/2020 18:42	2
Yes	Suma	latha	psupradeep76@gmail.com			6/5/2020 18:42	6/5/2020 18:43	2
Yes	Suma	latha	psupradeep76@gmail.com			6/5/2020 18:43	6/5/2020 18:46	3
Yes	Suma	latha	psupradeep76@gmail.com			6/5/2020 19:10	6/5/2020 19:29	19
Yes	Suma	latha	psupradeep76@gmail.com			6/5/2020 18:01	6/5/2020 18:03	2
No	HEMANT	KUSHWAHA	kushwaha.hemant2@gmail.cor	#####	approved	--	--	--
No	Akash deep	Pandey	akashdeppandey993@gmail.c	#####	approved	--	--	--
Yes	Dr.Srivalli	Jandhyala	Srivallisrivalli7@gmail.com	6/4/2020 9:14	approved	6/5/2020 16:52	6/5/2020 19:30	159
Yes	Ravindra	Reddy M	ravindraoudepts@gmail.com	#####	approved	6/5/2020 17:34	6/5/2020 19:30	116
Yes	Sheetal	Mahendher	sheetal.m@isbr.in	#####	approved	6/5/2020 16:49	6/5/2020 17:19	30
Yes	Sheetal	Mahendher	sheetal.m@isbr.in			6/5/2020 17:19	6/5/2020 18:24	65
Yes	Deepa	Venkatesh	deepiprivi@gmail.com	#####	approved	6/5/2020 17:20	6/5/2020 17:30	10

6/5/2020 19:27:12	pashasif30@gmail.com	Syed Asif Pasha	RV Institute Of Management	Student	Bangalore	Karnataka	7019048592	1) analytics in indian and international context 2)business analytics and its popularity trend 3)business analytics capstone projects 4)major components of business analytics 5) breakdown of business analytics into separate specialisations based analytics 6)online resources and opportunities to learn business analytics 7)major business analytics insights from many reputed business professionals
6/5/2020 19:27:13	khansamreen197@gmail.com	Samreen khanum I K	Grv business management academy	Assistant professor	Bangalore	Karnataka	9380929817	Enough of knowledge reading BA
6/5/2020 19:27:23	arvinddarshna3@gmail.com	Arvind Darshna	Central University of Haryana	Faculty	Mahendragarh	Haryana	7650902166	Quantitative Communication Story Telling fasTrac *Foundation *Application *Specialization *Technology *Real-world Analytics Challenge Social Media Analytics How analytics can be used in every field? How data is changing the world we live in and how our live/study/way of work is going to change? Technology is changing so teachers have to change them too so that they can provide real-world solutions through practical examples. How a business problem can be solved with the help of Data?
6/5/2020 19:27:23	shettykaran24@gmail.com	Karan Ashok Shetty	Seshadripuram Institute of Management Studies	Assistant Professor	Bengaluru	Karnataka	9741334925	
6/5/2020 19:27:27	aditya.gwl3830@gmail.com	Aditya Kumar Pandey	St. Paul's School	Student	Gwalior	Madhya Pradesh	8234820312	1. Got to know about a new domain, which I can take as a career opportunity 2. The scope of career in Business Analytics. 3.
6/5/2020 19:27:33	sagargopal2020@gmail.com	Dr Sagar G	Bangalore University	Faculty of Management Studies	Bangalore	Karnataka	9743308892	> Business Analytics > Class room Sessions > Business Analytics in Real life >Business Analytics Software's and its Critical Use
6/5/2020 19:27:33	saranyadevim4@gmail.com	Saranya Devi M	Bengaluru Central University	Student	Bengaluru	Karnataka	9164220664	Bundle of knowledge
6/5/2020 19:27:40	vmalarvizhi@gmail.com	Dr.V.R.Malarvizhi	Excel Business School	Professor	Erode	Tamilnadu	9788635816	*Business Analytics has wider scope in future in all sectors all over the world *Faculty will use this knowledge to teach MBA students specializing in Business Analytics * Full time courses are available now in India
6/5/2020 19:27:42	nadiminty.mahesh@gmail.com	Dr.N.Mahesh	A C Patil College of Engineering, Management Studies & Research	Professor & Head	Navi Mumbai	Maharashtra	8169233857	Business analytic
6/5/2020 19:27:53	shabeenajkm@gmail.com	Shabeena j kittur	Williams international college, Bangalore	Assistant professor	Bangalore	Karnataka	9945254972	Knowledge about scope of BA. Different fields of business can be analysed using technology. Reasons for failure of business decisions. Use and importance of technology at present condition of lock down. We have lot of opportunities in BA with very good salary.
6/5/2020 19:28:00	ramyavara19@gmail.com	RAMYA GC	Vivekananda Institute Of Management	Master Of Business Administration	Bangalore	Karnataka	8217556329	It uses in Functional areas
6/5/2020 19:28:00	gowri.cims@gmail.com	D. PUSHPA GOWRI	Community Institute of Management	Assistant Professor	Bengaluru	Karnataka	9902758761	* Implications of BA in different sectors *More insight towards the subject

6/11/2020 12:10:26	surekhamrscasc@gmail.com	Dr. M. Surekha	The Oxford college of business management	Professor	Bangalore	Karnataka	8610000236	Good learning
6/13/2020 13:56:29	nila.chotai@jainuniversity.ac.in	NILA CHOTAI	CMS BUSINESS SCHOOL	Professor	Bangalore	KARNATAKA	9740535589	Learnt the Basics How Analytics is important in today's Scenario Applicability of Analytics in real time projects
6/13/2020 14:35:45	ravishankar.ulle@gssia.edu.in	Ravishankar S Ulle	GSSSIETW	Assistant Professor	Mysuru	Karnataka	9742260116	1. We know that social media and mobile commerce create a tremendous amount of data sets that contain a wealth of business and social insights. 2. When dealing with loads of data, the webinar helped me to understand the cutting edge network science research into actionable analytical strategies importance of business analytics skills through various streams of management education. 3. the webinar helped to understand to move from analysis to building strategies for future development.
6/15/2020 11:41:22	vaishnavi.kalmath02@gmail.com	Vaishnavi Basavaraj Kalmath	Colors of life	Teacher	Bangalore	Karnataka	7090026439	It was an amazing session.
6/15/2020 13:00:27	muralidharonline12@gmail.com	Prof. Muralidhar .V	Surana College	HOD - Department of Management	Surana College	Karnataka	9886553161	Business Analytics it the need of the hour and more employment opportunities are generated.
6/17/2020 12:51:11	gyestmal@pr.amity.edu	Dr. Gazala Yasmin Ashraf	Amity University Chhattisgarh	Associate Professor	Raipur	Chhattisgarh	09109923150	how business analytics will change the dimension of every sphere

6/5/2020 19:26:15	drsuni1ssac03@gmail.com	Dr Sunil Issac	Williams International College	Assistant Professor	Bengaluru	Karnataka	9110661789	*Its all takeaways with such eminent and resourceful panelists. *It has broadened the thought process itself. *It enabled me to be better prepared to deliver the good to my students.
6/5/2020 19:26:19	mushtaqbs@gmail.com	MUSHTAQ AHMAD DARZI	UNIVERSITY OF KASHMIR	PROFESSOR	SRINAGAR	JAMMU & KASHMIR	9419089086	Informative and enriching
6/5/2020 19:26:21	bhagyarastapur@gmail.com	Bhagyalakshmi.G	HKES's SLNCE,RAICHUR	ASSTS PROF	RAICHUR	KARNATAKA	9148049226	This session was very informative.It will help us in our career line.This session play a vital role in the education institutions,as resource person had gave very informative message
6/5/2020 19:26:23	saumya.singh0510@gmail.com	SAUMYA SINGH	brindavan college	assistant professor	bangalore	KARNATAKA	9836867340	gain hands on experience clarity on the practical aspects application of BA leveraging BA as an educator
6/5/2020 19:26:24	raksha.acchu12@gmail.com	Rakshana R	KLE Society S Nijalingappa College	Student	Bangalore	Karnataka	7259131858	Helped in gaining good knowledge
6/5/2020 19:26:39	mohanmourya7792@gmail.com	MOHANA C	Lorven educational centre	Lecturer	Banglore	Karnataka	8660125935	It was very informative information about business and very brief about business. And also its an easy for slow learners also thank u for organising this session.
6/5/2020 19:26:45	nraman.dr@gmail.com	Dr N . Raman	Kongu arts and science college Autonomous	Professor of commerce	Erode	Tamil Nadu	9843215319	New insight
6/5/2020 19:26:51	binduranirs00@gmail.com	Dr. Bindurani Rohidas	Sree Chaitanya Educational Institutions, Karimnagar	Associate professor	Karimnagar	Telangana	+919164495656	Application of analytics in business
6/5/2020 19:26:52	vavnish@gmail.com	Dr. Avnish Vijay	Poddar Management and Technical Campus	Associate Professor	Jaipur	Rajasthan	9413686850	*Now, I know What is business analytics. *I will be able to design a curriculum for my institute. *The idea of FasTrac has been wonderful and I believe that is the best way the students can be taught any application oriented subject. *Dr. Bung has been a motivating factor in attending this seminar. His vast knowledge in the area of Management and Business Analytics has taught me how a faculty should broaden his horizon of knowledge about a subject. *The speakers were highly effective and knowledgeable. Dr. Ramesh, Dr. Doug, Dr. Bung and *Mr. Venkatesh all were effective speakers and very well knew what is to be talked about. *Their frameworks will definitely help me in carrying forward my journey to Business Analytics. *Being a faculty of management for past 20 years and having a very good knowledge of IT will help me in developing myself in the area of business analytics.
6/5/2020 19:27:07	shanthir@kascathy.ac.in	Dr.R.Shanthi	Kaamathenu Arts and Science College, Sathyamangalam	Associate Professor	Erode	Tamilnadu	8667555064	Data Analysis tools
6/5/2020 19:27:07	ranjupk05@gmail.com	Ranjitha P K	Krupanidhi college of commerce and management, Koramangaia, Bangalore	Asst professor	BANGALORE URBAN	Karnataka	08105549070	1. Understood the importance of business analytics. 2. Understood the skills required for BA 3. The application areas of BA 4. Top 10 reasons why data analytics fail 5. The importance of data. 6. Analytics framework- fasTrac model 7. Emerging job areas in the field of BA 8. Some models and analysis
6/5/2020 19:27:09	vanisrinivas170181@gmail.com	C. Vani	Vivekananda degree college for women	Assistant professor	Bangalore	Karnataka	9945170181	

								business analytics curriculum framework *Foundation *Application *specialization Business communication Quantitative story teller Real World analytics challenge FASTRAC opportunities in analytics in Academia Moocs Swayam edtech portals internationalization of education industry viewpoints on education emerging job areas recommendations for academia 1. learning driven curriculum 2. improve facilities and infrastructure 3. building appropriate curriculum 4. ASK(attitude, skill, knowledge) 5. Learn, Unlearn, Relearn 6. Practical oriented knowledge 7. career counselling 8. engage with industry Business analytics -A Way Forward "torture the data and it will confess to anything" Ronal Coase Application of Business analytics Marketing -CRM/CEM -Customer acquisition -marketing mix -social media mkg -sentiment analysis Finance -clients profitability analytics -cash flow analytics
6/8/2020 10:10:38	suajatha@pim.ac.in	Sujatha G L	Poomaprajna Institute of Management	Assistant Professor	Udupi	Karnataka	9448796352	
6/8/2020 11:29:52	kokilan141@gmail.com	Kokila N	GRV Business Management Academy	Assistant professor	Bangalore	Karnataka	9164821303	Practical information Very informative sessions
6/8/2020 17:36:04	naziyatajs1993@gmail.com	Naziya Taj S	GRV BUSINESS MANAGEMENT ACADEMY	Assistant Professor	Bangalore	Karnataka	9972309233	Webinar helped me in enhancing knowledge in the field of BA.
6/8/2020 17:44:12	sumathy.vms@saividya.ac.in	Prof Sumathy V M S	Sai Vidya Institute of Technology	Assistant Professor	Bengaluru	Karnataka	9677542026	-Cognitive skills attained during this session -diagnostic approach
6/8/2020 19:54:04	sumathy.vms@saividya.ac.in	SUMATHY VMS	Sai Vidya Institute of Technology	Assistant Professor	Bengaluru	Karnataka	9677542026	Basic knowledge on business analytics and cognitive skills on subject
6/8/2020 20:26:14	mamathahs@gsss.edu.in	Mamatha H S	GSSS Institute of Engineering and Technology for Women	Assistant Professor	Mysuru	Karnataka	8904991206	1. Method and techniques of Business Analytics 2. How to teach and make this course easy way to understand for students. 3. Importance of Business Analytics in future
6/9/2020 6:13:52	bineshforever@gmail.com	Dr Binesh Padikkal Nair	Apex University	Professor	Bangalore	Karnataka	9740391445	Good
6/9/2020 10:44:58	veena15.mba@gmail.com	VEENA N	Williams International College	HOD	Bangalore	Karnataka	8073143446	Very Good Information
6/9/2020 11:46:21	ashwini@grvacademy.com	Ashwini Patil	GRV Business Management Academy	Assistant professor	Bangalore	Karnataka	9538173225	Very informative message about practical situation and application
6/9/2020 22:10:30	swetha.prenuka@gmail.com	Swetha MP	MLA Academy of Higher Learning	Assistant Professor	Bangalore	Karnataka	9900157529	Learned about hypothesis application Identifications of variables Importance's of literature review Learned about clear abstract writings
6/9/2020 22:55:09	Swetha.prenuka@gmail.com	Swetha MP	MLA AHL	Assistant Professor	Bengaluru	Karnataka	9900147529	Session from Industry Experts Case Study discussion from Industry Experts
6/10/2020 14:42:15	kkkgm11@yahoo.co.in	KOTHA KIRAN KUMAR	SKYBIRD AVIATION PVT LTD	LECTURER	HYDERABAD	TELENGANA	9652091440	Expose towards Business Analytics
6/10/2020 22:42:43	geetha@grvacademy.com	M Geetha	GRV BUSINESS MANAGEMENT ACADEMY	Asst. Professor	Bengaluru	Karnataka	9632198801	*Insights of business analytics *supply chain mgt *business analytics told that help companies in scaling the efficiency in their operations *applicability of BA in classroom teaching
6/11/2020 11:19:54	pavan.hsnvs@gmail.com	H S N V S PAVAN K	GOVT DEGREE COLLEGE (A) , TUNI , AP.	LECTURER IN COMMERCE	TUNI	ANDHRA PRADESH	9505993221	Many

6/5/2020 19:24:49	chandanaowda783@gmail.com	Chandana c	Vivekananda institute of management	Mba	Ramanagar	Karnataka	09535609115	* It will help future courses * Very inspirational session * Real world analytics projects
6/5/2020 19:24:49	nayanikachakraborty19@gmail.com	Nayanika Chakraborty	M.A.K.A.U.T	student	kolkata	west bengal	8697199053	VERY INFORMATIVE
6/5/2020 19:24:51	thejasvinitk@gmail.com	Thejasvi N	R V Institute of Management	Student	Bangalore	Karnataka	9738663055	NA
6/5/2020 19:24:54	biswomishra@gmail.com	BISWO RANJAN MISHRA	Utkal University	Assistant Professor COMMERCE	Bhubaneswar	Odisha	9338656870	Very informative
6/5/2020 19:24:55	mgchanmal@gmail.com	PROF. MALLIKARJUN CHANMAL	HKES Sree Veerendra Patil Degree College Bengaluru	Vice Principal and HOD of Commerce	BENGALURU	KARNATAKA	9342667137	Excellent sessions, taking away many things.
6/5/2020 19:25:06	vevangeline412@gmail.com	P. Veronica Evangaline	St Anne's degree college for women, halasuru	Assistant professor	Bangalore	Karnataka	9902157772	Data is a new oil
6/5/2020 19:25:09	sarpitha975@gmail.com	Arpitha s	RV Institute of Management	Student	Bangalore	Karnataka	9739694599	Understood career openings in analytics in future Data is new oil and how analytics can be applied in all areas without any limitations. Various tools and models of Business Analytics.
6/5/2020 19:25:10	krameshreddy2002@gmail.com	Dr. K. RAMESH REDDY	Sri Vasavi Engineering College	Associate Professor	Tadepalligudem	Andhra Pradesh	6303224104	How to improve business
6/5/2020 19:25:22	profgopi6@gmail.com	Dr. K. V. Gopinathan	Skybird Aviation College	Professor	Bangalore	Karnataka	8722660066	Got the confidence to implement in Aviation.
6/5/2020 19:25:29	shamanthkumarbu@gsss.edu.in	Shamanth Kumar B U	GSSSIETW	Assistant professor	Mysuru	Karnataka	9742701070	Got insight knowledge If University specific this subject I can easily accepted
6/5/2020 19:25:29	umar.mufeed08@gmail.com	Dr. Umar Mufeed	Cluster University Srinagar	Assistant Professor	Srinagar	Jammu and Kashmir	9541732367	* Got more insight about the application of business analytics * Provided a way forward and opportunity in application of business analytics skills in my teaching profession * A very nice opportunity for me as a faculty to get better equipped with changing education trends and demands post covid
6/5/2020 19:25:33	veervabhav@gmail.com	Vaibhav Prakash Veeragoudar	KLE Dr. M S Sheshgiri college of Engineering and Technology	Assistant Professor	BELGAUM	Karnataka	9972200334	1. Lot of Knowledge 2. The importance and future of Business Analytics 3. Good for beginners
6/5/2020 19:25:34	shamithaselvi@gmail.com	Dr R THANGA SELVI	AMBAL ARTS COLLEGE	Assistant professor of commerce	Ambasamudram	Tamil Nadu	+919444763648	Amazing knowledge Clariification Need of the hour
6/5/2020 19:25:38	swatikashyab22@gmail.com	SWATI KUMARI	RV INSTITUTE OF MANAGEMENT	STUDENT	BANAGLORE	KARNATAKA	8880311183	IT WAS A USEFUL SESSION
6/5/2020 19:25:43	manidatta.ray@bgu.ac.in	Dr. Manidatta Ray	Birla Global University (BGU), Bhubaneswar	Professor	Bhubaneswar	Odisha	9437250083	Came to know application areas of Business Analytics from Prof. Ramesh Rajagopalan's Session Prof. Doug Gray's session was also wonderful in terms of Real world applications areas of Business Analytics
6/5/2020 19:25:42	srikumar@itrm.edu	Prof Srikumar R	Institute for Technology and Management, Bangalore	Campus Head	Bangalore	Karnataka	9886745979	Excellent presentation & Business Analytics scope for teaching covered
6/5/2020 19:25:45	sowjanyaabhatb1997@gmail.com	Sowjanya Bhat B	R V Institute of Management	Student	Bangalore	Karnataka	8970115118	Business analytics in education and industry play a vital role.
6/5/2020 19:25:57	aakanksha102bs@gmail.com	Aakanksha Rao B.S	RVIM	STUDENT	Bagalore	Karnataka	09845723945	Very much useful
6/5/2020 19:25:59	rayyanriz2013@gmail.com	Rizwana Khanum	Al Ameen Institute Of Management Studies	Faculty MBA	Bangalore	Karnataka	9900398192	Good
6/5/2020 19:26:06	sushobhananand@gmail.com	SUSHOBHAN ANAND	SACHCHIDANAND SINHA COLLEGE	ASSISTANT PROFESSOR	AURANGABAD	BIHAR	9971220644	* I got the idea regarding the Business analytics. * How Business analytics can be used in your learnings well as teaching career
6/5/2020 19:26:11	n.chaitra14@gmail.com	Chaitra.N	Vivekananda Institute of Management	Student	Bangalore	Karnataka	7975847395	Knowledge about the business analytics

6/7/2020 8:12:28	sanjeeva248044@gmail.com	SMITHA. L	Government First Grade College for Women.	Assistant Professor of Commerce.	Tumkur	Karnataka	9731098060	Awareness about Business Analytics. Business Models.
6/7/2020 8:18:17	mavericknadir@gmail.com	Nasir Yaseen Khanday	Central University of Kashmir	Research Scholar	Anantnag	Jammu & Kashmir	9797092066	The broad understanding of business analytics and its utilization in modern teaching world. Which is becoming more and more imperative day by day.
6/7/2020 8:19:46	swatishki94@gmail.com	Swati Shukla	S.R. group of institutions	Ex. Assistant Professor	Lucknow	Uttar pradesh	7355073476	To know about various aspect about Business Analytics
6/7/2020 9:35:10	naginamali2012@gmail.com	Dr.Nagina Subhash Mali	Department of Education, Shivaji University, Kolhapur	Assistant Professor	Kolhapur	Maharashtra	8975295297	I am entering in business section so that this programme increased my confidence
6/7/2020 10:11:56	pavi8128@gmail.com	Pavan cs	Vevikananda college Bangalore	CA	Tumkur	Karnataka	7892247074	Understand the business analyst and how its work acquireing more knowledge about business analyst
6/7/2020 11:55:14	madhubm.app@gmail.com	Madhu B M	Hewlett-Packard Enterprise	Analytics Consultant	Bangalore	Karnataka	9035603080	Analytics for business Analytics in day to day life Limitation of analytics
6/7/2020 13:40:33	seema@claretcollege.edu.in	SEEMA JOSEPH	St.Claret College	Assistant Professor	Bangalore	Karnataka	9742218991	* Better understanding about the Business Analytics * Learned about the opportunities available in the field * Learned about the resources available to enhance learning in the topic
6/7/2020 14:50:19	divyas2630@gmail.com	DIVYA.S	VIJAYA EVENING COLLEGE	ASSISTANT PROFESSOR	BANGLORE	KARNATAKA	9902943356	insight business performance can be measured....lot of case studies helps
6/7/2020 15:41:56	sheetal.m@isbr.in	Sheetal Mahendher	ISBR Business School	Associate Professor	Bangalore	Karnataka	9886109690	The points on data analytics explained well with live case studies and to know how the most important point is to identify the problem first
6/7/2020 16:43:49	raogreeshma012@gmail.com	Greeshma Rao	RVIM	HR	Bangalore	Karnataka	9742708452	- The webinar was more insightful and informative session. - Dr. Bung explained what is business analytics and what are the implementation using it, this gave me basics of BA. - Dr. Ramesh also introduced to the topic and methods of using BA. - Dr. Doug explained the application of business analytics in the real world of business which helped me know what is expectations and challenges in BA projects. - Dr. Venkatesh showed us the repositories of BA and industry perspective. - In education perspective, what skills I need have and improve myself to work on BA. - There is a gap in supply and demand of skills. - Case studies are explained such that we are aware of implications and outcomes with challenges. - Exposure on various applications of BA in different field. - The dynamic change of trends in BA real world.
6/7/2020 17:49:23	dayanandhodan19@gmail.com	Prof.Dayanand .D .Hodal	S . B . College of . Commerce, Kalaburgi .	Principal	Kalaburgi.	Karnataka	9980387019	New enterprenuers creating is big problem . This type of webinars are helping solve above said.
6/7/2020 19:28:58	roopatemkar@gmail.com	Dr. Roopa Temkar V	SJBIT	Associate Professor	Bangalore	Karnataka	9449545150	Good information leamt the applications of business analytics

6/5/2020 19:23:19	karnati.saketh@gmail.com	KARNATI SAKETH REDDY	Rajiv Gandhi University of Knowledge Technologies, R K Valley, Andhra Pradesh	Faculty	Kadapa	Andhra Pradesh	9482193829	Insights about the industry Business analytics applications case studies
6/5/2020 19:23:25	lakshmisk74@gmail.com	LAKSHMI S K	C B Bhandari jain college	Assistant professor	Bangalore	Karnataka	9980769028	Got insight into role and importance of business analytics There is a large scope for including BA in all the fields including education sector
6/5/2020 19:23:26	divya_compscience@indianacademy.edu.in	Dr.Divya Kashyap	Indian Academy Degree College Autonomous	Assistant Professor	Bangalor	Karnataka	08197638888	1. got the knowledge at BI at international level 2. most important Data is oil now. its a source of making huge money 3. All the business area, like eductaion, medical, finance, HR etc , analytics is everywhere now
6/5/2020 19:23:33	komalatha.b.c@gmail.com	KOMALATHA B C	V V N DEGREE COLLEGE	Assistant Professor	Bengaluru	Karnataka	9901712570	Information
6/5/2020 19:23:36	abass.ashoor.bhat788@gmail.com	Dr Mohd Abass Bhat	Assosa University	Assistant Professor	Assosa	Ethiopia	+917889873545	This is need of today learning but our institution are yet working on traditional course.
6/5/2020 19:23:37	akshaystar001@gmail.com	Akshay Kumar Av	Jain Evening College, Vasavi Campus	Proffesor	Bangalore	Karnataka	+19535329142	Clearly explained about all the aspects involved in Business analytics. Enlightened on the importance and future in Business analytics
6/5/2020 19:23:49	mohdshaikhulashraf@gmail.com	DR. MOHD. SHAIKHUL ASHRAF	HKM GOVT. DEGREE COLLEGE BANDIPORA	SENIOR ASSISTANT PROFESSOR (BOTANY)	BANDIPORA	JAMMU AND KASHMIR	7889729404	Learned about various current issues of business and education.
6/5/2020 19:23:58	shetti.chetan@gmail.com	Chetan Shetty	Global Academy of Technology	Assistant Professor	Bangalore	Karnataka	9738355979	Very informative
6/5/2020 19:24:00	rajiselvan.66@gmail.com	Dr.C.RAJALAKSHMI	Devanga Arts college, Aruppukottai	Assistant professor in commerce ,Aruppukottai	Aruppukottai	Tamil Nadu	9944070061	Got the knowledge about business analytics
6/5/2020 19:24:00	meghana.nanu007@gmail.com	Meghana Nanaiah K	International School for Business Research	Research Scholar	Bangalore	Karnataka	8550075861	I had no idea about Business Analytics but after attending the webinar conducted by your esteemed institution I was able to understand and gained lot of knowledge regarding BA. I hearty thank the organizers for such wonderful session and I look forward for more from your esteemed institution. Lastly, very well hosted by Prof. Priya Jain.
6/5/2020 19:24:02	sri.pulikam@gmail.com	P. GIRIJASRI	QIS College of Engineering and Technology	Assistant Professor	Ongole	Andhra Pradesh	7416446463	1. Importance of business analytics 2. Difficulties of business analytics 3. Advantages of business analytics 4. Trends in business operations by using business analytics
6/5/2020 19:24:04	nagarjuna1975@gmail.com	Dr.B.NAGARJUNA	Sree Vidyanikethan Institute of Management	Associate Professor	Tirupati	Andhra Pradesh	9885462950	1) Understood the basics of Business Analytics 2) Got Clarity on what Business Analytics is all about
6/5/2020 19:24:10	bns.ishere@gmail.com	Brahmmanand Sharma	Prestige Institute of Management, Gwalior	Assistant Professor	Morena	Madhya Pradesh	7827704208	Sector wise key trends, Business analytics landscape, Application of Analytics, Business analytics in academia, Business analytics Skills, Online resources , Case studies and Industry View points
6/5/2020 19:24:16	naraharis@rvce.edu.in	N S NARAHARI	RV college of engineering	Professor	Bangalore	Karnataka	9880311128	Fastrac
6/5/2020 19:24:23	deekshagowda181@gmail.com	DEEKSHITHA R	VIVEKANANDA INSTITUTE OF MANAGEMENT	Master of Business Adminstration	Bangalore	Karnataka	8095674887	The Data is the oil we have to create a oil nd data to the inputs of the business analytics it will useful for the analysts to the programming courses nd it will help in the functional areas it will be speeding up the techniques in the present nd future senerio data is the information which help to the Management students
6/5/2020 19:24:26	venkatnarayanaraot@sreenidhi.edu.in	Dr.T.Venkat Narayana Rao	Sreenidhi institute of science and technology	Professor	Hyderabad	Telangana	+919849112253	Over view of business analytics
6/5/2020 19:24:31	shankar2171@gmail.com	SHANKARACHARYA	VIJAYA BIFURCATED PU COLLEGE	HOD - ASSOCIATE PROFESSOR	BANGALORE	KARNATAKA	9448762080	Real Energy Boost for Academicians. Thought provoking base for creating career based Edu. Given a platform to create new such curriculum for future generations.
6/5/2020 19:24:36	shashi.mag@gmail.com	SHASHIKUMAR C R	SJB INSTITUTE OF TECHNOLOGY	Assistant Professor	Bangalore	Karnataka	9449794337	Advantage of BA Scope of BA

6/6/2020 19:37:10	keshavrokna98@gmail.com	Keshav Kumar Rokna	Adesh Medical college	Student	Sri Ganganagar	Rajasthan	7976739410	It's realistic things which helps alot
6/6/2020 19:40:46	kajalmiglani046@gmail.com	Kajal miglani	D.a.v college	Student	Sriganganagar	Rajasthan	9649203489	Very informative
6/6/2020 23:01:31	priyajakhar0207@gmail.com	PRIYA JAIN	RVIM	ASSISTANT PROFESSOR	BANGALROE	Karnataka	09108300728	LEARNING
6/6/2020 23:03:35	praphulla.sunil037@gmail.com	Praphulla Chandra N	Davangere University	Research scholar	Bangalore	Karnataka	7760093464	It was really gud , I should get hands on it .
6/6/2020 23:12:36	priyajakhar0207@gmail.com	priya	rv	ap	bangalore	Karnataka	09108300728	learning
6/6/2020 23:12:39	arpithabs1996@gmail.com	Arpitha B S	VVN Degree College	Assistant Professor	Bengaluru	Karnataka	9739826112	Briefing about the importance of business analytics and implementation in industries and educational institutions.
6/6/2020 23:17:28	pps1008@gmail.com	Pawan Pramod Sharma	Pragnya Education & Skill Development Centre Vijayapur	Consultant	Vijayapur	Karnataka	974321256	It is not the models you build but the business actions they translate to that create your impact as a data professional. Business actions are not something you can create and focus on alone. They require collaboration and understanding of the business. Learned about How to move from analysis to decisions, and from decisions to strategy within organization.
6/6/2020 23:18:57	aadyasu@gmail.com	SUSHMA A R	Government First Grade College, Yelahanka, Bangalore	Assistant Professor	Bangalore	Karnataka	9986692705	It was a good a session
6/6/2020 23:21:28	namrata.deshpande3@gmail.com	Namrata Deshpande	Pragnya Education & Skill Development Centre Vijayapur	Consultant	Vijayapur	Karnataka	9743231256	Big Data presents enormous opportunity for business. Volume, velocity, and variety define the challenges of Big Data Decision-making is data-driven. Evidence drives decisions, not intuition. Using personal customer information can have negative consequences. Don't spy. Respect people's privacy. Learned about How to move from analysis to decisions, and from decisions to strategy within organization.
6/6/2020 23:25:48	ankitasajjan@gmail.com	Dr. Ankita Sajjan	University Of Lucknow	Subject Expert	Lucknow	Uttar Pradesh	9628606551	challenges in bringing analytics in academics and Reason behind data science projects failure
6/6/2020 23:27:32	mmeerababu@gmail.com	Dr.Meera.B	SJR college	HOD department of Business analysis	Bangalore	Karnataka	9916875501	Practical approach Concept clarity Various models
6/6/2020 23:29:02	sheetal.m@isbr.in	Sheetal Mahendher	ISBR Business School	Associate Professor	Bangalore	Karnataka	9886109690	The points on data analytics explained well with live case studies and to know how the most important point is to identify the problem first
6/6/2020 23:36:34	vanathinaveen@gmail.com	VANATHI	Bangalore University University	Assistant professor	Bangalore	Karnataka	9945786731	It more helpful to design date Knowledge of business analytics need for project so in that aspect it was useful. the subject is interrelated to managerial as well business economics so got some idea how to interpret the data Thank you
6/6/2020 23:40:16	anitabsomanna@gmail.com	ANITA B.S.	PVP FIRST GRADE COLLEGE	Associaye Professor	BANGALORE	KARNATAKA	7624990843	Gained much knowledge and applications of BA ,which I can add on to enter my teaching, thank u
6/7/2020 1:54:29	sowmya.suresh92@gmail.com	Sowmya. S	A. M. S Composite PU College	Lecturer	Bangalore	Karnataka	9880642205	A few key points that are brainstorming and worth to be implied in my institution if given a chance
6/7/2020 7:09:07	dr.periasamy_p@cms.ac.in	Dr.Periasamy P	CMSBSchool Jain Deemed to be University	Associate professor	Bengalore	Karnataka	9894994989	So many
6/7/2020 7:41:49	Profgopi6@gmail.com	Dr. Gopinath, K. V.	Skybird Aviation College	Professor	Bangalore	Karnataka	8722660066	Excellent presentation
6/7/2020 7:46:12	raju08.r@gmail.com	Nagaraju R	REVA UNIVERSITY	Assistant Professor	Bangalore	Karnataka	9591671206	Importance , Determinants and Application of Business Analytics
6/7/2020 7:56:48	ashokgowri17@gmail.com	M. L. ASHOK	Seshadripuram First Grade College	Associate Professor	Bengaluru	Karnataka	9844039924	Wonderful webinar from the expertise from the field Planning to introduce BDA in our Institution at under graduate level

6/5/2020 19:22:17	deepagshankar17@gmail.com	Deepa G	Thomson Reuters	Research analysts	Bangalore	KArnataka	7411901914	Introduction to BA How it works in educational institutions How to apply it in real project Different ideas to adopt it Avoiding its failures
6/5/2020 19:22:22	shesha51@hotmail.com	Dr Y V Sheshadri	Al Ameen Institute of Management Studies	Associate professor	Bangalore	Karnataka	9900655591	Examples Case study
6/5/2020 19:22:23	psupradeep76@gmail.com	SUMALATHA G	Vivekananda institute of management	MBA	Bangalore	Karnataka	9620391611	It's very useful for my future life
6/5/2020 19:22:34	mokshagundam89@gmail.com	Dr. S SRIRANJANI MOKSHAGUNDAM	HILLSIDE INSTITUTE OF MANAGEMENT AND ACADEMY, BANGALORE	PRINCIPAL	BANGALORE	KARNATAKA	8884552311	Deeper knowledge on Business Analytics
6/5/2020 19:22:36	srivallisrivalli7@gmail.com	Dr.Srivalli Jandhyala	Mallareddy institute of management	Associate professor	Hyderabad	Telangana	9381262426	* Firstly I learnt that business analytics is not a subject it is a practice what we have to apply in the real time environment . *Business analytics always needs continuous application and guidance of some expertise.
6/5/2020 19:22:38	mounicapv1997@gmail.com	P.V. Mounica	Community institute of management studies	Student	Bangalore	Karnataka	9741850881	Informative session about business analytics
6/5/2020 19:22:38	naginamali2012@gmail.com	Dr.Nagina Subhash Mali	Department of Education, Shivaji university, Kolhapur	Assistant Professor	Kolhapur	Maharashtra	8975295297	Learnt more valuable information about the business
6/5/2020 19:22:40	sharadashanky@gmail.com	Dr. Sharadha.S	AleMS	Professor	Bidadi	Karnataka	9341978182	This webinar gave a very clear understanding of business analytics, utility and also the future of BA
6/5/2020 19:22:41	shamithaselvi@gmail.com	Dr R THANGA SELVI	AMBALI ARTS COLLEGE	Assistant professor of commerce	AMBASAMUDRAM	Tamil Nadu	+919444763648	♥️ <input type="checkbox"/> Amazing knowledge ♥️ <input type="checkbox"/> Learned new things ♥️ <input type="checkbox"/> Need of the hour ♥️ <input type="checkbox"/> Well chosen of topic ♥️ <input type="checkbox"/> Resources shared by resource persons ♥️ <input type="checkbox"/> @ Lockdown which is not name sake webinar ♥️ <input type="checkbox"/> Clarity of unknown area through queriesThank you.....
6/5/2020 19:22:44	mahalakshmia375@gmail.com	Mahalakshmi A	Vivekananda institute of management	Student	Bangalore	Karnataka	9380068014	Really it's helpful for my career& I learned lot, what are the skill we have to become a n business analyst
6/5/2020 19:22:46	ravindraoudepts@gmail.com	RAVINDRA REDDY M	OSMANIA UNIVERSITY	MEDICAL PSYCHIATRIC SOCIAL WORK	HYDERABAD	TELANGANA	9705503767	INSIGHTS INTO BA
6/5/2020 19:22:46	krishnamishra84@gmail.com	Dr Krishna Narayan Mishra	Rajiv Gandhi South Campus, BHU	Assistant Professor	Mirzapur	UP	9425321255	New ways of teaching students and providing new and effective way of doing BA
6/5/2020 19:22:48	clintan_r@outlook.com	Clintan Joyan Roche	R. V. Institute Of Management	Student	Bangalore	Karnataka	9844630217	Understood how useful business analytics in the real world.
6/5/2020 19:22:50	mary.monica2801@gmail.com	Mary Monica R	KPMG	Audit Associate	Banglore	Karnataka	9738777558	The session was very informative 1. Understood Business analytics 2. Had a great knowledge how it works in US. 3. understood the tools
6/5/2020 19:22:54	manjunathsk.rvim@rvei.edu.in	MANJUNATH S K	RV Institute of Management	Assistant Professor & PRO	Bangalore	Karnataka	9945578825	Introduction to world of Analytics
6/5/2020 19:22:55	grathore82@gmail.com	gagan rathore	choithram college of professional studies	asst. professor	indore	madhya pradesh	9755360659	dung sir session
6/5/2020 19:22:56	savita@bideaspcc.ac.in	Dr. Savita Kulkarni	BLDEA'S ASP College of Commerce (A) MBA Program Vijayapur	professor & Director	Vijayapur	Karnataka	9900266995	Understanding BA .. BA Application in functions of management..
6/5/2020 19:22:58	pkpkthakur@gmail.com	PURUSHOTTAM KUMAR	AIMSR	ASST. PROFESSOR	BANGALORE	KARNATAKA	9591042016	* DATA IS NEW OIL
6/5/2020 19:23:00	praveenhc7@gmail.com	PRAVEEN KUMAR H C	Vivekananda Institute of management studies	MBA	Bangalore	Karnataka	9591101079	1. Useful information 2. Skills about business analytics
6/5/2020 19:23:04	lakshmiPriya.gat@gmail.com	LakshmiPriya M C	SJB Institute of Technology	Assistant Professor	Bangalore	India	+918073260125	Insights about applications of BA
6/5/2020 19:23:09	rambabusujj@gmail.com	DR S PACKIALAKSHMI	Devanga Arts College	Assistant Professor of Commerce	Aruppukottai	Tamilnadu	9894446246	Business Analysis Methods
6/5/2020 19:23:17	meenakshikouta99@gmail.com	Kouta Meenakshi Mrudalashree	Malla Reddy Engineering College For Women	Student	Secunderabad	Telangana	9701779900	Application in real world

6/5/2020 19:47:48	ashutoshpaturkar@gmail.com	Dr. Ashutosh A. Paturkar	Dr. Ambedkar Institute of Management Studies & Research	Professor	Nagpur	Maharashtra	8983626024	<ol style="list-style-type: none"> 1. What to avoid while working on data science projects 2. Potential for business analytics in Management (Marketing, HR, Finance, Production, CRM) 3. Business analytics skills like - identifying sources of data, identifying modeling techniques, model building, interpret model results etc 4. Developing business analytics curriculum frameworks - Foundation, Application, Specialization, quantitative story telling 5. Scope of Business Analytics: Descriptive, Predictive, Prescriptive and Cognitive
6/5/2020 19:48:32	zsmulla63@gmail.com	Dr. Zameer Ahmed S Mulla	R. M.Dhariwsi Sinhgad Management School Kondhpuri Pune	Professor	Pune	Maharashtra	9822406631	<p>Business Analytics is necessary in all walks of life in business. It boosts and help Decision making process. It also supports management for making strategies. Data availability and quality data make analytics successful. There are lot of tools available in the market. Even open source tools also available. Tools selection for the Data Analytics is important Decision for clients prospective and industry prospective</p>
6/6/2020 15:23:35	prakash.eco9@gmail.com	Mr.Prakash Chougala	SPM SGS Arts and Comm.College, Madabhavi	Principal	Madabhavi, Athani	Karnataka	9945125378	<ul style="list-style-type: none"> * It provided sufficient information about education and business analysis * This helped me a lot while sharing my ideas to the students * It clarified various doubts of mine, specifically the future of education and learning process.
6/6/2020 15:35:53	shakkee.smk@gmail.com	SHAKEELA.M.K.	SIVANANDA SARMA MEMORIAL R V COLLEGE	ASSISTANT PROFESSOR	BANGALORE	KARNATAKA	9742338289	Need to be explorative, investigative in performing business to deal in future competitive world.
6/6/2020 15:49:31	mrsanjayrastogi@gmail.com	DR. SANJAY KUMAR RASTOGI	HINDU COLLEGE MORADABAD	ASSOCIATE PROFESSOR	MORADABAD	UTTAR PRADESH	9412634377	ACQUIRED SOME KNOWLEDGE ABOUT BUSINESS ANALYTICS
6/6/2020 15:52:39	mahalakshmiavi@gmail.com	Dr.A.MAHALAKSHMI	M S Ramaiah Institute of Technology	Associate Professor	Bangalore	Karnataka	8150044327	<ul style="list-style-type: none"> * Increasing placement opportunities for students * Consultancy opportunities * Help in getting good marks in Accreditation
6/6/2020 16:20:36	geevarathna@gmail.com	Dr.Geevarathna	Acharya Bangalore B School	Associate Professor	Bangalore	Karnataka	9986738666	<p>Learned about Significance of BA Where and how to look for opportunities in BA Business relevance of BA in coming days</p>
6/6/2020 16:36:24	udayravi9urk@gmail.com	UdayaRaviKanth KV	RV INSTITUTE OF MANAGEMENT	MBA	Bangalore	Karnataka	9663585736	<ol style="list-style-type: none"> 1.Data has been called many things such as the new oil and the new electricity, but, it is really the new capital, on a par with financial and human capital for creating new products and services. 2.In order to harness the power of their data, businesses need a solid strategy that incorporates everything from security to data governance to choosing the right technologies. 3.Organizations that embrace digital transformation will succeed. 4.Putting data to use must be accomplished now in a day, or at most a week. The reason data science is critical now. 5.Big data requires a mix of technologies. There are more options than ever for data management, including relational, columnar, and in-memory.
6/6/2020 16:40:33	hanishatadavarthy98@gmail.com	Hanisha Tadavarthy	R V INSTITUTE OF MANAGEMENT	Student	Banglore	Karnataka	8867119968	It was interesting session
6/6/2020 16:41:56	rakhenduk52507@gmail.com	Rakhendu Kanakvidu	R V Institute Of Management	Student and ATD Certified Trainer	Kalaburagi	Karnataka	9739466338	Be creative with data
6/6/2020 16:47:32	salu2230@gmail.com	Salman pasha	R.V.Institute of management	Student	Bangalore	Karnataka	8618774474	Scope of business analytics, business analytics has become essential for every business organisation
6/6/2020 18:54:29	raksha.acchu12@gmail.com	Rakshana R	KLE Society's S Nijalingappa College	Student	Bangalore	Karnataka	7259131858	Good knowledge

6/5/2020 19:20:19	ashima.garg17@gmail.com	Ashima Garg	Maharishi Markandeshwar (Deemed to be University)	Assistant Professor	Ambala	Haryana	8053238178	*Process of analyzing raw data. *This process begins with descriptive analytics. *The next essential part is advanced analytics.
6/5/2020 19:20:25	grmane@git.edu	Govindraj R Mane	KLS Gogte Institute of Technology	Assistant Professor	Belagavi	Karnataka	9449751007	Use of Business analytics in more effective manner
6/5/2020 19:20:28	rkkv22@gmail.com	K V Ravi Kiran	Virtual Congruence	Consultant	Hyderabad	Telangana	9908954000	Insights for practical applications
6/5/2020 19:20:34	saradhivr@gmail.com	Chenna Pardha Saradhi	Swamy vivekananda engineering college	Professor	Bobbili	Andhra Pradesh	8074807048	Good
6/5/2020 19:20:35	vanisrinivas170181@gmail.com	C. Vani	Vivekananda degree college for women	Assistant professor	Bangalore	Karnataka	9945170181	Very nice n informative session
6/5/2020 19:20:42	km.mahesh@jaincollege.ac.in	Prof.K.M.MAHESH	SBMJAIN EVENING COLLEGE VVPURAM BANGALORE	PRINCIPAL	Bangalore	Karnataka	9844542284	Fastrac
6/5/2020 19:20:45	guru.bsk@gmail.com	Bala Sendhil Kumar G	Kristu Jayanti College	Associate Professor	Bengaluru	Karnataka	9994479492	Both sides of BA
6/5/2020 19:20:46	sfatimafarhat@gmail.com	S Fatima Farhat	Williams International College	Assistant Professor	Bangalore	Karnataka	9751922554	Data is Oil
6/5/2020 19:20:48	bharath.bc7@gmail.com	BHARATH C	Seshadripuram College	ASSISTANT PROFESSOR	Bangalore	Karnataka	8880333834	Score of THE COURSE APPLICATION OF BA IN VARIOUS FIELDS
6/5/2020 19:20:57	kalyan9suman@gmail.com	A. SUMAN KALYAN	Dr. K.V. SUBBA REDDY INSTITUTE OF MANAGEMENT	Assistant Professor	KURNOOL	ANDHRA PRADESH	9440297746	Thank you for enlightening me on the prospects of Analytics. The dearth of analysts and what we can do to reap the benefits.
6/5/2020 19:21:04	regimoses@yahoo.com	Lily Regina Arthi S	St.Anne's Degree College for Women, Halasuru, Bengaluru	Assistant Professor	Bangalore	Karnataka	9880855994	Importance of Business Analytics in Business Future of Business
6/5/2020 19:21:06	suman.pm25@rediffmail.com	Dr. Suman P M	Vivekananda institute of Management	Assistant Professor	Bangaluru	Karnataka	9844589629	knowledge
6/5/2020 19:21:12	mahesh.kumv@gmail.com	MAHESH KUMAR V	BENGALURU CENTRAL UNIVERSITY	FACULTY-TOURISM STUDIES	BENGALURU	KARNATAKA	9482250073	PLAN TO TAKEUP A COURSE IN BAJAI
6/5/2020 19:21:20	ibharani2006@gmail.com	Ibha Rani	SSR College of Science and Management Studies	Assistant professor	Bangalore	Karnataka	8095046008	i am naïve in BA Area . i am always interested to learn new things .from this webinar i learn few things and got the motivation to learn more things ..
6/5/2020 19:21:22	kushwaha.hemant2@gmail.com	HEMANT KUSHWAHA	Shri Mata Vaishno Devi University	Research Scholar	Jammu	Jammu and Kashmir	9582799571	Use of business analytics to build model and solve problems smartly
6/5/2020 19:21:23	shanu28sourabh@gmail.com	MR. SOURABH KUMAR	VEER KUNWAR SINGH UNIVERSITY, ARA, BIHAR.	PH.D RESEARCH SCHOLAR	KATIHAR	BIHAR	9097919625	The webinar was quite impressive!! This webinar leads us to understand many new things to implement in the real and fast world. The presentation and the way of elaborating the slides was impressive and leads us to understand the things very clearly.. All the penalist was extra ordinarily personalities. Everything was more than fine in this webinar.....
6/5/2020 19:21:23	manjurajaras8493@gmail.com	Manju D	Aps college of commerce	Assistent professor	Bangalore	Karnataka	7899358894	Knowledge and application of business analytics
6/5/2020 19:21:26	kiranskakade1@gmail.com	Dr Kiran Shrimant Kakade	Guru Nanak Institute of Management Studies, Mumbai	Assistant Professor	Mumbai	Maharashtra	7021191335	Analytics in Academia Scope of BA
6/5/2020 19:21:43	hm.nethra28@gmail.com	NETHRA H M	SESHADRI PURAM FIRST GRADE COLLEGE	ASSISTANT PROFESSOR	BANGALORE	KARNATAKA	9886175946	KNOWLEDGEABLE INFORMATION
6/5/2020 19:21:45	drmadhus73@gmail.com	Dr. Madhu S	The National College	Professor	Bangalore	Karnataka	9448082504	Knowledge Enrichment
6/5/2020 19:21:50	sunilry@rvce.edu.in	Sunil Yalamalle	R V College of Engineering	Assistant professor	Bengaluru	Karnataka	9663797527	Nice knowledge in this area
6/5/2020 19:21:56	jyothi.koutha@gmail.com	K. Shree Jyothi	St Francis College for Women	Assistant Professor	Hyderabad	Telangana	8978694000	Scope for Analysts
6/5/2020 19:21:57	drnsireesha.iimb@gmail.com	Dr. Sireesha Nanduri	JAIN	Assistant Professor	Bangalore	Karnataka	9972129378	Insights Scope of BA
6/5/2020 19:22:05	itzsuryaaa@gmail.com	K SURESH KUMAR	S D College of Information Technology	HOD	TANUKU	ANDHRA PRADESH	9581655757	Technology Advancement
6/5/2020 19:22:05	131449gunjan@gmail.com	Gunjan Raj	R.V.INSTITUTE OF MANAGEMENT	STUDENT	BANGALORE	KARNATAKA	7991143715	1. Got good knowledge about business Analytics 2. Knowing new sector of Analytics

6/5/2020 19:35:00	vallabh.mahale@jyothyit.ac.iny	VALLABH MAHALE	Jyothi Institute of Technology	Assistant Professor	Bengaluru	Karnataka	9035611021	Knowledge of Business Analytics
6/5/2020 19:35:14	bhanuvishwa@gmail.com	Bhanumathi T.V.S	St.Annes Degree College for women, Halasuru	Assistant Professor	Bangalore	Karnataka	8951043343	Data is a new oil
6/5/2020 19:35:20	shravanichelle@gmail.com	CHELLE SHRAVANI	VKR,VNB & AGK COLLEGE OF ENGINEERING	ASSISTANT PROFESSOR	GUDIVADA	ANDHRA PRADESH	7013945519	Excellent webinar
6/5/2020 19:36:02	mukkapatinarendra9@gmail.com	MUKKAPATI NARENDRA	V.K.R, V.N.B & A.G.K COLLEGE OF ENGINEERING	ASSISTANT PROFESSOR	GUDIVADA	ANDHRA PRADESH	7702727108	Realtime business analytics
6/5/2020 19:36:46	mailgiridhar.r@gmail.com	GIRIDHAR RAJAGOPAL	RJS INSTITUTE OF MANAGEMENT STUDIES	Assistant Professor and Training and Placement I/c	BANGALORE	KARNATAKA	9972642772	<ol style="list-style-type: none"> 1. It was application based. 2. BA appeared achievable other wise I thought it to some sort of rocket science. 3. My fear towards Business analytics modelling has turned into a curiosity. 4. I do understand BA holds great importance in higher education in future
6/5/2020 19:36:50	7karthik.m@gmail.com	Karthik M	RV Institute of Management	Student	Bengaluru	Karnataka	9900741401	<p>Business analytics is data-driven decision making process to solve business problems and improve efficiency. It has practical applications with statistical tools.</p> <p>Top reasons for failure data science project and solutions to overcome them</p> <ol style="list-style-type: none"> 1. Not understanding real business problem 2. Data issue 3. Misapplying the model 4. Solving inappropriate business problem 5. Communication mismatch 6. Not adopting change management 7. Unrealistic expectation 8. Inefficient project management 9. Excessive focus on model, technique that aren't much important 10. Sandbox to production system error 11. Not being empathic <p>Case study on propensity model, BA skills & roles. Industry point of views</p>
6/5/2020 19:37:50	deepakranjan.cuharyana@gmail.com	Deepak Ranjan	Central University of Haryana, Mahendragarh	student	Mahendragarh	Haryana	9354605475	How to use data to extract meaning ful information? how to solve real world problems with the help of data? how to make career in the field of data science and usage of open sources?
6/5/2020 19:38:16	shreeshar32@gmail.com	Shreeshar.R	CBSMS, Bangalore University	Student	Bangalore	Karnataka	8553311164	Effective presentation Beautiful insights on the future of analytics industry
6/5/2020 19:40:46	prof.ssn@iibsonline.com	Swati Sen	International Institute of Business Studies	Assistant Professor	Bangalore	Karnataka	9836052040	<ol style="list-style-type: none"> 1. Real world analytical examples, 2. Understanding on how to portray real life business analytics case study to students, 3. Knowing about renowned Business Analytics books to refer and learn, 4. Understanding the applications of business analytics in different industry sector, 5. Identifying the right Business Analytics models for appropriate usage, 6. Understanding the applications related each type of Business Analytics.
6/5/2020 19:41:50	luckeykunigal@gmail.com	LAKSHMAN C	VIVEKANANDA INSTITUTE OF MANAGEMENT	MASTER OF BUSINESS MANAGEMENT	Bangalore	Karnataka	8095674887	It's interesting
6/5/2020 19:42:46	shalu.kotwani@gmail.com	DrShalu Kotwani	Shri Vaishnav Institute of management Indore	Assistant professor	Indore	Madhya pradesh	8319966428	Applicability of business analytics in different sectors Scope of business analytics in future
6/5/2020 19:43:34	sandeepkulkarni598@gmail.com	Sandeep kulkarni	kis gogte institute of technology	Gulbarga	Belagavi	Karnataka	09591163360	Good

6/5/2020 19:19:08	nishithabatchu@gmail.com	N.V.SUSHMITHA.S	VKR, VNB & AGK COLLEGE OF ENGINEERING	Assistant professor	Gudivada	Andhra Pradesh	9030877137	Deep insight into business analytics
6/5/2020 19:19:08	shailaja.budur@gmail.com	Dr. SHAILAJA B	ALLUM KARIBASAPPA INSTITUTE OF MANAGEMENT	ASSOCIATE PROFESSOR	BALLARI	KARNATAKA	9553009706	Knowledge
6/5/2020 19:19:17	moirangthem.roshini@gmail.com	Dr. Moirangthem Roshini	Manipur Technical University	Assistant Professor	Imphal	Manipur	9856317429	Increase my knowledge on BA
6/5/2020 19:19:23	meghnagoyal92@gmail.com	Meghna Goyal	Gautam Buddha University	Research Scholar	Delhi	Delhi	9467836126	Informative
6/5/2020 19:19:27	sarithasjeevaromal@gmail.com	Dr. P. Saritha kumari	Sree Devi kumari Women's college	Head and Assistant Professor of PG Commerce	Kanyakumari	Tamil Nadu	9785969284	Enhancing knowledge
6/5/2020 19:19:28	anandherode@gmail.com	MURUGANANDHAM S	Erode Arts and Science College (Autonomous)	Assistant Professor	Erode	Tamil Nadu	9486763902	Idea of offering Business Analytics course
6/5/2020 19:19:29	huma.lone@suryadatta.edu.in	Dr. Huma Lone	Suryadatta Institute	Assistant Professor	Pune	Maharashtra	9881735821	Overall Secerio for Busienss analytics, interesting cases
6/5/2020 19:19:29	chandans904@gmail.com	Mr chandan Kumar Singh	Sachchidanand Sinha college Aurangabad	Assistant professor	Aurangabad Bihar	Bihar	9060429078	Knowledge about business analyst
6/5/2020 19:19:30	prayaggokhale07@gmail.com	PRAYAG P. GOKHALE	KLE DR. MSSCET, Belgaum	Asst. Prof.	BELGAUM	KARNATAKA	9844978991	Insights on future of Business Analytics
6/5/2020 19:19:30	madhavan1000jj@gmail.com	Dr.R.Sethumadhavan	Dayananda Sagar college of engineering	Faculty	Bangalore	Karnataka	9486220268	Good information
6/5/2020 19:19:39	s.tabassumsultana@gmail.com	Dr. Syed Tabassum Sultana	Matrusri Institute of Post Graduate Studies	Professor	Hyderabad	Telangana	9885587895	Got fair amount of overview of BA
6/5/2020 19:19:44	chinmayaofficial95@gmail.com	CHINMAYA KUMAR SAHOO	RAVENSHAW UNIVERSITY,CUTTACK, ODISHA	Research Scholar	CUTTACK	ODISHA	9937684113	1-Perfection,2- All session are well delivered and we'll Management
6/5/2020 19:19:46	nethravictory2@gmail.com	NETHRAVATHI.A	Acharya Institute of Graduate Studies	Assistant.Professor	Bengaluru	Karnataka	9740404959	Experts insights
6/5/2020 19:19:52	brpraveen1@gmail.com	Mr. Praveen B	PES Institute of Advanced Management Studies, Shivamogga.	Assistant Professor	Shivamogga.	Karnataka	9611650036	Its nice.
6/5/2020 19:19:52	sfatimafarhat7@gmail.com	S FATIMA FARHAT	WILLIAMS INTERNATIONAL COLLEGE	ASSISTANT PROFESSOR	BANGLORE	KARNATAKA	9741922554	Data is oil well said
6/5/2020 19:19:57	v.rakesh71094@gmail.com	Rakesh N	Presidency College	Assistant Professor	Bengaluru	Karnataka	8553640492	Nutshell of BA was covered - Smoothed Learning
6/5/2020 19:20:01	rayyanriz2013@gmail.com	Rizwana Khanum	Al Ameen Institute Of Management Studies	Faculty MBA	Bangalore	Karnataka	9900398192	Good as It was more towards Application of such analytics
6/5/2020 19:20:06	prethyousasel98@gmail.com	S PRETHYOUSA	BANAGLORE CENTRAL UNIVERSITY	STUDENT	BANAGLORE	KARNATAKA	9535398428	1- very useful information about how analytics is important in the coming future 2- encouraging students to choose a different career path
6/5/2020 19:20:07	anuharry775@gmail.com	Mary Anuveena A	Williams International College	Vice Principal	Bangalore	Karnataka	8105824342	IMMENSE KNOWLEDGE OF APPLYING TECHNOLOGY IN TEACHING PRACTICES
6/5/2020 19:20:09	nraman.dr@gmail.com	Dr N.Raman	Kongu arts and science college Autonomous	Professor of commerce	Erode	Tamil Nadu	9843215319	New insight
6/5/2020 19:20:14	mohanasundari.mba@kongu.edu	Dr.M.Mohanasundari	Kongu Engineering College	Assistant Professor	Erode	Tamil Nadu	9486763908	Key points in business analytics, global level information, some area for business analytics
6/5/2020 19:20:14	archana.motta@atria.edu	ARCHANA MOTTA	Atria Institute of Technology	Asst Professor	Bangalore	Karnataka	9448936454	Insights on the scope of analytics in every sphere
6/5/2020 19:20:16	rayshailendra@gmail.com	Dr. SHAILENDRA YADAV	NARSIMHA REDDY ENGINEERING COLLEGE	Associate Professor	Secunderstand	Telangana	9030407017	What is BA is all about
6/5/2020 19:20:16	drarifnadeem@gmail.com	Dr Arif Nadeem	Bareilly College Bareilly	Associate Professor	Bareilly	Uttar Pradesh	9897608566	Business Analysis Data Analysis Applications to Education Sector Real Life situation Business Model Analysis Policy Making Political Strategy
6/5/2020 19:20:17	nishatullahkhan63@gmail.com	DR.NISHAT ULLAH KHAN	HINDU COLLEGE MORADABAD	ASSOCIATE PROFESSOR & HEAD	MORADABAD	U.P.	9837101419	Sessions were Very informative motivational and inspirational

6/5/2020 19:31:19	s_shyam_prasad@yahoo.com	Dr S Shyam Prasad	International School of Management Excellence, Bengaluru.	Professor	Bengaluru	Karnataka	7259942381	Importance of Analytics Application of Analytics Requirements to be a good Analytic person Trends in Education industry in Analytics How to teach Analytics Result is more important than model or tool Importance of story telling Importance choosing the correct question to answer Gaining insight from data Predictive analytics and cognitive analytics Analytics is a scientific process of transforming data into insights for making good decisions.
6/5/2020 19:31:18	grp.cbs@gmail.com	Gururaj R Patil	Chetan Business School	Assistant Professor	HUBBALLI	Karnataka	09900252108	Webinar was very well organized ,I am new to BA,got good insights.Very enthusiastic to learn further.
6/5/2020 19:31:43	vvijaya@bir.amity.edu	Dr.V VIJAYA	Amity Global Business School	Assistant Professor	Bangalore	Karnataka	9731479479	Fastrac and soceity5.0, Data is oil lubricate it.
6/5/2020 19:32:07	sbamulya2019@gmail.com	Amulya GT	SB college of management studies	Assistant professor	Bangalore	Karnataka	09538695665	Knowledge
6/5/2020 19:32:51	dmchingali1987@gmail.com	DNYANESHWAR MARUTI CHINGALI	BETs JGND BHARATESH COLLEGE OF COMMERCE AND SCIENCE, BELGAUM	ASSISTANT PROFESSOR	BELGAUM	KARNATAKA	9591316187	Very informative, as a beginner I am taking lots of confidence from now with me
6/5/2020 19:32:51	harshilhakm00172@gmail.com	HARSHITHA KM	Skybird aviation college	Lecturer	Bengaluru	Karnataka	9108331319	<ul style="list-style-type: none"> ▣ How analytics is useful in business ▣ importants of business analytics ▣ procedures to do analytics ▣ skills used in business analytics ▣ need for learning BA
6/5/2020 19:32:52	chanda.gulati@gmail.com	Dr. Chanda Gulati	Prestige Institute of Management, Gwalior	Assistant Professor	Gwalior	Madhya Pradesh	7879440096	- BA is future -Data seems playful with knowledge of BA-The predictability of all businesses will be in the hand of business analyst -Business analytics technique knowledge is must
6/5/2020 19:33:27	anushaudayshetty@gmail.com	Anusha U Shetty	Global Academy of Technology	Assistant Professor	Bangalore	KARNATAKA	09060925397	What is the current scenario in the market what is required and what is not required
6/5/2020 19:33:31	anu.allu4@gmail.com	ALLU ANUSHA	V.K.R, V.N.B & A.G.K COLLEGE OF ENGINEERING	ASSISTANT PROFESSOR	GUDIVADA	ANDHRA PRADESH	8096487593	Research process
6/5/2020 19:33:52	dassayan544@gmail.com	sayan das	MAKAUT.WB	student	kalkata	WESTBENGAL	9064722944	larning something new
6/5/2020 19:33:56	swarita.de@nmims.edu	SWARITA DE	NMIMS Deemed to be University	Assistant Professor	Mumbai	Maharashtra	9433138202	An exposure to the domain of Business Analytics
6/5/2020 19:34:02	lakshmi14kashyap@gmail.com	Lakshmi Kashyap	SF Works	Business Analyst	Bangalore	Karnataka	09620196372	<ol style="list-style-type: none"> 1.The evolution of BA, moving towards the cognitive analytics. 2.The reasons why companies fail to pitch in for a data science project, as a business analyst at SF Woks, I see/ hear it happening. Mr Doug has given insights to avoid those or can be considered as scope of improvement. 3. Very importantly the project priority score, quantitative scoring for more clarity and prioritizing. 4.Significance of building the analytical models, interpreting them to make the business decisions real time and the future. 5."Begin with the end in mind" A new insight . 6.fasTrac model 7.Quantitative storytelling 8.Real world analytics challenges 9.Importance of having Proactive with the data and predictions. 10.Scope of perspective analytics in MSMEs.
6/5/2020 19:34:16	sweetysush18@gmail.com	SUSHMITA KUMARI	SURESH GYAN VIHAR UNIVERSITY	STUDENT	JAIPUR	RAJASTHAN	7488551451	Webinar was pretty much awesome. learnt many new things. Kuddo to Penalist and organiser for wonderful webinar. Thanku
6/5/2020 19:34:24	ezaanurooj125@gmail.com	Urfana Amin Moharken	DIET Ganderbal,J&K	Master Resource Person	Srinagar	Jammu and Kashmir	9469430869	World is shifting to online mode very fast. We as teachers need to be updated in technology and information so as to be good facilitators for our students
6/5/2020 19:34:39	pallaviyashu1812@gmail.com	PALLAVI R	Government Women College	BSC	Kolar	Karnataka	9731490253	Good knowledge

Timestamp	Email address	Name as required in Certificate	Institute/Organisation	Designation	City	State	Mobile Number	What are the takeaway from this Webinar? (Please write in bullet points)
6/5/2020 13:57:14	priyajakhar0207@gmail.com	PRIYA JAIN	R V INSTITUTE OF MANAGEMENT	ASSISTANT PROFESSOR	BANGALORE	KARNATAKA	9108300728	LEARNING
6/5/2020 13:57:16	dileep.rvim@rvei.edu.in	Dileep	R V Institute of Management	Assistant Professor	Bangalore	Karnataka	8553276869	Good
6/5/2020 13:59:00	dileepudupi@gmail.com	Dileep	RVIM	Professor	Bangalore	Karnataka	8553276869	Good
6/5/2020 14:10:02	priyajakhar0207@gmail.com	PRIYA JAIN	R V INSTITUTE OF MANAGEMENT	ASSISTANT PROFESSOR	BANGALORE	KARNATAKA	9108300728	MAJOR LEARNING
6/5/2020 14:10:15	dileepudupi@gmail.com	Dileep	R V Institute of Management	Assistant Professor	BANGALORE	Karnataka	8553276869	Good
6/5/2020 14:19:12	santhoshm.rvim@rvei.edu.in	Dr. SANTHOSH M	RVIM	ASSOCIATE PROFESSOR	BANGALORE	KARNATAKA	9739945333	Excellent
6/5/2020 14:23:32	guruduttshenoy@gmail.com	Gurudutt Shenoy	SetConnect Inc.	Partner	Bangalore	Karnataka	9591723825	1) Well organised 2) Learned a lot about BA 3) Confident of getting in to BA now
6/5/2020 14:28:39	nnsreddy.rvim@rvei.edu.in	N.Nagasibba Redfy	R V Institute of Management	Asst.Professor	Bangalore	Karnataka	9845492336	Good
6/5/2020 14:37:20	nnsreddy.rvim@rvei.edu.in	N.Nagasubba Reddy	R V Institute of Management	Asst.Professor	Bangalore	Karnataka	9845492336	Good learning
6/5/2020 17:18:04	dileep.rvim@rvei.edu.in	DILEEP S	R V Institution of Management	Assistant Professor	Bangalore	Karnataka	8553276869	Good
6/5/2020 19:17:31	firojtamboli143@gmail.com	Dr. Firoj Allauddin Tamboli	Bharati Vidyapeeth College of Pharmacy,Kolhapur Maharashtra	HOD Pharmacognosy	Kolhapur	Maharashtra	9503709095	Knowledge
6/5/2020 19:17:40	mukundvaradaraj92@gmail.com	Mukund V Koushik	Seshadripuram College	Assistant Professor	Bengaluru	Karnataka	7892808725	importance of BA
6/5/2020 19:17:40	sunitharamesh77@gmail.com	C R Sunitha	Surana college	Assistant professor	Bangalore	Karnataka	9964296674	Ideas and opportunities
6/5/2020 19:17:57	sowjanyaabhatb1997@gmail.com	Sowjanya Bhat B	R V Institute of Management	Student	Bangalore	Karnataka	8979115118	Business analytics in education and industry play vital role.
6/5/2020 19:17:58	anihcet@gmail.com	P.Anitha	Hindusthan college of Engineering and Technology	Assistant Professor	Coimbatore	Tamilnadu	9994643363	About dealing of real time data Informative
6/5/2020 19:17:59	gisa.george93@gmail.com	Gisa George	ISBR	Research scholar	Bangalore	Karnataka	8123584830	Future oriented curriculum needs to be integrated
6/5/2020 19:18:12	prakashp683@gmail.com	RAM PRAKASH PANDEY	Faculty of Commerce, Banaras Hindu University, Varanasi	Research Scholar	Varanasi	Uttar Pradesh	08960500475	Something more from beginning
6/5/2020 19:18:12	bharath.bc7@gmail.com	BHARATH C	Seshadripuram College	Assistant Professor	Bangalore	Karnataka	8880333834	Streams where BA is applied Scope of BA course
6/5/2020 19:18:16	yvandana50@gmail.com	Vandana shree	Prestige Institute of management, gwalior	Research scholar	Gwalior	Mp	8982870541	Session was wonderful.. I would love to do Business analytics
6/5/2020 19:18:20	markvenkat2012in@gmail.com	Venkatesan D	SRM IST	Asst professor	Chennai	Tamilnadu	9444185030	Deep understanding BA
6/5/2020 19:18:20	km.mahesh@jaincollege.ac.in	Prof K.M Mahesh	SBMJAIN COLLEGE,V.V.PURAM	PRINCIPAL	Bengaluru	Karnataka	9844542284	FASTRACc
6/5/2020 19:18:21	abhaypai2919@gmail.com	Abhay Pai	R V institute of management, Bangalore	Student	Bangalore	Karnataka	7483898039	Basic knowledge
6/5/2020 19:18:19	nshree118@gmail.com	prof. Shree vamshi	Jain University	Asst prof	bangalore	karnataka	9986444074	we had good knowledge about BA
6/5/2020 19:18:22	ishpreet2104@gmail.com	Dr. Ishpreet Virdi	Mata Sundri College, University of Delhi	Assistant Professor	New Delhi	Delhi	9953592559	Overall
6/5/2020 19:18:29	anjallakshmi12@gmail.com	MANJULA L	BMS college for women	Assistant professor	Bangalore	Karnataka	9206939117	Knowledge Business analytics knowledge
6/5/2020 19:18:37	swatikulkarni7064@gmail.com	Swati	SB college of management studies	assistant professor	Bangalore	Karnataka	9742815437	It was a wonderful and insightful session
6/5/2020 19:18:39	mishrasumit243@gmail.com	Sumit Mishra	N.P. University	MBA Faculty	Daltonganj	Jharkhand	9572863311	Beautiful insightful session on business analytics in academia
6/5/2020 19:18:44	macklin@karunya.edu	J. MACKLIN ABRAHAM NAVAMANI	Karunya Institute of Technology and Sciences	Assistant Professor	Coimbatore	Tamilnadu	9865083014	Understood the concepts with clarity
6/5/2020 19:18:49	shruthic_14@yahoo.com	SHRUTHI C	Seshadripuram college	Assistant professor	Bangalore	Karnataka	9886058795	Exposure related to BA Teaching tools
6/5/2020 19:18:53	ishwaryaj.uma9@gmail.com	Ishwarya J	BMS College for Women	Assistant Professor	Bengaluru	Karnataka	9108462401	About HR Analytics
6/5/2020 19:19:02	chaitrachai00@gmail.com	Chaitra P	Bengaluru Central University	Student	Bangalore	Karnataka	7829947413	Huge knowledge about BA
6/5/2020 19:19:05	urdangarwala@gmail.com	CA(Dr.) Umesh Dangarwala	The M S University of Baroda	Associate Professor	VADODARA	Gujarat	9824019199	Enhancing knowledge

6/5/2020 19:30:01	dr.karthik1385@gmail.com	Dr. Karthik Chakravarthy Gollapudi	Amrita Institute of Hotel Management and Business Administration	Assistant Professor	Vijayawada	Andhra Pradesh	7386898478	Information regarding analytics with gud videos as well.
6/5/2020 19:30:06	kiransbcms@gmail.com	A KIRAN KUMAR	SB COLLEGE OF MANAGEMENT STUDIES	ASSISTANT PROFESSOR	Bengaluru	Karnataka	9952281256	Good
6/5/2020 19:30:29	ajit.patro4322@gmail.com	Ajit Kumar Patro	Science College(Autonomous), Hinjilicut	Assistant Professor	Berhampur, Ganjam	Odisha	7008567547	1) Came to know about the US scenario in the BA which is much advanced than india. 2) Know about the Courses from Different institutions. 3) Glad to know 10+1 Doug's data science failure reasons. 4) Specially Empathy in the Quantitative BA educate me about this new thing. 5) I am came to know about the new FASTrac model. 6) Quantitative Story telling is a new term to my vocabulary.
6/5/2020 19:30:43	pavithrag@gsss.edu.in	PAVITHRA GOWTHAM NS	GSSSIETW, MYSURU	Assistant professor	MYSURU	Karnataka	9964315123	Predictive and perspective analytics are changing the analytics games. Self-service is shaping the future of digital analytics by lowering the barriers of entry into the world of BA. Privacy and personalization are going to head in 2020 as consumer become increasingly privacy concious, yet more demanding of their personalized data.
6/5/2020 19:30:48	kirankvket@gmail.com	Kiran Kumar K V	FRED	Program Director	Bangalore	Karnataka	+919964402318	1. Business Analytics is the next career destination for a business management faculty, whether we like it or not 2. Business Analytics is where the money is going forward for individuals, businesses, students and of course us (Faculties)...!!!! 3. Society 5.0 is on its way...and we have the torch to light 4. Industry-Academics collaboration will be at its peak in the coming years 5. FasTrac 6. Doug's top 10 reasons why data science projects fail
6/5/2020 19:30:52	rspratibha2@gmail.com	Dr Pratima Rohidas	VSK University, Ballari	Assistant professor	Ballari	Karnataka	953863786	It's application in today's business environment
6/5/2020 19:30:52	manim2601@gmail.com	Nagamani H R	ASC Silver Valley college	Lecturer in Statistics	Bengaluru	karnataka	7892884662	Real time applications of statistical techniques and modelling which is becoming more prevalent This webinar brought into a greater insight to data science and artificial intelligence
6/5/2020 19:31:07	harishvec@gmail.com	Dr. S. HARISH	VIJAYA EVENING COLLEGE	Principal	BENGALURU	KARNATAKA	9448463466	Entered the Webinar as an illiterate, going out as a semi-literate. Still long way ahead to become literate.
6/5/2020 19:31:11	anitabsomanna@gmail.com	ANITA B.S.	PVP FIRST GRADE COLLEGE, BANGALORE	Associate Professor	BANGALORE	KARNATAKA	7624990843	Awareness of new innovations and developments in the field of BA, which if our University introduces this in many Streams, this subject will develop and Students would reap immensely in India and abroad, we by using these techniques our Teaching would be very interesting, effective and Gaining for our students

6/5/2020 19:28:54	anithasorcar@gmail.com	Anitha BM D'silva	R V Institute of Management	Senior Assistant Professor	Bangalore	Karnataka	9742278574	Session of Mr. Doug Grey why Data Science projects fail 10 points explaiend in brief and 11th being Empathy. Dr. Ramesh Gopalan session on Business analytics and today session Recommendations for Academia where we are Building curriculum foundation based on ASK which is Attitude , skills, and Knowledge. Career counselling and career management.
6/5/2020 19:28:57	geevarathna@gmail.com	Dr.Geevararhna	Acharya Bangalore B School	Associate Professor	Bangalore	Karnataka	+919986738666	Significance of BA Data scientist and future scope How/whete to look for opportunities in BA Industry /sponsor integration
6/5/2020 19:29:00	akashvasan06@gmail.com	Akash Vasan	Seshadripuram Institute of Management Studies	Assistant Professor	Bengaluru	Karnataka	9606203860	The need for business analytics in industry and academia has been reaffirmed. The potential for businesses to grow by using analytics has been well understood.
6/5/2020 19:29:12	profvenkat40@gmail.com	Dr. P. Venkataiah	Osmania University	Professor	Hyderabad	Telangana	9441990616	Data driven business
6/5/2020 19:29:13	anshusrikant@gmail.com	Dr Anshu Dixit	IMS, Lucknow University	Subject expert	Lucknow	Uttar Pradesh	9721330489	Good knowledge bfor Analytics process in our area
6/5/2020 19:29:16	shaiks86@gmail.com	Mahabub Basha S	ISBR, University of Mysore	Research scholar	Bangalore	Karnataka	9844126184	How to teach effectivily business analyst
6/5/2020 19:29:18	dyuti.sinha@thebges.edu.in	Dr.Dyuti Sinha	The Bhawanipur Education Society College	Faculty(Economics)	Kolkata	West Bengal	9474486216	Gained a lot of idea and knowledge in application of BA
6/5/2020 19:29:24	sanjay@bldeaspcc.ac.in	Dr Sanjay Subhas Hanagandi	BLDEA's A S PATIL COLLEGE OF COMMERCE AUTONOMOUS, MBA PROGRAM VIJAYAPUR	Assistant Professor	Vijayapur	Karnataka	9880132122	Currently required course to be introduced. Getting updated on BA.
6/5/2020 19:29:27	sandhya.jingade29.sj@gmail.com	Sandhya Gopinath	Bapu degree college	Asst. Professor	Bengaluru	Karnataka	09986140967	VERY KNOWLEDGEABLE
6/5/2020 19:29:41	ramyas.rvim@rvei.edu.in	Ramya S	RV Institute of Management	Assistant Professor	Bangalore	Karnataka	9741849806	1. Webinar helped me in understanding the importance of BA in the field of education and the vast opportunities available for educators to upskill themselves and contribute the same the institutional development. 2. Business analytics is the need of the hour. 3. How BA has taken its proficient space in all the fields of management. 4. Various education models and frameworks for education system. (Intrested about the course mentioned by Ramesh)
6/5/2020 19:29:44	meenakshikouta99@gmail.com	Kouta Meenakshi Mrudalashree	Malla Reddy Engineering College For Women	Student	Hyderabad	Telangana	9701779900	I understood the scope of business analytics and got the interest to join
6/5/2020 19:29:43	kavya13r@gmail.com	KAVYA R	Vivekananda degree college for women	Assistant professor	Bangalore	Karnataka	7019381562	Very informative session Enhancement of Knowledge
6/5/2020 19:29:52	tejashreebhat0027@gmail.com	Tejashree Bhat	RV Institute Of Management	MBA	Bangalore	Karnataka	9482186292	>how to make business decisions >develop basic data literacy and analytic mindset >what are the different methods that can be used >BUSiness Analytics have demand >can get better insights about the business and market.
6/5/2020 19:29:58	bharathdvmurthy21@gmail.com	Bharath Kiran D V	R V Institute of Management	Student	Bengaluru	Karnataka	7676423766	The real take aways for me were: >Data is the new oil >Empathy factor that is putting ourself in the customers shoes is quintessential for the success of a business >With the Society 5.0 booming on a global scale, taking interest in Business analytics is not an option but a lifeline. >With integration of analytics in all sectors such as vehicle insurance, etc having basic or advanced level knowledge on analytics is mandatory. > Customers or the target population only look for "what's in it for me", meeting that expectation is what matters in both short and long run of business. >Learning, Unlearning and Relearning is the new mantra in the 21st century.

6/5/2020 19:28:07	anushaudayshetty@gmail.com	Anusha U Shetty	Global Academy of Technology	Assistant Professor	Bangalore	KARNATAKA	09060925397	The actual scenario what is happening in market What is required and what not to do
6/5/2020 19:28:07	navatha2008@gmail.com	Navatha S	SB college of management studies	Assistant professor	Bangalore	Karnataka	8123297963	I got the clear picture about why analysis is required
6/5/2020 19:28:09	sfatimafarhat7@gmail.com	S FATIMA FARHAT	WILLIAMS INTERNATIONAL COLLEGE	ASSISTANT PROFESSOR	BANGLORE	KARNATAKA	9741922554	Business analytics model
6/5/2020 19:28:17	sunandag22@gmail.com	Dr. Sunanda Jindal	ASM'S Institute of Business Management and Research, Pune	Assistant Professor	Pune	Maharashtra	8605166397	1. Provides a competitive advantage to companies. 2. Business analytics combines available data with various well thought models to improve business decisions. 3. Analytics Keep You Updated 4. Analytics Encourages Smart Decision-Making. 5. Computer models based on data analytics help companies see shifts in what customers buy and give a clear picture of what products should be highlighted or updated.
6/5/2020 19:28:28	mamta.a.chawla@gmail.com	Ms.Mamta Chawla	Amity Global Business School, Noida, Amity University Uttar Pradesh	Assistant Professor	Rajouri Garden	New Delhi	09968852668	-scare of the area being too complex -identified my domain to further go in deep -must to learn in academics given digital world expanding
6/5/2020 19:28:30	mansurali@psgim.ac.in	Mansurali Anifa	PSG Institute of Management	Assistant Professor (Senior Grade)	Coimbatore	Tamil Nadu	9976532755	Curriculum Framework
6/5/2020 19:28:35	mr.pawan.kumar1993@gmail.com	PAWAN KUMAR RAO	Babasaheb Bhimrao Ambedkar University, Lucknow	PH D Research Scholar	Lucknow	Uttar Pradesh	8009529434	Business Analytics is new area for me I knew about it And i learned many tools and techniques about BA
6/5/2020 19:28:35	zeeshan_athani@rediffmail.com	Mohd Zeeshan Athani	RV Institute of Management	Student	Bengaluru	Karnataka	9731168924	1. Importance of business analytics in life. 2. Real time examples of usage of business analytics. 3. How the future will look like with the presence of business analytics. 4. Information about analytics which I wasn't aware of. 5. How organizations use analytics for their survival in the market.
6/5/2020 19:28:36	rohisultana171@gmail.com	ROOHI SULTANA	EDUCATION DEPARTMENT	Resource person/Teacher	Srinagar Kashmir	Jammu and Kashmir	8082549848	1 communication skill is very important for BA 2 Technology is also important 3 if you are interested in business then you should go for there 4 No cheating
6/5/2020 19:28:42	nilashisbakshi2001@gmail.com	NILASHIS BAKSHI	Maulana Abul Kalam Azad University Of Technology, West Bengal	BBA in Business Analytics	Kolkata	West Bengal	9163195136	• Informative Knowledge about Business Analytics.
6/5/2020 19:28:43	ushayuvvaraja@gmail.com	Prof. Usha.I	GRV BUSINESS MANAGEMENT ACADEMY	Asst. Prof	Bengaluru	Karnataka	8660764707	1. Conceptual understanding of the Topic. 2. Really willing to take up BA as a profession 3. we are sort of equipped to suggest our students to take-up BA as career.
6/5/2020 19:28:43	parvathid47@gmail.com	B. PARVATHI DEVI	SB College of Management Studies	Principal	Bengaluru	Karnataka	9483415235	Session was very informative and helpful
6/5/2020 19:28:46	indranilmukherjee44@gmail.com	Indranil Mukherjee	Maulana Abul Kalam Azad University Of Technology W.B	student	kolkata	west bengal	9875547461	we took fundamental knowledge of data science and various future projects
6/5/2020 19:28:46	drmadhus73@gmail.com	Dr. Madhu S	The National College	Professor	Bangalore	Karnataka	9448082504	Knowledge Enrichment
6/5/2020 19:28:51	radhi3sree@yahoo.co.in	Dr.P.V.Radhika	TSR & ERR Government Degree College,Pamaru	Assistant Professor	VIJAYAWADA	ANDHRAPRAD ESH	9849449735	Treasure of Data and Knowledge Analytical and expressive Sound knowledge of Business Analytics arena. Research oriented Motivation to students to choose as unique Specialisation. Faculty Enlightenment and Enrichment Ability to transfer this treasure house to our students.

**REPORT OF WEBINAR
ON CUSTOMER EXPERIENCE MANAGEMENT**

 **RV Institute of Management**

Go, change the world

Webinar
on
Customer Experience Management (CXM)
Aligning with the Customer Journey

Date: Friday, 19th June 2020

CX in Action

 **RV Institute of Management**

Line Webinar

CUSTOMER EXPERIENCE MANAGEMENT
Aligning with the customer journey

Click To Register
For queries, contact Prof. Anitha D'silva @
9742278754, anithadsilva.rvim@rvet.edu.in

 19th June, 2020
 11 AM- 1 PM IST

 DR. PURUSHOTTAM BUNG Director, RVIM, Bengaluru India	 MR. K B NAGARAJU Director at Innovative Retail Concepts Pvt Ltd (Big Basket)	 MR. GURUDUTT SHENOY CX & Education Mentor and Adjunct Faculty, RVIM Bengaluru
--	---	--



WEBINAR ON CUSTOMER EXPERIENCE MANAGEMENT

Date: 19-6-2020

Venue: Virtual/ Institute

Time: 11.00am to 1.30pm

Target Audience: Faculty, research Scholar, Industry personnel

No. of Participants: 205

Event Coordinator: Prof. Anitha B.M. Dsilva

Objectives

- To comprehend on the concepts of Customer Experience management
- To present CEM with relate to service organisation`s/ online platforms
- To organise webinar online and provide interactions to the participants during the pandemic situation

Agenda/Flow of the Event

- Session 1 : Evolution and Emergence of Customer Experience Management
- Session 2: CXM concepts and Frame work
- Session 3: Customer Experience- The cool strategic tool of Big Basket
- Session 4: CXM in Education and the way forward
- Question and answer session

PROFILE OF WEBINAR SPEAKERS

Dr. Purushottam Bung (Evolution & Emergence of CXM @RV Institute of Management)

Dr. Purushottam Bung is an Engineer with rich experience in various departments of production at 'VIDEOCON' and also at some of the Australian companies in various capacities. during his stay at Melbourne, Australia. He has a total of 22 years of experience as an Academician at various renowned Institutions along with 03 years of rich experience in industry. Dr. Bung was conferred with "Distinguished Educator" award by the Discovery Media, New Delhi in 2013. In 2015 he has been awarded as 'Best Director of a B-school in Karnataka' as part of Education Excellence Awards – 2015 by Brands Academy, Delhi. He is member of many Associations and Institutional bodies like: AIMA, AIMS, ISTD, NHRD, SMF, ISABM, MEDC, SEE, EPSI, AICP, MTC Global, etc. He is mentoring many new local entrepreneurs under 'Navodyami' program of Deshpande Foundation, Hubli sand box region and is an active member of TiE (The Indus Entrepreneur – A global entrepreneur`s network).

Mr. Gurudutt Shenoy (CX Framework & Implementation-A Case study of Amazon @RV Institute of Management)

Mr. Gurudutt Shenoy is a seasoned leader with over 30years of industry experience in Marketing & Business Strategy, Customer Experience Management & Design Thinking in India and abroad. Mr Shenoy has worked in a wide range of industries ranging from Machine Tools, Cutting Tools, Computers, Automobile & Travel and has exposure to a wide range of international brands - Toyota, Ford, Kia, Wipro, Widia Kennametal and HMT. Currently, he is actively working with RVIM as Adjunct Faculty and driving several initiatives towards preparing the students better for Industry. He has conducted many Faculty Development Programmes and published a paper on Customer Experience in India. He is an Engineer from NIT, Karnataka and a PGDM from IIM, Calcutta.

Mr. K B Nagaraju (Customer Experience- The core Strategic Tool of Big Basket @RV Institute of Management)

KBN as he is known, has over 38 years of rich experience in Hi-tech, Automotive, Logistics and E-commerce sectors. He is a Mechanical Engineer (1981-College of Engineering Guindy, Madras) and an alumnus of IIM Calcutta (1985). Currently as Chief Customer Experience Officer, Bigbasket, he takes care of customer facing functions: Delivery operations and Customer Service. BigBasket is the largest e-commerce company in the groceries space with presence in 10 metro cities and 16 Tier 2 cities with over 20000 employees and handling more than 6 million orders per month. In a career spanning nearly 4 decades, he held senior management positions at TVS Logistics Services India Pvt. Ltd as its COO, Lenovo India as its VP- Supply Chain, DB Schenker India as Director- Logistics and Hewlett Packard India as its Logistics Head. A veteran in Supply Chain and Logistics domains, he is a regular speaker in Supply chain and Logistics/E-commerce related seminars and conferences in India and abroad.

Feedback/ Coordinators Comment:

Some facts about the case

Year 2000

- On the verge of shutting down
- Sales dropped to 2000 a month
- Too many complaints: engine seizures, electrical failures, oil leakages, daunting kick start,...
- Quality issues: Too heavy, difficult to maintain,
- Customer Experience deteriorating



Year 2016

- Sold 508099 motorcycles (Rs. 5226.87 Cr)
- Annualized growth of 56.14%
- Market share of 98% in mid size (250cc)
- EBITDA margin: 28.3% (401.49 Cr)



Some facts about the case

Year 2000

- On the verge of shutting down
- Sales dropped to 2000 a month
- Too many complaints: engine seizures, electrical failures, oil leakages, daunting kick start,...
- Quality issues: Too heavy, difficult to maintain,



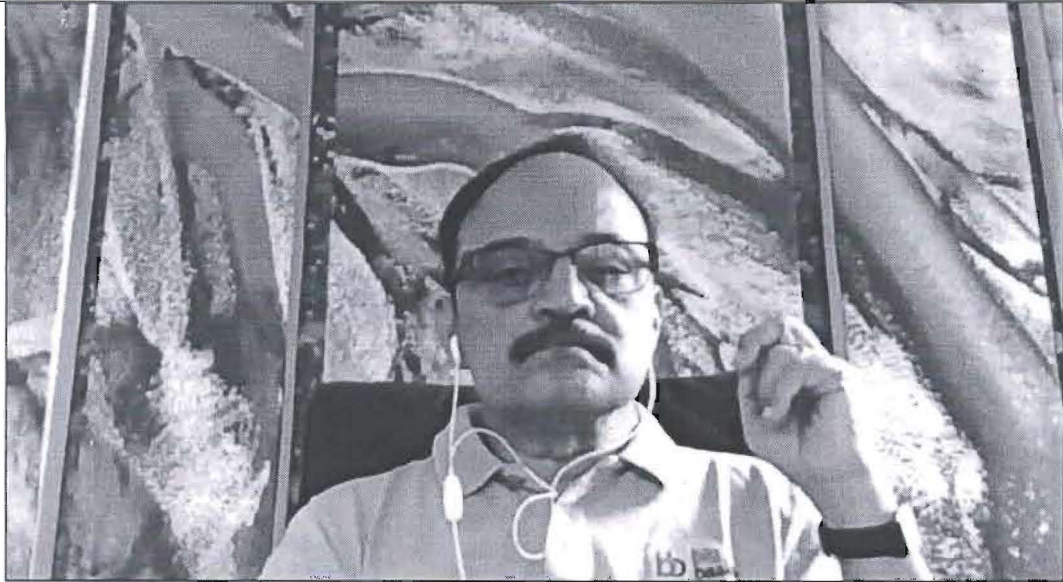

Mr. K B Nagaraju (Customer Experience- The core Strategic Tool of Big Basket @RV Institute of Management)

Outcome achieved/ attained:

The participants were able to understand about the need for CXM using Blooms Taxonomy

Bloom's Taxonomy - Psychomotor

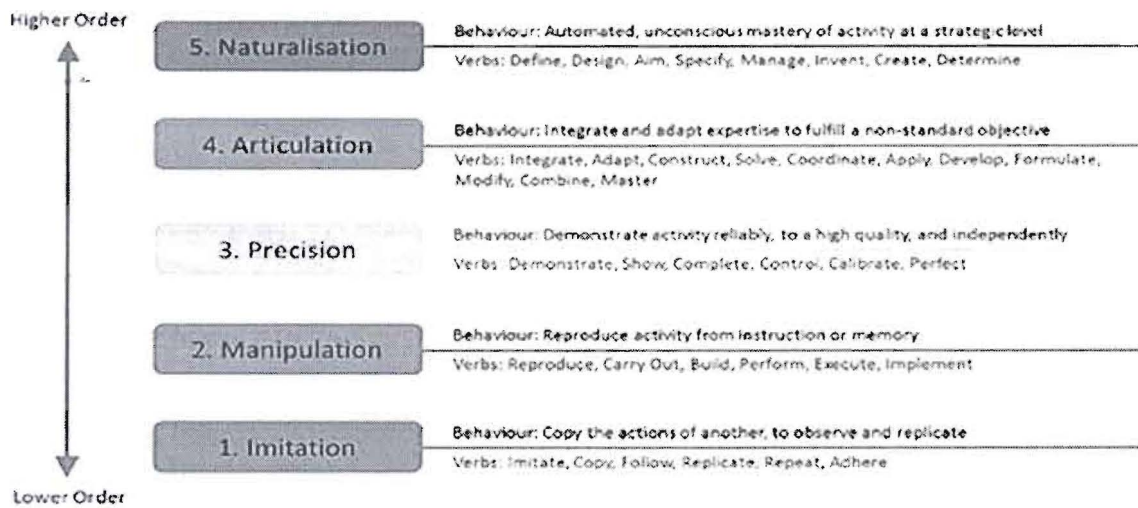

Copyright by Ivan Tok Blanningham, September 2016

Webinar Flyer

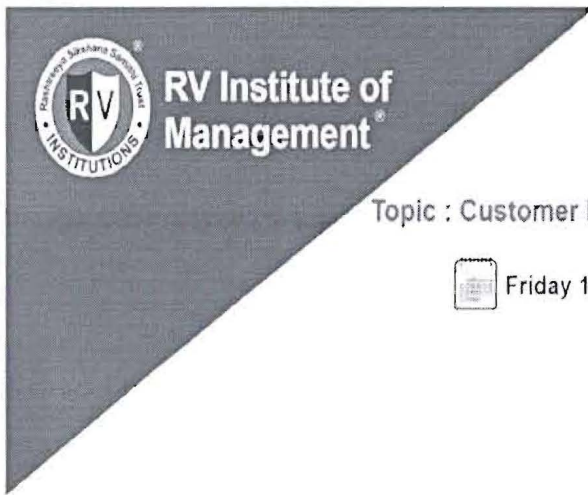

Go. change the world

Live Webinar

Topic : Customer Experience Management - *Aligning with Customer Journey*



Friday 19th June 2020



11.00 am to 1.00 pm

KEYNOTE SPEAKER



Mr. D. Shivakumar
(TENTATIVE, CEMIN BY 15th JUNE)
Group Executive President
Corporate Strategy & Business,
Aditya Birla Group.



Dr. Purushottam Bung
Director
RV Institute of Management.



Mr. K B Nagaraju
Director at Innovative Retail
Concepts Pvt Ltd (Big Basket)



Mr. Gurudutt Shenoy
CEM Consultant & Adjunct Faculty,
RV Institute of Management

Report Prepared by

Prof. Anitha BM D'silva

**Department of marketing
Director**

RVIM



RASHTREEYA SIKSHANA SAMITHI TRUST

R V INSTITUTE OF MANAGEMENT

CA 17, 26 Main, 36th Cross, 4th T Block, Jayanagar

Bengaluru, Karnataka 560 041

Thought Leaders Speak Series: “Leadership During Crisis”	
Resource Person	Mr Bhaskar Rao, IPS, Additional Director General of Police, Bangalore
Date: February 06, 2021	Venue: Seminar Hall, III Floor, RVIM
Time: 9:00am to 11.00am	Target Audience: I & III Sem MBA Students
No. of Participants: 200	Event Coordinators: Dr. Anupama K Malagi, Mr S K Manjunath
Objectives The objective of the Thought Leaders Speak series is – <ul style="list-style-type: none">➤ To inculcate the strong values and also➤ To facilitate students to learn from the life experiences of the illustrious personalities who are invited as part of these series.	
Brief summary of the Event RVIM organised the event where Sri Bhaskar Rao, IPS , ADGP, Bengaluru was invited to share his experiences during the COVID situation which was really challenging. Students of I & III Sem participated in the event and benefitted immensely from the talk.	

Profile of the Resource Person:

OVERVIEW OF SHRI. BHASKAR RAO, IPS
Additional Director General of Police



Sri. Bhaskar Rao is an Indian Police Service officer of 1990 Batch and allotted to Karnataka Cadre.

Since then he has held several positions as Superintendent of Police and Deputy Commissioner of Police in Mandya, Davanagere, Shimoga, Hubli-Dharwar City, Kodagu, Bangalore City and Bangalore Rural District.

Sri. Bhaskar Rao also served as **Commissioner of Police, Bangalore City** overseeing 11 DCP's (Law and Order & Traffic) and 11 DCP's of Special Units of Bengaluru City. His tenure witnessed a roller coaster ride with **ZERO law and order event**. It was the peak of daily **Anti CAA protests and rallies** and the pressure of management of Bangalore City during the onset and **peak of COVID-19**.

Sri. Bhaskar Rao was closely associated with protection of Foreign Companies in the aftermath of 09/11 attacks in USA while he was Superintendent of Police, Bangalore Rural District.

He worked as Managing Director, (KEONICS) of Karnataka State Electronics Development Corporation Limited where several innovative schemes were started. Sri. Bhaskar Rao was also Director, Operations in KSRTC at a time when the organisation was metamorphosing into a corporate organisation like Induction of Volvo Buses, Electronic Ticketing Machines, Biofuels, New Software for Depot Computerization and Booking of Tickets and Commuter Relation.

Sri. Bhaskar Rao served as **Transport Commissioner, Government of Karnataka** during which time Revenue collections increased two fold, Infrastructure expanded and the personnel were skilled, Licence and Vehicle Registration was made Online and Chip based Smart Cards started being issued instead of Licence books and R.C. books.

Sri. Bhaskar Rao also served as **Commissioner of Police, Mysore City**, Inspector General of Police of several Verticals like Anti-Terror, Central Range, Railways, Training, Forest, Commissioner of Police, Belgaum City and Northern Range and he served as Additional Director General of Police, Karnataka State Reserve Police overseeing 12 Battalions and 2 Battalions of India Reserve Police Battalion.

As Inspector General of Police, Internal Security, he was instrumental in creating Karnataka State Industrial Security Force and laying the foundation to streamline and strengthen 4.60 Lacs Private Security Personnel and 1500 Private Security Agencies all over Karnataka. Under his leadership the Coastal Security Police

was strengthened by having excellent collaboration with Indian Navy, Coast Guard and Goa Shipyard.

At present again he is holding charge as Additional Director General of Police of Internal Security Division.

He is decorated with

- (1) President's Police Medal for Meritorious Service-2008.
- (2) President's Police Medal for Distinguished Service 2015.
- (3) United Nation's Medal for the Services Rendered in International Peacekeeping in War Zone, Kosovo, Yugoslavia-2000.

Innovation, Change, Dynamism and Strengthening and Empowering the Bottom of the Pyramid are his Professional Management Passion.

His Personal Passion is Teaching, Fitness and Long Distance Cycling.

Photo Gallery:





Outcome Achieved/ Attained:

This program helped us in learning from the vast experience of the resource person and understand the concept of leadership from a whole new perspective. It also helped the participants to gain insights on various facets of Leadership, challenges encountered and the readiness to overcome these challenges .

Event Coordinators



Director



RASHTREEYA SIKSHANA SAMITHI TRUST

R V INSTITUTE OF MANAGEMENT

CA 17, 26 Main, 36th Cross, 4th T Block, Jayanagar

Bengaluru, Karnataka 560 041

Teaching Learning Centre	
“How Teachers can make a difference”	
Resource Person	Dr Shreepad Karmalkar, Professor, TLC IIT Madras Dr Edamana Prasad, Professor, TLC IIT Madras
Date: June 29 & 30 , 2020 July 1, 2020	Venue: Conference Hall, I Floor, RVIM
Time: 9:00am to 11.00am	Target Audience: RVIM Faculty members
No. of Participants: 20	Event Coordinator: Dr. Anupama K Malagi
Objectives The objective of the Teaching Learning Centre is <ul style="list-style-type: none">➤ to strengthen the Teaching Learning environment in the Institution➤ To encourage innovative pedagogical tools	
Brief summary of the Event RVIM TLC organised the orientation session in association with TLC, IIT Madras for the benefit of all the faculty members. The following is the schedule for the 3 day program:	

Time table:

Jun 29	2-00 to 3-30 pm	How and how much difference can a teacher make
Jun 29	4-00 to 5-30 pm	The concept of Learning outcome
Jun 30	2-00 to 3-30 pm	Recipe for effective and efficient teaching - 1
Jun 30	4-00 to 5-30 pm	Recipe for effective and efficient teaching - 2
Jul 01	2-00 to 3-30 pm	Setting up a TLC (for TLC core team)

All sessions are extensively activity based.

The Recipe for Effective and Efficient Teaching covers the following.

- 1) Begin by designing questions for assignments, tutorials and (may be) tests or quizzes
- 2) Write learning outcomes (LOs)
- 3) Organize content around LOs
- 4) Content delivery:
 - pay due attention to your body language and how you speak
 - use analogies in explanations
 - power point versus blackboard
- 5) Test / quiz students frequently and provide feedback on students' answers to questions
- 6) Seek feedback on your teaching from students and colleagues
- 7) A teacher must appear to the students as competent and caring

Profile of the Resource Persons:

Dr Shreepad Karmalkar is a Professor of Electrical Engineering at IIT Madras (IITM). His twin interests are semiconductor devices and education. For his research contributions, he has received the 2006 Vikram Sarabhai Award and a 2007 IBM Faculty Award. His video lecture series on semiconductor devices and research skills hosted on internet are quite popular. He is an Associate Editor of IEEE Transactions on Education, an IIT Council Member, Head of IITM Teaching Learning Center, and Chairman of AICTE's Board of PG Education and Research. He was Chairman of (south zone) JEE 2007, a Member of National Working Group of DIT GOI in Nanotechnology, and a member of AICTE's Board of UG Studies. He has held visiting assignments at US universities, namely - UC Santa Barbara, RPI and USC. He is a strong espouser of holistic education, and a multilingual.

Dr Edamana Prasad is working as a Professor at Department of Chemistry, Indian Institute of Technology Madras. His research interests are in the area of light-matter interaction. In addition to Chemistry research, he is also interested in teaching – learning. He was former head of Teaching Learning centre (TLC) at IIT Madras and presently associated with the centre as a core team member. He has been awarded the prestigious Alexander von Humboldt Fellowship (AvH) from Germany and Young Faculty Recognition Award (YFRA) from IIT Madras for his contributions in research and teaching. He has conducted several faculty development programs and teaching workshops for faculty members in the higher education sector of the country.

Outcome Achieved/ Attained:

This program helped us in learning from the vast experience of the resource persons and understand the best practices adopted by the TLC at IIT Madras.

It also helped us in strengthening the teaching learning environment in the Institution.

Event Coordinator



Director



WORKSHOP on KNOWLEDGE ACCESS THROUGH J GATE AND OPEN RESOURCES IN MANAGEMENT	
Date: 11 th September 2020	Venue: Zoom webinar
Time: 11 am to 2 pm	Event : Workshop
No. of Participant: 117	Event Coordinator: Prof. Priya Jain Ms. Anupama S M Mr. Shivakumar Ms. Lalitha
Objectives <ul style="list-style-type: none">- To learn about the usage of J-GATE and how it can help to enhance the research skills of the research scholar.- To recognize various e resources available to upgrade the research	
Agenda/Flow of the Event <ul style="list-style-type: none">• Session 1:- Mr. Ravi Shankar explained about the usage and importance of J-Gate for academicians and research scholars.• Session 2:- Dr. Rajendra Babu took the session on e- Resources for Management and Business	
Outcome Achieved/ Attained: <ul style="list-style-type: none">- Mr. Ravi Shankar demonstrated how to use J GATE for enhancing the research skills.	

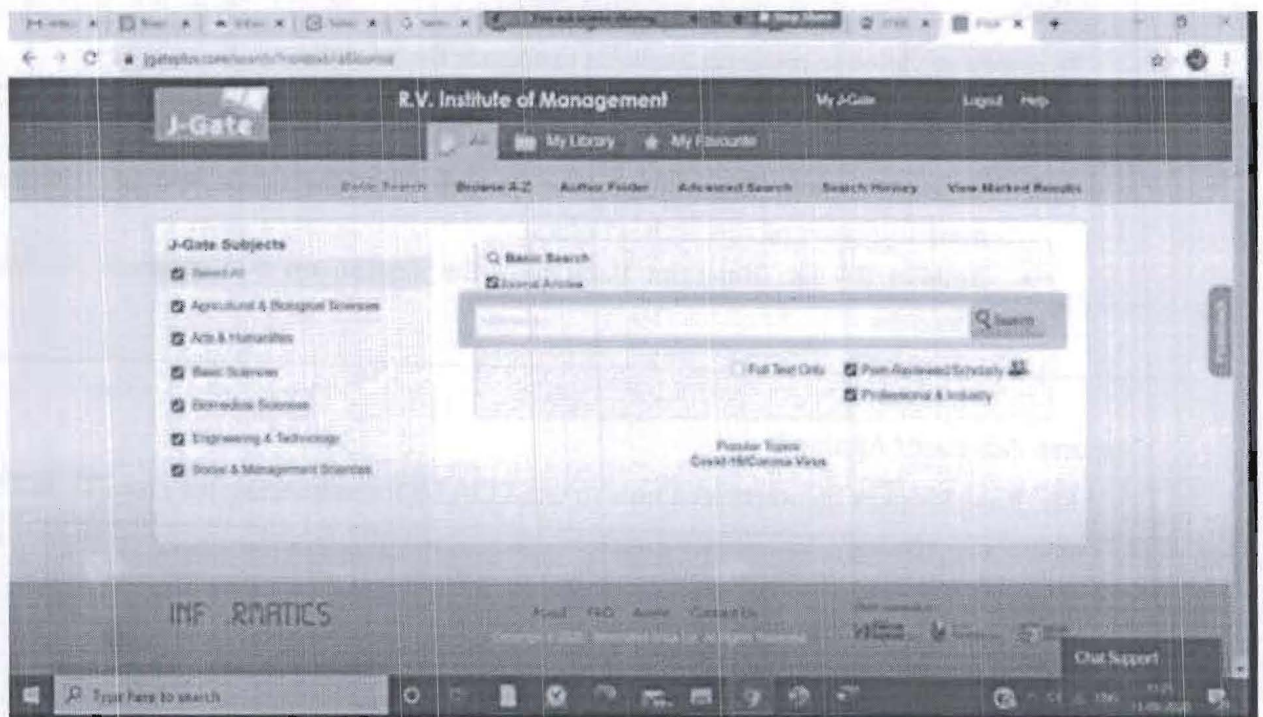
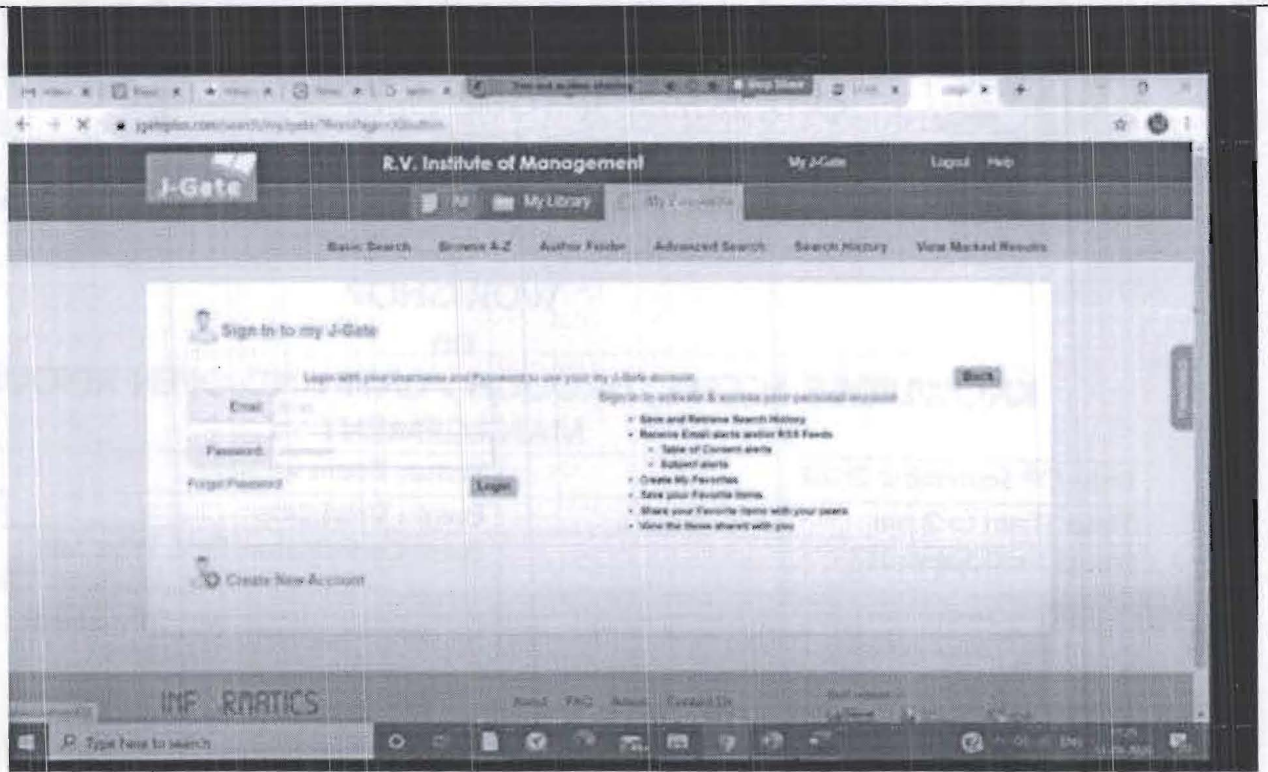

- Mr. Rajendra took over the session on the various other tools available for gathering data for research and other topics.

Products of Scholarly Communication

- Ebsco Discovery tool – Federated Search
- Commercial Journal platforms
 - Elsevier ScienceDirect
 - Springer Link
 - Emerald Insight
- Citation Indices
 - Web of Science - 33,000 titles (SCI- 8,850 jls, SSCI-3,500 jls, and HCI-1700 jls)
 - Scopus - 22,600 titles
 - Google Scholar/ Citeseer/Adademia/Mendley/ ResearchGate
- Jgate/ Fedgate - >32000 jls, 1000's of e-books & other scholarly info.
- iScholar - 300+ All Indian Journals online
- Open Access sources
 - DOAJ – >15000+ jls from 132 countries
 - DOAB – >10000 eBooks
 - PLoS, BioMedCentral and so on



Open Access Bibliographic/Citation/Full Text Sources

- ResearchGate
 - 11 M Researchers, 100 M Publications
- Academia
- Mendley
- Patents Databases
 - US Patents Office (USPTO)
 - Japanese Patents office (JPO)
 - Indian Patents
- Nobel Prize Internet Archive (1901+) - <http://almaz.com/nobel/nobel.html>
- World Bank Open Data - <http://data.worldbank.org/>
- IMF e-Library Datahttp – <http://elibrary-data.imf.org/>

Feedback & Coordinator Comment:

The entire program was very well received by all the participants. Everyone appreciated about the content shared by the resource people and also about the organization of the workshop. It was full of learning session.

Event Coordinators

Prof. Priya Jain

Ms. Anupama S M

Mr. Shivakumar

Ms. Lalitha

Director

Dr. Purushottam Bung

Annexure 1	Proposal / Approval	Not applicable
Annexure 2	Circular / Brochure of the event	Attached
Annexure 3	Brief profile of the speaker	Attached
Annexure 4	Attendees list	Attached
Annexure 5	Photo Gallery	Attached
Annexure 6	Detail Feedback	attached
Annexure 7	Certificate copy	attached

Annexure 2
Circular / Brochure of the event
Brochure

Go. Change the world

R.V. Institute of Management

Centre for Knowledge Resources

Presents

Workshop

On

KNOWLEDGE ACCESS THROUGH J-GATE AND OPEN RESOURCES IN MANAGEMENT

11 September 2020

11 am to 2 pm

library.rvim@rvei.edu.in

Ms. Anupama (9739697154)

Resource people:

- Mr. Ravi Shankar from J-GATE
- Dr. Rajendra Babu, professor at Tumkur University

• Free Registration

• E-Certificate will be provided to all the participants

Registration Link:

https://zoom.us/webinar/register/WN_7sR3l2LvQzSCGMhrNme2SA

Annexure 3
Brief profile of the speaker

Brief Profile of the Resources Persons

1. Mr Ravi Shankar

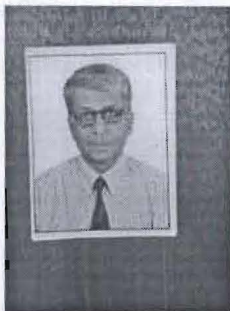

- Ravi Shankar has a basic degree in Electronics engineering from the university college of engineering Bangalore, and a research background in Aerospace engg. from the Indian Institute of Science, Bangalore.
- After this, he joined the Dept. of Atomic Energy (Power Projects Division) where his responsibilities were primarily in the installation, test and commissioning of Distributed Digital Control Systems, SCADA and PLC systems used in Atomic Power plants.

- Parallely, he was also responsible for setting up tropo-scatter and line-of-sight antenna systems used by the Ministry of Communications.
- After 12 years with the Dept. of Atomic Energy, he joined a French oilfield services company, Schlumberger, who had a very strong global presence in Automatic Test Equipment for testing VLSI boards used in radar applications. In this domain, his responsibilities were in maintaining radar and avionic systems deployed by the Defense and Space Ministries with mixed signal (analog & digital) test capabilities.
- He spent 4 years with Schlumberger after which a two years stint followed at the the Research labs of Philips in Eindhoven where he was assigned to a group developing EW (Electronic Warfare) and ECM (Electronic Counter Measures) systems for use in NATO deployed applications
- Currently with Informatics Global, his interests are in training and managing the Company's large base of consortia clients across the country.

2. Dr. Rajendra Babu H

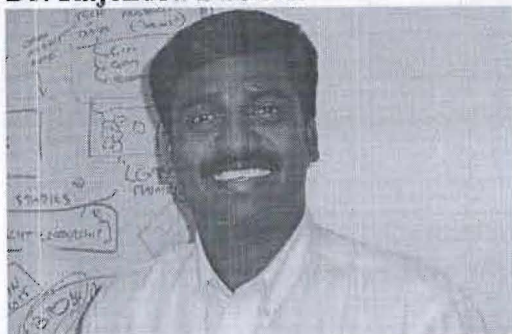

Dr. Rajendra Babu H has done his Bachelor in Science, Bachelors and Masters in Library and Information Science from Bangalore University. He has done his post master's training in "IT Applications to Library and Information Services" in National Centre for Science Information (NCSI), Indian Institute of Science (IISc), Bangalore. He has done his doctoral studies on "Open Access Journals" from the University of Mysore.

He has 24 years of professional working experience in Multinational companies (Hindustan Lever Research, GE Research, Brigade Corp., Capco, Symphony Services and Wipro Technologies) and Academia (Indian Institute of Science-IISc). Presently he is working as a faculty in the Dept. of Studies and Research in Library and Information Science, Tumkur University, Tumkur. He is also working as

- **Coordinator- Skill Development Cell**, Tumkur University
- **Served as a Nodal Officer – Rashtriya Uchchar Shiksha Abhiyan (RUSA)** for Tumkur University
- **Special Officer – ICT Initiatives** responsible for implementing recommendations of Knowledge Commission and RUSA at the Tumkur University level.
- **Nodal Officer – All India Survey for Higher Education (AICHE)** for Tumkur University
- **Nodal Officer – NIF Rankings** for Tumkur University

- **E-Attestation Officer – State Scholarship Portal, Tumkur University**

He is an excellent communicator and a small scale behavioral trainer as well. He possesses knowledge of Database Searching and Retrieval, Content/Knowledge Management, Database development. He has expertise in Content Research, Summarizing key financial services industry research reports, bringing out domain/technology alerts, newsletters and so on. Proficient in Library Services/ Management, Documentation, setting up corporate Consortiums, Journals/ Database sales and Training, Research and Analysis, Usage Tracking, Knowledge Management, Publishing, Web Based Information Services, Six Sigma Initiatives, marketing Information services and Administering/ creating corporate quality Delivery Methodologies. He has worked on SharePoint portal and Documentum. He has extensive experience in Developing and managing world-class Information and Knowledge centers, Content Research functions in HLL (Unilever), GE, Capco, Symphony Services Corp. and Wipro technologies as well as a good team player working with cross border teams.

He has published 68 papers in National/ International journals/ conferences and co-authored 4 books. He has been awarded best paper award for SIX of his publications. Presently 3 full time research scholars are working under his guideship.

He is a six sigma Green belt certified, NCC ‘C’ Certified and represented Karnataka State in ‘Volley Ball’. He is a member of professional organizations such as NCSI-NET, LIS-FORUM and Karnatak state library association (KALA). Presently serving as a governing council member and has served as General Secretary in Karnataka State Library Association (KALA), Bangalore, India.

Annexure 5 Photo Gallery

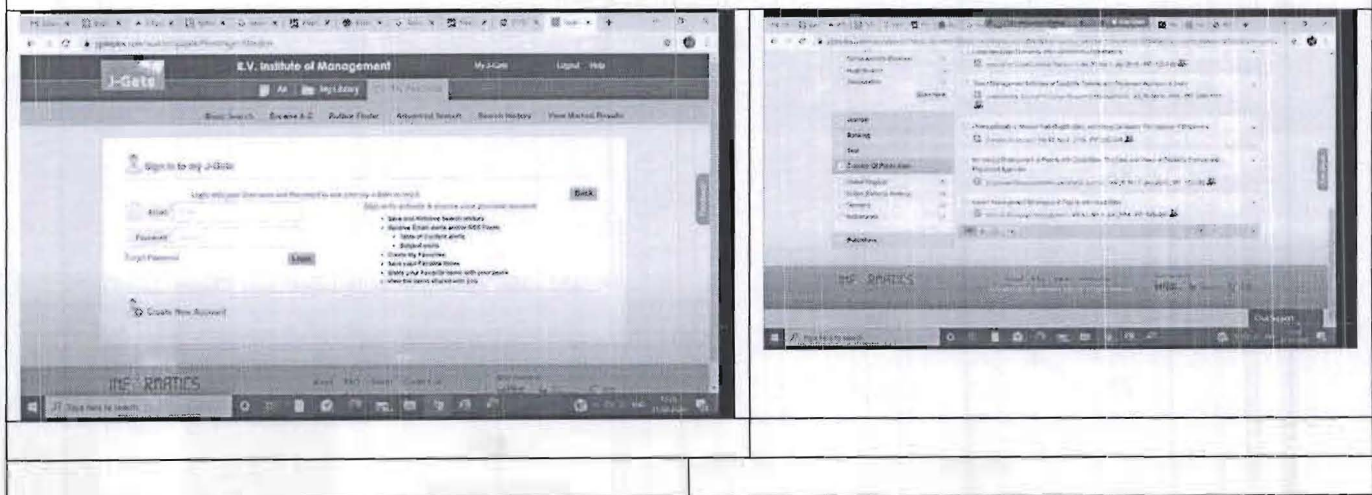

Constructing a search

- A student is working on the following paper
- It needs to find relevant articles
- How can I-Gate help in such a situation?

Results

R&D investment worldwide (2016 figures)

- Rough estimate of R&D investment, as a % GDP
- Japan 3.67%
- Sweden 3.60%
- Finland 3.48%
- USA 2.70%
- EU average 2.16%
- China 1.40%
- India ~1.00%

TraitBank (Integrated into EOL)

A searchable, comprehensive, open digital repository for organism traits, measurements and other information.

Conclusion

- Resources in general play a significant role in research
- Skilled LIS professional play a key role in assisting researchers
- Internet has revolutionised the way we work today
- Effective use of ICT and ICT enabled tools and technologies would take a long way in helping the user / researcher in
 - Web discovery
 - Federated search and so on..

Annexure 6

Detail Feedback

How will you rate the session of Mr. Ravi Shankar

70 responses

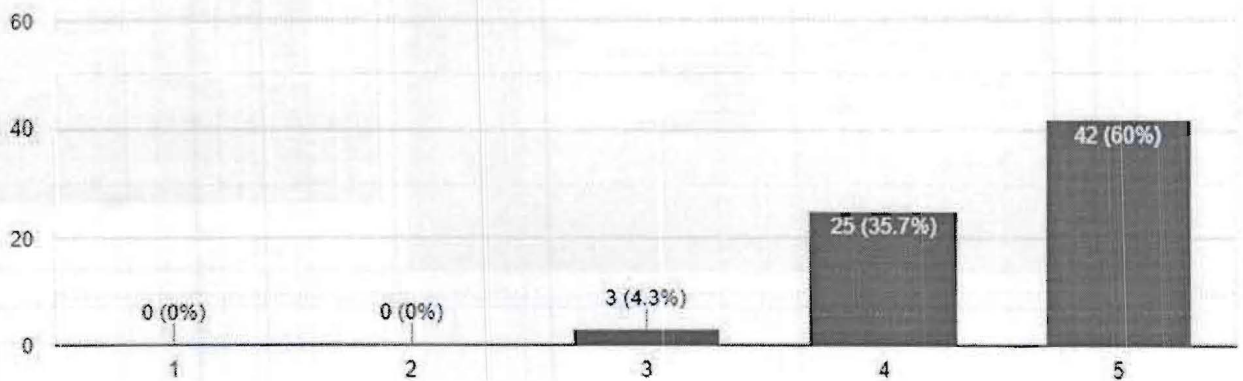

How will you rate the session of Mr Rajendra Babu

70 responses

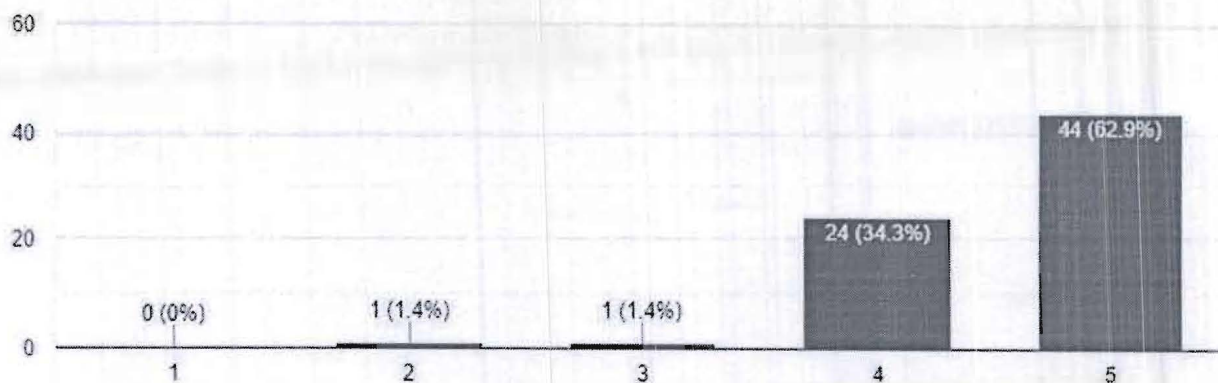

Please write your views about the organization and implementation of this FDP for one week in two lines.

70 responses

Good

Excellent

Very good

INTERESTED

Nice

It will be very helpful and will be waiting to join these amazing resource persons again.

Resource persons have shared the required information

It was informative.

Very well organized and informative and wish to be a part of its sessions in days to come.

Well done, As a sequel to the research methodology ,adds lots of value

Implement it.

It was really a good experience and the resource person covered the content very elaborate manner

Highly informative

NO

Excellent.

i have learn a lot about research as well as how to find about topic related to it. All guests are very prominent as well as learned. i want to join more and more events of this organisation.

Helpful

It would be great for us

Excellent

The organising board has done a great and wonderful jobs.

It was a nice session for students as well as for the research scholars for their future. Thank you

Good idea

Its good and topics are also good for FDP

Very informative and useful

Such wonderful programe.

Fdp for week but make it half day 10 to 1

Thank you for the wonderful session. It was very short. Request to conduct a week FDP on the same topic

Annexure 7

Certificate Copy Attached



RV Institute of Management®

Affiliated to Bengaluru
Central University

Approved by AICTE,
New Delhi. Accredited
by NAAC with 'A+' grade.



Rastreeya Sikshana Samithi Trust

R V Institute of Management

CA 17, 36th Cross, 26th Main, 4th 'T' Block, Jayanagar, Bangalore – 560 041

Ph: 080-26547048 Fax: 26654920; URL: rvim.edu.in Email: contact.rvim@rvei.edu.in

Certificate of Participation

This is to certify that,

Pathan Mujahed Khan

has successfully participated in the Workshop on “Knowledge Access Through J- Gate and Open resources in Management” organized by Centre for Knowledge Resources of R V Institute of Management, Bangalore on 11th September, 2020.

Dr. Purushottam Bung
Professor and Director
RV Institute of Management



**RV Institute of
Management®**

Affiliated to Bengaluru
Central University.

Approved by AICTE,
New Delhi. Accredited
by NAAC with 'A+' grade.



Rastreeya Sikshana Samithi Trust

R V Institute of Management

CA 17, 36th Cross, 26th Main, 4th 'T' Block, Jayanagar, Bangalore – 560 041

Ph: 080-26547048 Fax: 26654920; URL: rvim.edu.in Email: contact.rvim@rvei.edu.in



Certificate of Participation

This is to certify that,

Dr. Rajib Bhattacharya

has successfully participated in the Workshop on “Knowledge Access Through J- Gate and Open resources in Management” organized by Centre for Knowledge Resources of R V Institute of Management, Bangalore on 11th September, 2020.

Dr. Purushottam Bung
Professor and Director
RV Institute of Management



RV Institute of Management®

Affiliated to Bengaluru Central University

Approved by AICTE, New Delhi, Accredited by NAAC with 'A+' grade.



Rastreeya Sikshana Samithi Trust

R V Institute of Management

CA 17, 36th Cross, 26th Main, 4th 'T' Block, Jayanagar, Bangalore – 560 041

Ph: 080-26547048 Fax: 26654920; URL: rvim.edu.in Email: contact.rvim@rvei.edu.in

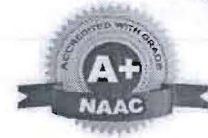

Certificate of Participation

This is to certify that,

Indwin E Joel

has successfully participated in the Workshop on “Knowledge Access Through J- Gate and Open resources in Management” organized by Centre for Knowledge Resources of R V Institute of Management, Bangalore on 11th September, 2020.

Dr. Purushottam Bung
Professor and Director
RV Institute of Management



RV Institute of Management®

Affiliated to Bengaluru Central University.

Approved by AICTE, New Delhi. Accredited by NAAC with A+ grade.



Rastreeya Sikshana Samithi Trust

R V Institute of Management

CA 17, 36th Cross, 26th Main, 4th 'T' Block, Jayanagar, Bangalore – 560 041

Ph: 080-26547048 Fax: 26654920; URL: rvim.edu.in Email: contact.rvim@rvei.edu.in

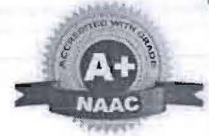

Certificate of Participation

This is to certify that,

SATINDER KAUR

has successfully participated in the Workshop on “Knowledge Access Through J- Gate and Open resources in Management” organized by Centre for Knowledge Resources of R V Institute of Management, Bangalore on 11th September, 2020.

Dr. Purushottam Bung
Professor and Director
RV Institute of Management

Timestamp	Email address	Name as required in Certificate	Mobile Number	Institute/organisation	Designation	City	State	Please write your views about the organization and implementation of this FDP for one week in two lines.	Your suggestions for improving future FDPs.
9/10/2020 10:46:59	priyajakhar0207@gmail.com	PRIYA JAIN	9108300728	RVIM	AP	bangalore	Karnataka	NO	NO
9/10/2020 10:57:14	anupama219@rediffmail.com	Ms. Anupama S. M	9739697154	R. V. INSTITUTE OF MANAGEMENT	LIBRARIAN	Bangalore	Karnataka	Nice seesion	No
9/10/2020 10:59:37	shivakumar.rvim@rvei.edu.in	Shivakumar H C	8147464481	RV Institute of Management	Assistant Librarian	Bengaluru	Karnataka	Nice	Nothing
9/11/2020 14:06:23	sweetabhi9988@gmail.com	MR. ABHISHEK NETAWAT	9929665306	V.M.O.U. KOTA	M.SC. CHEMISTRY	Udaipur	Rajasthan	Helpful	Nothing
9/11/2020 14:09:07	lalitha.rvim@rvei.edu.in	lalitha	7760857155	R V I M	LIBRARY ASST	BANGALORE	Karnataka	NICE	NOTHING
9/11/2020 14:17:51	siddaling@bideas.pcc.ac.in	Dr. Siddaling Talikoti	9886592502	BLDEA's ASP college of Commerce	Assistant Professor	Vijayapura	Karnataka	No comment	No comment
9/11/2020 14:18:05	unniramesh03@gmail.com	R Unni Krishnan	9444008909	St.Joseph's College Of Engineering	Be	chennai	tamil nadu	Good sessions	yes
9/11/2020 14:18:15	nadiminty.mahesh@gmail.com	Dr.N.MAHESH	08169233856	A C Patil College of Engineering, Management Studies & Research	PROFESSOR & HEAD	Navi Mumbai	Maharastra	INTERESTED	INFORMATIVE
9/11/2020 14:18:15	dharani511@gmail.com	Dr.K.Dharani Devi	9739455227	Don Bosco Institute of Management Studies and Computer Applications	Professor	Bangalore	Karnataka	Very good	Shorter time
9/11/2020 14:18:17	nitinnath303030@gmail.com	Neetin Nath	8840467553	Om uchha degree college	Teacher	Sant Ravidas Nagar	Uttar Pradesh	Excellent all information	Resources
9/11/2020 14:18:19	sk64939227@gmail.com	SATINDER KAUR	8872688538	BSK KHALSA COLLEGE SHRI CHAMKAUR SAHIB	ASSISTANT PROFESSOR	INDIA	PUNJAB	Useful	No
9/11/2020 14:18:40	sreevas91@gmail.com	Sreevas V T K	08861768227	Presidency College	Assistant Professor	Bangalore 24	Karnataka	Highly informative	To be continued such sessions
9/11/2020 14:18:46	razackabdullah88@gmail.com	Mr. ABDUL RAZACK K P	8592882001	JAMIA HAMDARD KANNUR CAMPUS	FACULTY	KANNUR	KERALA	It would be great for us	Include more sessions or days

9/11/2020 14:19:06	manuvirat885@gmail.com	Manohara N	8553673974	Jain(Deemed to be University)	Assistant Librarian	Bangalore	Karnataka	Good session	Very use full and informative session No suggestions
9/11/2020 14:19:11	sheeja.k@kristujayanti.com	Dr. Sheeja Krishnakumar	9845202845	Kristu Jayanti College	Asst Professor	Bangalore	Karnataka	Well organized program	No comments
9/11/2020 14:19:20	viswasanjit@gmail.com	Balaji Viswanathan	09487208995	Thiagarajar Polytechnic College	Head of Department (SS) / Mechanical Engineering	Salem	Tamil Nadu	Excellent and Very informative.	Nil
9/11/2020 14:19:24	ashwini@bdeaspcc.ac.in	Dr. Ashwini Yarnal	8792195863	BLDEA's A s Patil college of commerce MBA programme	Asst professor	Vijayapura	KARNATAKA	Excellent resource persons Worth attending	Pis make resource persons aware of technical aspects
9/11/2020 14:19:31	ibrahimajibola01@gmail.com	Ibrahim Ajibola Ogunkanmi	+2349034419857	Imam Malik College (an affiliate of University of Ilorin)	College Librarian	Ibadan	Oyo	Very nice presentations	Great effort from the organizers
9/11/2020 14:19:39	pushpashiraguppi@gmail.com	Pushpa V Shiraguppi	9880522387	Chetan Business School, Hubli	Asst librarian	Hubli	Karnataka	Excellent	It's good no suggestion
9/11/2020 14:19:40	priyankachoudhary73357@gmail.com	Priyanka choudhary	9685163978	Bhilai Mahila Mahavidyalaya Womens college in Bhilai, Chhattisgarh	Student	Bhilai	Chhattisgarh	Been quite good thank you	No
9/11/2020 14:19:43	mynamegautamde@gmail.com	Mr. GAUTAM DE	9476321767	UMA COMPUTER CENTRE, ASANSOL	COMPUTER TEACHER	ASANSOL	WEST BENGAL	Outstanding	All is well
9/11/2020 14:19:46	imtiazbair@yahoo.com	I IMTIAZ BAIG	8861969545	Bair & Associate	Talent Manager	Bangalore	Karnataka	Well done, As a sequel to the research methodology ,adds lots of value	More in this area for novice like me
9/11/2020 14:20:05	indwin@rediffmail.com	Indwin E Joel	9987532813	Prin. L.N Welingkar Institute of Management Development and Research	III Year. MHRDM	Mumbai	Maharashtra	Very informative and useful	Please share the session decks along with the recording for future reference
9/11/2020 14:20:12	majumderpriyanka1411@gmail.com	PRIYANKA MAJUMDER	8474063189	Bangalore University	Student	Bangalore	Karnataka	It was a nice session for students as well as for the research scholars for their future. Thank you	No

9/11/2020 14:21:48	anjana.padaki@manipalglobal.com	Anjana Padaki	9448948007	Manipal Academy of Banking	Academic Co-ordinator	Bangalore	Karnataka	Thank you for the wonderful session. It was very short. Request to conduct a week FDP on the same topic	Connectivity issues
9/11/2020 14:21:51	bmwshan15@gmail.com	Ms. Shanmuga priya Rajadurai	9791162593	Annamalai University	Research Scholar	CUDDALORE	Tamil Nadu	Excellent knowledge learning session	Great salute to RVIM
9/11/2020 14:21:53	Shekhara798@gmail.com	Shekhar Anand	9677845021	Annamalai University	Mechanical engineer	Deoghar	Jharkhand	It's a very valuable webinar me. Thank you	I want to learn more about open resource management
9/11/2020 14:21:55	saranibhaumik1982@gmail.com	SARANI BHAUMIK	8017834501	MAKAUT, WB	FACULTY	KOLKATA	WEST BENGAL	NA	NA
9/11/2020 14:22:15	alexbabumaliyaka@gmail.com	ALEX BABU	9496706124	Dr M V SETTY COLLEGE OF SOCIAL WORK MANGALORE	STUDENT	MANGALORE	KARNATAKA	THIS MAY PROVIDE MORE VALUABLE INFORMATION, AND MAY PROVIDE MORE SKILL TRAINING	NTG
9/11/2020 14:22:29	parmar.raman007@gmail.com	Ramandeep Kaur	6284141335	Kanya maha vidyalaya	Student	Jalandhar	Punjab	According to me, FDP is very important role in our life. and share this useful information about FDP is very good for student , because student Aware about .	It's very good .No suggestions from my side.
9/11/2020 14:22:48	jpreddy71@gmail.com	Dr Jayaprakash S	9341342688	Army institute of hotel management and catering technology	Librarian	Bengaluru	Karnataka	Fdp for week but make it half day 10 to 1	Like to attend
9/11/2020 14:22:57	tkjayaraj222@gmail.com	Dr. JAYARAJAN T K	9895696189	PAYYANUR COLLEGE, PAYYANUR	ASSISTANT PROFESSOR AND HOD	KANNUR	KERALA	Great	NA
9/11/2020 14:23:08	mdbilalccds2012@gmail.com	MD BILAL	9835652289	GALGOTIAS UNIVERSITY	STUDENT	PATNA	BIHAR	i have learn a lot about research as well as how to find about topic related to it. All guests are very prominent as well as learned. i want to join more and more events of this organisation.	no, thank you
9/11/2020 14:23:18	sureshamlis@gmail.com	SURESHA A D	8495017336	CHRIST Deemed to be University	Library Assistant	Bengaluru	Karnataka	Plagiarism erm	Content

9/11/2020 14:20:20	sanandpkl@gmail.com	Sanand Elayodath	9809667733	Central University of Tamil Nadu	Research Scholar	Thiruvavur	Tamil Nadu	It was really a good experience and the resource person covered the content very elaborate manner	Nil
9/11/2020 14:20:22	ptshubham610608@gmail.com	Shubham Dwivedi	8318888088	Raghunandan Singh PG College Sarwa Hardoi	Student	Hardoi	Uttar Pradesh	Very good session	Na
9/11/2020 14:20:24	bishamsingh99325@gmail.com	Mr. BISHAM SINGH	6006347018	GOVT. DEGREE COLLEGE UDHAMPUR	Student	Udhampur	Jammu and Kashmir	It was really very interesting for all of us.	I will develop it.
9/11/2020 14:20:29	pandeypratima55@gmail.com	Dr Pratima Pandey	9620618850	RJS Institute of Management Studies	Associate Professor	Bangalore	Karnataka	Resource persons have shared the required information	Conduct FDP on National Education Policy
9/11/2020 14:20:36	gurpreetsingh51634@gmail.com	Mr. Gurpreet Singh	9878280901	GNA University	Student Of B.Tech (Mechanical and Automation Engineering)	Hoshiarpur	Punjab	Good and informative	Please organized these in the evening.
9/11/2020 14:21:02	dr.a.narasimavenkatesh@gmail.com	Dr.A.Narasima Venkatesh	9110464380	R V Institute of Management	Associate Professor	Bangalore	Karnataka	Excellent.	Very Good.
9/11/2020 14:21:11	satyajit@bldeaspcc.ac.in	Satyajit Deginal	7204114448	BLDE	Assistant Professor	VIJAYAPURA	KARNATAKA	Very informative and helpful	Please provide option of joining FDP through Google Meet if possible.
9/11/2020 14:21:12	pathan77746@gmail.com	Pathan Mujahed Khan	8421932098	Swami Ramanand Teerth Marathwada University Nanded Maharashtra	Research Scholar	Nanded	Maharashtra	It will be better to organize for two week	Please make clarity of screen and connectivity
9/11/2020 14:21:15	namadevm8723@gmail.com	NAMADEV. K. MANG.	9844898482	Govt.First Grade College, Ainapur.	Assistant Professor.	Assistant	Karnataka	Implement it.	Yes
9/11/2020 14:21:29	savita@bldeaspcc.ac.in	Dr. Savita Kulkarni	09513397401	BLDEA'S ASP College of Commerce (A) MBA Program Vijayapur	Professor & Director	Vijapur	Karnataka	It was informative.	There is always a room for improvement ..extended time n expanded content.
9/11/2020 14:21:32	apradeep058@gmail.com	Pradeep Ahirwar	9516814811	I G ENGINEERING COLLEGE SAGAR, MP	STUDENT	SAGAR	Madhya Pradesh	Good ,for the student skill and knowledge development	Good for students as well as for teachers knowledge and skills development
9/11/2020 14:21:46	dileep.rvim@rvei.edu.in	DILEEP	8553276869	R V Institute of Management	Assistant Professor	Bangalore	Karnataka	Good	Excellent

9/11/2020 14:26:04	poojsant@gmail.com	Santosh M Biradar	7795505633	A. S. Patil college of commerce, Management department	Assistant professor	Vijayapur	Karnataka	Excellent	No comments.
9/11/2020 14:27:05	sykolat@rediffmail.com	Dr.Narayanawamy.S.Y	9036110406	KLEs,Bengaluru	Asst.Professor	Bengaluru	Karnataka	This webinar verymuch useful	Nice
9/11/2020 14:27:42	mukulsharma2098@gmail.com	Mukul Sharma	7900544332	Hero Moto corp.	QA	Saharanpur	Uttar Pradesh	It's good for us.	It's already good.
9/11/2020 14:27:45	balmohan@gmail.com	Mohanadoss Balaguru	+919849012727	HR Net Consultants Private Ltd	Principal Consultant & Director	Hyderabad	Telangana	Exceeded Expectations.	Excellently Planned and Implemented. Nothing more to suggest. Congratulations to Dr Bung, Dr Priya and Library Team.
9/11/2020 14:31:56	badami.sumangala@gmail.com	Prof.Sumangala Badami	8073797028	BLDEAS A.A.Patil college of commerce MBA programme, Vijaypur	Assistant Professor	Vijaypur	Karnataka	Good	No comments
9/11/2020 14:32:25	muragesh.octorich@gmail.com	Muragesh Y Pattanshetti	9739317408	BLDEA's, A.S.Patil college of commerce, MBA Programme	Associate Professor	Vijayapur	Karnataka	Excellent	Post covid please arrange such FDPs
9/11/2020 14:32:29	shwe1991@gmail.com	Shwetha Acharya.T	8095368993	East West College of Management	Assistant Professor	Bengaluru	KARNATAKA	Yes, that would be a wonderful idea to have a fdp on the similar topic oriented towards research	Timings was an issue today, it was to ld to log in at 10.30 but it started only at 11.00 Am
9/11/2020 14:35:19	gangadhar@bldaspcc.ac.in	Gangadhar Mamadapur	9740033706	A S Patil COLLEGE OF COMMERCE	Assistant professor	Vijayapur	Karnataka	This very relevant to today world	No suggestions
9/11/2020 14:35:57	devakhade4713@gmail.com	Mr.Devanand Ramchandra Khade.	9967530523	Dr.Ambedkar College of commerce & Economic Wadala.Mumbai-31	Library clerk.	Mumbai	Maharashtra	Nothing	No

9/11/2020 14:23:29	abhinavithm@gmail.com	Abhinav Yadav	8400821801	Dr. Om Prakash Institute Of Management And Technology	Student	Farrukhabad	Uttar Pradesh		
9/11/2020 14:23:56	sandeshbhatsmp@gmail.com	Sandesh Bhat	9008811647	RVIM	Student	Bangalore	Karnataka	It will be very helpful and will be waiting to join these amazing resource persons again.	In my opinion overall program was good. Thank you.
9/11/2020 14:23:59	sanjay@bldeaspc.ac.in	Dr Sanjay Subhas Hanagandi	9880132122	A S PATIL COLLEGE OF COMMERCE AUTONOMOUS MBA PROGRAM VIJAYAPUR	Assistant Professor	Vijayapur	Karnataka	Nicely organised, picked the right person for the topics	Nothing as such
								An extremely relevant and useful FDP for researchers, instructors, librarians and students	Please come up with similar FDPs on 1) Qualitative Data Analytics on R / Python Platform 2) Application of Six-Sigma & Balanced Score-Card Techniques in Finance / Accounts.
9/11/2020 14:24:07	rajib.learner@gmail.com	Dr. Rajib Bhattacharya	9007995333	ISB&M, Kolkata	Associate Professor	Kolkata	West Bengal		
9/11/2020 14:24:39	imranshkh29@gmail.com	Shaikh Imran Bashir	9987483501	IIMT	DIPLOMA ENGG	Mumbai	Maharashtra	Excellent	Yes i will
9/11/2020 14:25:12	sridevitr@rvce.edu.in	Dr T R Sridevi	9449517483	RV College of Engineering	Librarian	Bangalore	Karnataka	its good and topics are also good for FDP	-
9/11/2020 14:25:43	shobharanimunireddy@gmail.com	SHOBHARAN I	9994751731	ZEE SCHOOL, HOSUR	LIBRARIAN	Hosur	Tamil nadu	I felt about the organization Awesome and very beneficial.	Updating the knowledge
9/11/2020 14:25:47	sarita.murmunew@gmail.com	Sarita Murmu	9304760501	Cambridge Institute of Technology, Ranchi	Asst.Professor	Ranchi	Jharkhand	Very well organized and informative and wish to be a part of its sessions in days to come.	Perfect.
9/11/2020 14:25:57	chidanand@bldeaspc.ac.in	Dr Chidanand G Byahatti	9845651235	BLDEA's A S Patil College of Commerce (Autonomous), Vijayapura	Assistant Professor	Vijayapura	Karnataka	Good	No improvement required

9/11/2020 14:36:02	zssailo84@gmail.com	Mr. Zirsangliana Sailo	9862842365	Mizoram College of Nursing (MCON), Department of Hospital and Medical Education, Government of Mizoram.	College Librarian	Aizawl	Mizoram	The organising board has done a great and wonderful jobs.	If the fdp timing can be change to 6:30pm - 8:30 pm every night, we can focused more on each programme. We need to give priority to our works during working hours.
9/11/2020 14:36:36	prassuprabhas@gmail.com	PRASANNAK UMAR DK	9972798744	Sapthagiri institute of medical science and research centre	Asst.librarian	Banglore	Karnataka	Good	U can take some current situation topics like technology
9/11/2020 14:48:32	kirankakade2025@gmail.com	Dr. KIRAN SHRIMANT KAKADE	7021191335	Guru Nanak Institute of Management Studies Mumbai	Assistant Professor	Mumbai	Maharashtra	Good	Nil
9/11/2020 15:08:41	laxman@bdeaspcc.ac.in	Laxman Suresh Pawar	9742194303	Bidea A S Patil College Of Commerce MBA department	Assistant professor	vijayapura	Karnataka	It's good	No
9/11/2020 15:19:52	soumyatungal123@gmail.com	soumya Tungal	7760027612	BLDEA's degree college jamkhandi	Lecturer	JAMKHANDI	Karnatak	Such wonderful programe.	Nothing more to tell well organized
9/11/2020 16:15:34	mahantesh@bdeaspcc.ac.in	Mahantesh Kanamadi	9886247905	A S Patil College of Commerce, MBA Programme	Assistant Professor	Vijayapur	Karnataka	Good idea	Nil

Attendee Report
 Report Generated: 9/24/2020 16:27

Max Concurrent
 Views

Topic	Webinar ID	Actual Start Time	Actual Duration (minutes)	# Registered	# Cancelled	Unique Viewers	Total Users	Max Concurrent Views	
WORKSHOP ON KNOWLEDGE ACCESS THROUGH J-GATE AND OPEN RESOURCES IN MANAGEMENT	945 0932 3049	9/11/2020 10:26		244	271	0	117	380	68

Host Details

Attended	User Name (Origir Email)	Join Time	Leave Time	Time in Sessio	Country/Region Name
Yes	Priya Jain (Directo director.rvim@rvei.ec	9/11/2020 10:26	9/11/2020 14:29	244	India

Panelist Details

Attended	User Name (Origir Email)	Join Time	Leave Time	Time in Sessio	Country/Region Name
Yes	Ms. Anupama S Manupamasm.rvim@rv	9/11/2020 12:27	9/11/2020 13:02	36	India
Yes	Ms. Anupama S Manupamasm.rvim@rv	9/11/2020 14:12	9/11/2020 14:25	13	India
Yes	Ms. Anupama S Manupamasm.rvim@rv	9/11/2020 13:09	9/11/2020 13:10	2	India
Yes	Ms. Anupama S Manupamasm.rvim@rv	9/11/2020 10:35	9/11/2020 12:22	107	India
Yes	Ms. Anupama S Manupamasm.rvim@rv	9/11/2020 13:23	9/11/2020 13:39	17	India
Yes	Ms. Anupama S Manupamasm.rvim@rv	9/11/2020 13:39	9/11/2020 14:12	33	India
Yes	Ms. Anupama S Manupamasm.rvim@rv	9/11/2020 13:02	9/11/2020 13:06	5	India
Yes	Ms. Anupama S Manupamasm.rvim@rv	9/11/2020 13:07	9/11/2020 13:09	2	India
Yes	Dr. Purushottam Ebunguas@gmail.com	9/11/2020 14:01	9/11/2020 14:23	23	India
Yes	Dr. Purushottam Ebunguas@gmail.com	9/11/2020 11:05	9/11/2020 13:59	175	India
Yes	Ms. Lalitha Lalitha.rvim@rvei.edt	9/11/2020 13:27	9/11/2020 13:39	13	India
Yes	Ms. Lalitha Lalitha.rvim@rvei.edt	9/11/2020 14:12	9/11/2020 14:24	12	India
Yes	Ms. Lalitha Lalitha.rvim@rvei.edt	9/11/2020 13:13	9/11/2020 13:28	15	India
Yes	Ms. Lalitha Lalitha.rvim@rvei.edt	9/11/2020 13:39	9/11/2020 14:12	33	India
Yes	Ms. Lalitha Lalitha.rvim@rvei.edt	9/11/2020 10:26	9/11/2020 13:02	156	India
Yes	Ms. Lalitha Lalitha.rvim@rvei.edt	9/11/2020 13:09	9/11/2020 13:10	2	India
Yes	Ms. Lalitha Lalitha.rvim@rvei.edt	9/11/2020 13:02	9/11/2020 13:06	5	India
Yes	Ms. Lalitha Lalitha.rvim@rvei.edt	9/11/2020 13:07	9/11/2020 13:09	2	India
Yes	Dr. Rajendra Babu hrajendra.babu@gma	9/11/2020 10:55	9/11/2020 11:00	5	India
Yes	Dr. Rajendra Babu hrajendra.babu@gma	9/11/2020 11:27	9/11/2020 11:30	3	India
Yes	Dr. Rajendra Babu hrajendra.babu@gma	9/11/2020 10:41	9/11/2020 10:55	15	India
Yes	Dr. Rajendra Babu hrajendra.babu@gma	9/11/2020 12:20	9/11/2020 14:23	124	India
Yes	Dr. Rajendra Babu hrajendra.babu@gma	9/11/2020 11:51	9/11/2020 11:55	4	India
Yes	Mr. Ravi ravishankarbs04@gm	9/11/2020 10:52	9/11/2020 10:53	1	India
Yes	Mr. Ravi ravishankarbs04@gm	9/11/2020 11:14	9/11/2020 12:49	96	India
Yes	Mr. Ravi ravishankarbs04@gm	9/11/2020 10:35	9/11/2020 10:43	8	India
Yes	Mr. Ravi ravishankarbs04@gm	9/11/2020 11:13	9/11/2020 11:14	1	India
Yes	Mr. Ravi ravishankarbs04@gm	9/11/2020 10:53	9/11/2020 11:13	21	India
Yes	Mr. Ravi ravishankarbs04@gm	9/11/2020 10:47	9/11/2020 10:51	5	India
Yes	Mr. Shiv Kumar Shivakumar.rvim@rv	9/11/2020 13:09	9/11/2020 13:10	2	India
Yes	Mr. Shiv Kumar Shivakumar.rvim@rv	9/11/2020 13:13	9/11/2020 13:35	23	India



Webinar

on

Research Methodology

Date: 4 th June'2020	Venue: Seminar Hall
Time: 11.00 am to 1.00 pm	Sem / Year /Group : II & IV Semester Students, RVIM Students Pursuing Master's Degree in Economics, Bangalore University, Bangalore
No. of Participant: 240	Event Coordinators: Prof. Pavithra S T Dr. N Suresh Prof. Uma Sharma

Objectives

- Provide students in depth understanding of the methods of research used in the academic and corporate world
- Understanding of the ways of applying research methods in the business situations
- Use of research results for making business decisions

Agenda/Flow of the Event

- Introduction to Research and Research Methodology, Types, Process, Research Design
- Sampling Techniques, Data collection Methods, Statistical Techniques used for Analysis
- Report Writing

Brief Profile of the Resources Person: Dr. N S Viswanath

Dr. N S Viswanath He is the Hon. Director General (Research) of M.P. Birla Institute of Management; Associate Bharatiya Vidya Bhavan, Bengaluru. He is the coordinator of Department of Economics of Bengaluru Central University (BCU). He was the Director and founder Principal of the M.P.Birla Institute of Management for the period 1999-2003 & from 2013 to 2018. Besides, he was Resident Director, Bhavan-Marshall Institute of Management (2005 to 2011) & Resident Director of Ohio-Manipal School of Business (2003 to 2005), Bengaluru. At present, he is the Editor-in-Chief, Dharana- Bhavan's International Journal of Business. He was Professor of Marketing and Academic Coordinator at M.S. Ramaiah Institute of Management and at Maharishi Institute of Management, Bangalore. He was an Associate Professor at Mudra Institute of Communications, Ahmedabad (MICA). He has successfully guided twelve scholars for PhD in Management & continues to guide six more scholars. He has had an assignment as Assistant General Manager at KSAM Board. It was during this period spanning over two decades he was mercurially involved in the preparation of several research project reports for the World Bank, Commercial Banks and related institutions. He was largely responsible for the evolution of Market Intelligence System (MIS) in collaboration with National Informatics Centre (NIC). He has over seventy papers to his credit in refereed journals. He has been enlisted as an expert at International Trade Centre (ITC), Geneva and in Asia's Who's Who: Men and Women of Achievements. He has a PhD in Economics preceded by Masters' degrees in Statistics, Economics and Agri Business (Agricultural Marketing Management). In addition, he is specialized in Training and Development and Managerial Skills.

Outcome Achieved/ Attained :

- ✓ Research and Research Methodology, Types, Process, Research Design
- ✓ Sampling Techniques, Data collection Methods, Statistical Techniques used for Analysis
- ✓ At the end they Q & A session happened and students cleared their queries with the resource person

Feedback of the Webinar

The subject area of the webinar was relevant

178 responses

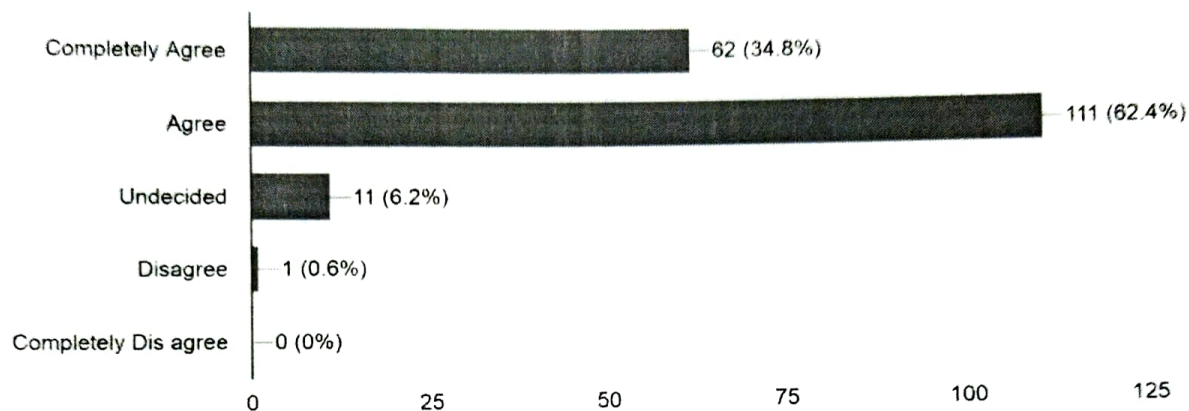

The resource person of the webinar was informative

178 responses

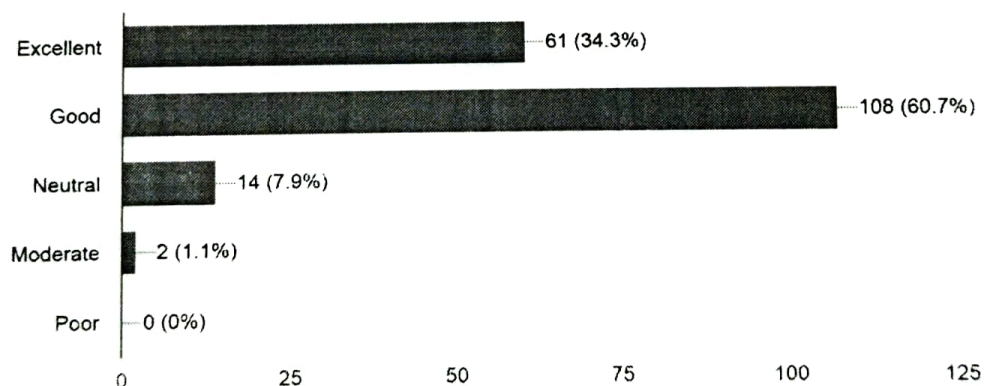

Topics covered in the webinar has provided a better understanding of research methods

178 responses

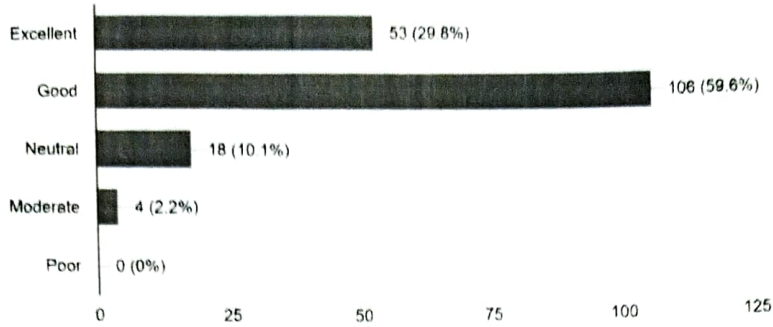

Research methods learnt in the webinar can be applicable while completing dissertation or internship reports.

177 responses

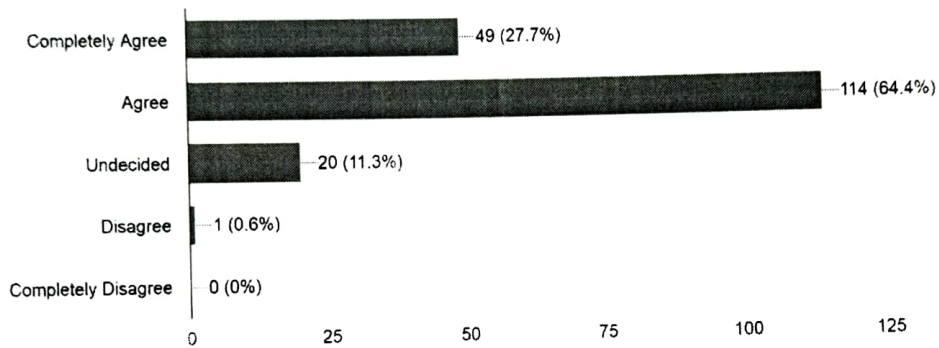

Participants list

Airtel 11:58 AM 69%

Close Participants (240)

Search

- Sushma Heroorkar (me)
- Aishwarya.R.K
- Anoop Patil
- Pavithra S T (Host)
- Akshatha Bopaiah M
- Architha. R
- S N
- Akshatha K M
- Arpita Gour
- Uday KV
- Akshatha LV
- Arpitha S
- Aakanksha Rao B.S
- Akshatha M L
- Asha Verma
- Abhilash N A
- Alok Hegde
- Ashwathi S
- Abhisek Saha
- Amal Tom
- Athri
- abhishek abhi
- Amar nath
- Avinash Agarwal
- Abhishek Jagadish Joshi
- Amogh N
- Ayushi Anand
- ankitha manjunath
- B. Vasavi

Invite

	8:00		8:00		8:00
	8:00		8:00		8:00
	8:00		8:00		8:00
	8:00		8:00		8:00
	8:00		8:00		8:00
	8:00		8:00		8:00
	8:00		8:00		8:00
	8:00		8:00		8:00
	8:00		8:00		8:00
	8:00		8:00		8:00
	8:00		8:00		8:00
	8:00		8:00		8:00
	8:00		8:00		8:00
	8:00		8:00		8:00
	8:00		8:00		8:00
	8:00		8:00		8:00
	8:00		8:00		8:00
	8:00		8:00		8:00
	8:00		8:00		8:00
	8:00		8:00		8:00
	8:00		8:00		8:00
	8:00		8:00		8:00
	8:00		8:00		8:00
	8:00		8:00		8:00
	8:00		8:00		8:00
	8:00		8:00		8:00
	8:00		8:00		8:00
	8:00		8:00		8:00
	8:00		8:00		8:00
	8:00		8:00		8:00
	8:00		8:00		8:00
	8:00		8:00		8:00
	8:00		8:00		8:00
	8:00		8:00		8:00
	8:00		8:00		8:00
	8:00		8:00		8:00
	8:00		8:00		8:00
	8:00		8:00		8:00
	8:00		8:00		8:00
	8:00		8:00		8:00

Prof. Pavithra S T
 Dr. N Suresh
 Prof. Uma Sharma
 Event Coordinators

Pavithra S T
N Suresh

R. V. Institute of Management
 Director
 Jayanagar, Bangalore - 560041



Rashtriya Sikshana Samithi Trust

RV Institute of Management

Permanently Affiliated to Bengaluru Central University

Approved by AICTE New Delhi, Recognised by Govt. of Karnataka

**Report on STUDENT DEVELOPMENT PROGRAMME
IIC – Innovation Ambassador
Online sessions
Conducted by RV. Institute of Management, Bangalore**

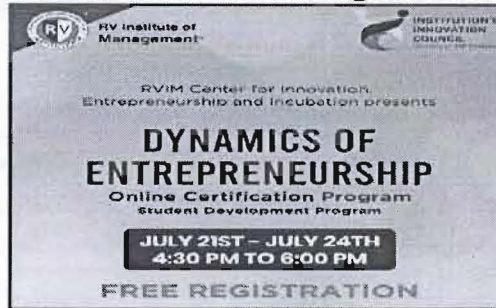

RV Institute of Management, Centre for Entrepreneurship, Innovation and Incubation organised the Student development Programme -A four-day series aimed at informing and inculcating new entrepreneurial methods of Thinking and encouraging Entrepreneurial Innovation. The programme was conducted from 21st July to 24th July' 2020.

The Session were conducted online for registered participating students. Resource person for the session were IIC Innovation Ambassadors, Faculty at RVIM.

OBJECTIVES:

Student development Programme organised and conducted by RV Institute of Management, Centre for Entrepreneurship, Innovation and Incubation. A four-day series aimed at informing and inculcating new entrepreneurial methods of Thinking and innovation.

BENEFITS:

The Session provides an understanding into new set of concepts and practises that are relevant to today's start-ups.

The sessions help participate in a dialogue on the topics of building new ideas that are well thought out to involve innovativeness.

The session caters to budding or aspiring entrepreneurs and also to any youth who wants to train as a better management practitioner.





SESSION 1: DESIGN THINKING FOR ENTREPRENEURS

DATE: JULY 21ST, 2020

RV Institute of Management[®]

DESIGN THINKING FOR ENTREPRENEURS

Dr. Purushottam Bung
Professor and Director,
R V Institute of Management

21ST JULY 2020

NO OF STUDENTS: 408

NO OF FACULTIES: 04

RESOURCE PERSON: 01

TOPIC: DESIGN THINKING FOR ENTREPRENEURS

SESSION TAKEAWAY:

- **THE SESSION GAVE AN UNDERSTANDING IN THE DESIGN THINKING PROCESS**
- **APPLICATION OF DESIGN THINKING IN THE IDEA GENERATION IN THE ENTREPRENEURIAL PROCESS**
- **IDEATION THROUGH THE SIX STAGES OF DESIGN THINKING**
- **OUTCOME OF THE IDEA IN A DESIGN THINKING PROCESS IS MORE WELL EVALUATED.**



SESSION 2: INTELLECTUAL PROPERTY FOR ENTREPRENEURS

DATE: JULY 22ND , 2020

RV Institute of Management[®]

IPR FOR ENTREPRENEURS

Student Development Program

Prof. Chandran A
Asst. Professor ,
R V Institute of Management

22ND JULY 2020

LAW

NO OF STUDENTS: 408

NO OF FACULTIES: 04

RESOURCE PERSON: 01

TOPIC INTELLECTUAL PROPERTY RIGHTS FOR ENTREPRENEURS

SESSION TAKEAWAY:

- **THE SESSION PROVIDED ALL THE BASIC INFORMATION ON IP CONCEPT. PR POLICY FOLLOWED IN INDIA.**
- **APPLICATION OF IP PROTECTION FOR THE ENTREPRENEURIAL IDEAS-NECESSITY AND ITS IMPORTANCE IN RECENT START-UP SYSTEM**
- **IP AND ITS VARIOUS FORM SUCH AS COPYRIGHT, PATENT WAS DISCUSSED**
- **BENEFITS AND PROTECTION OFFERED TO ENTREPRENEURS UNDER THE IPR POLICY OF INDIA.**



SESSION 3: ENTREPRENEURS AND EFFECTUATION

DATE: JULY 23RD , 2020

RV Institute of Management[®]

ENTREPRENEURSHIP & EFFECTUATION

Student Development Program

Prof. Uma Sharma
Asst. Professor ,
R V Institute of Management

23RD JULY 2020

NO OF STUDENTS: 408

NO OF FACULTIES: 04

RESOURCE PERSON: 01

TOPIC EFFECTUATION FOR ENTREPRENEURS

SESSION TAKEAWAY:

- **INTRODUCTION TO CONCEPT OF EFFECTUATION – TAKING THE ‘IDEA’ TO MARKET.**
- **APPLICATION OF EFFECTUATION THE ENTREPRENEURIAL IDEAS-THE NEED TO ADAPT THIS METHOD OF IDEA THIS ENSURES IDEA IS DRIVEN WITH CUSTOMER CENTRIC APPROACH.**
- **DISCUSSION OF CASE STUDY WHERE EFFECTUATION WAS TO MODIFY THE IDEA GENERATED.**



SESSION 04

DATE:24TH JULY'2020

RV Institute of Management[®]

START-UPS ECOSYSTEM IN INDIA

Student Development Program

Prof. Rashmi Shetty
Asst. Professor ,
R V Institute of Management

24TH JULY 2020

NO OF STUDENTS: 408

NO OF FACULTIES: 04

RESOURCE PERSON: 01

TOPIC START-UP ECOSYSTEM FOR ENTREPRENEURS IN INDIA

SESSION TAKEAWAY:

- THE SESSION BEGAN WITH AN OVERVIEW OF THE START-UP ECOSYSTEM IN INDIA
- DISCUSSION ON THE VARIOUS SCHEMES AND POLICIES OF THE STAR UP INDIA PROGRAMME IN INDIA.
- SHOWCASE AND DISCUSSION OF THE SUCCESSFUL START-UPS IN INDIA.
- FUNDING OPTIONS AND FUNDING AGENCIES AVAILABLE FOR START-UPS IN INDIA'
- CASE STUDY BASED DISCUSSION ON THE VARIOUS ECO SYSTEM SUPPORT OFFERED AT VARIOUS STAGES OF THE VENTURE GROWTH

TAKE AWAY FOR STUDENTS FROM THE PROGRAMME AND FEEDBACK

- PARTICIPATING STUDENTS ACTIVELY ENGAGED IN COMPREHENDING AND UNDERSTANDING CURRENT CONCEPTS AND POLICES FOR START-UPS IN INDIA
- CERTIFICATES WERE ACHIEVED FOR ALL PARTICIPATING STUDENTS



Rashtriya Sikshana Samithi Trust

RV Institute of Management[®]

Permanently Affiliated to Bengaluru Central University

Approved by : AICTE, New Delhi ; Recognised by : Govt. of Karnataka
