



RASHTREEYA SIKSHANA SAMITHI TRUST

**R V INSTITUTE OF MANAGEMENT**  
CA 17, 26 Main, 36th Cross, 4th T Block, Jayanagar  
Bengaluru, Karnataka 560 041



Criteria 6

<b>FDP</b> on <b>EMERGING TECHNOLOGIES- WAY FORWARD</b> (In association with RV SKILLS)	
Date: 3 <sup>rd</sup> Aug to 8 <sup>th</sup> Aug 2020	Venue: Zoom webinar
Time: 11 am to 1 pm	Event : Webinar
No. of Participant: 171	Event Coordinator: Dr. Santhosh M Prof. Reddy Prof Dileep Prof. Priya Jain Ms. Vidya (RV SKILLS)
<b>Objectives</b> <ul style="list-style-type: none"><li>- To gain deeper understanding of the concept of Artificial Intelligence</li><li>- To identify the future of block chain in India and world.</li><li>- To understand the concept of IOT and its opportunities and challenges and solutions.</li><li>- To analyze the importance of Robotics Process Automation in today's world</li><li>- To examine the future of Cryptocurrency.</li><li>- To have knowledge about the cloud computing</li></ul>	
<b>Agenda/Flow of the Event</b> <ul style="list-style-type: none"><li>• 3<sup>rd</sup> Aug- Artificial intelligence by Mr. Chinmaya Mishra, Lead Data Scientist, Microsoft</li><li>• 4<sup>th</sup> Aug- Future of Block Chain by Mr. Stanly Johnson, Block Chain developer and researcher</li><li>• 5<sup>th</sup> Aug- IOT- opportunities, challenges and solutions by Mr Raghu Venkataramana, Director- Qantom Software Pvt. Ltd.</li><li>• 6<sup>th</sup> Aug- Cryptocurrency by Mr. Stanly Johnson, Block Chain developer and researcher</li><li>• 7<sup>th</sup> Aug- Robotic Process Automation by Mr. Gulshan kumar, programmer Analyst, Inventys Technology pvt. Ltd.</li><li>• 8<sup>th</sup> Aug- Travel in the cloud by Mr. Mahesh P, Infrastructure Engineer Architect, Data management startup.</li></ul>	
<b>Outcome Achieved/ Attained:</b> <ul style="list-style-type: none"><li>- Mr. Chinmaya Mishra started the program on the first day and explained a clear distinction</li></ul>	



between Artificial intelligence, machine Learning and Deep learning. He used CRISP Data Mining Model to solve business problems. He described the use of analytics for recommendations.

- On the second day Mr. Stanly Johnson started the session with the article on Bitcoin: A Peer to Peer Cash System. He explained in detail how block chain functions and what will be the future of block chain.
- Third day session was taken by Mr. Raghu on the topic IOT. He briefly explained what is IOT, its history, opportunities, challenges and solutions. He also told about various application domains of IOT. He showed some videos on the application of IOT for better understanding of participants.
- Fourth day session was taken over by Mr Stanly again on the topic Cryptocurrency. He explained briefly how cryptocurrency works and what is the future of it. He also explained various types of cryptocurrency and motivated audience to invest in same. What are the security points during investment were also very clearly explained by him.
- Fifth day the session was taken over by Mr. Gulshan Kumar on Robotics Process Automation. He explained what is RPA, how it works and various tools of RPA like Blue Prism, Automation Anywhere, UiPath etc. he also explained what should be the selection criterion for the tool.
- Last day session was taken by Mr. Mahesh on Cloud computing. He started the session with quote Travel in the cloud like you travel on the road; travel in the cloud is not just reaching the target but is an experience that you would be excited. He explained about storage of data on the cloud, how it works and various myths associated with it

**Feedback & Coordinator Comment:**

The entire program was very well received by all the participants. All the participants appreciated the program and were happy to have deeper knowledge on emerging trends. During the sessions participants had a chance to know how various new technologies works and how they can be used in our daily life to solve various problems.

**Event Coordinator(s)**

N. N. Reddy (Prof. Nagasubha Reddy)  
Upendra (Dr. Santosh M)  
Dileep (Prof. Dileep)  
Priya (Prof. Priya)

~~Director~~



Annexure 1	Proposal / Approval	Attached
Annexure 2	Circular / Brochure of the event	Attached
Annexure 3	Brief profile of the speaker	Attached
Annexure 4	Attendees list	Attached
Annexure 5	Photo Gallery	Attached
Annexure 6	Detail Feedback (if required)	attached
Annexure 7	Certificate copy	attached



Annexure 2  
Circular / Brochure of the event

Brochure



**RV Institute of Management**  
Approved by Government of Karnataka  
Approved by AICTE  
Approved by ISO 9001  
Approved by ISO 27001  
Approved by ISO 14001  
Approved by ISO 45001  
Approved by ISO 50001  
Approved by ISO 55001  
Approved by ISO 63001  
Approved by ISO 64001  
Approved by ISO 65001  
Approved by ISO 66001  
Approved by ISO 67001  
Approved by ISO 68001  
Approved by ISO 69001  
Approved by ISO 70001  
Approved by ISO 71001  
Approved by ISO 72001  
Approved by ISO 73001  
Approved by ISO 74001  
Approved by ISO 75001  
Approved by ISO 76001  
Approved by ISO 77001  
Approved by ISO 78001  
Approved by ISO 79001  
Approved by ISO 80001  
Approved by ISO 81001  
Approved by ISO 82001  
Approved by ISO 83001  
Approved by ISO 84001  
Approved by ISO 85001  
Approved by ISO 86001  
Approved by ISO 87001  
Approved by ISO 88001  
Approved by ISO 89001  
Approved by ISO 90001

*Go, change the world*

**RV Institute of Management**  
In association with  
**RV-SKILLS**  
Is Organizing an FDP On

**“Emerging Technologies- A WAY FORWARD”**  
From 3<sup>rd</sup> August to 8<sup>th</sup> August, 2020  
11.00 am to 1.00 pm



**SPEAKERS**



**Chinmaya Mishra**  
Lead Data Scientist Microsoft  
(Topic- Artificial Intelligence)



**Gulshan Kumar**  
Programmer Analyst  
Inventys Technology Pvt. Ltd  
(Topic - Robotic Process Automation)



**Stanly Johnson**  
Block Chain Developer and Researcher  
(Topic-Future of Block Chain and  
Crypto Currency)



**Raghu Venkataramana**  
Director, Qantum Software Pvt. Ltd.  
(Topic-IOT- Opportunities,  
Challenges and Solutions)



**Mr. Mahesh P**  
Infrastructure Engineer Architect  
A Data Management Startup  
(Topic- Travel in the Cloud)

**Moderator**



**Mr. Venkatesh Prasad**  
Professor and Director,  
RV SKILLS, Bangalore



**Dr. Purushottam Bung**  
Professor and Director  
RV Institute of Management, Bangalore

Participation Fee: Rs. 500/- Faculty / Scholars Rs. 200/- Students

Once you make the payment please register through the google form link  
<https://forms.gle/E78e5Bh45vqfMriv9>

E-certificates will be provided to all the registered participants

**Payment Details:**

Name: Director RV Institute of Management  
Bank Name: ICICI Bank, 9th Block Branch,  
A/C No.: 029901002291  
IFSC Code: ICIC000299  
MICR Code: 560229022  
UPI ID : directorrvim@icici



**For further clarification please contact:**

Dr. Santhosh @ 9739945333  
Prof. Reddy @ 9845492336  
Prof. Dileep @ 8553276869  
Prof. Priya @ 9108300728  
Ms. Vidya @ 7349389666

businessanalyst.fdp2020@gmail.com



**Annexure 3**  
**Brief profile of the speaker**

**Brief Profile of the Resources Persons**

**1. Mr Raghu Venkataramana, Director- Qantom Software Pvt. Ltd.**



- Mr. Raghu is the founder and CEO of Qantom Software Private Limited.
- He has done is post graduate in IOT from Birla Institute of Technology and Science, Pilani.
- After working on various technologies like VOIP, Networking, IP Phone etc now he is completely focused on building products and frameworks for IOT Experience.
- Till now he has created many IOT products like prototype of an IOT framework which allows for easy discovery and configuration of IOT end points; a framework to manage unit and automated tests directly from spreadsheets; created a utility which helped Quick test users to manage the descriptive repositories and many more.
- Mr. Raghu is very strong in core java and object oriented development. He is expert in SQA and test automation.
- In his initial years of professional career he has worked in the fields of graphic design and turnkey printing and has build his entrepreneurial skills.

**2. Mr. Chinmaya Mishra, Lead Data Scientist, Microsoft**



- Mr. Chinmaya is the enthusiastic learner in Artificial Intelligence field with Machine Learning and



Deep learning skills.

- Currently he is leading data science team consists of threat intelligence, hunting, Insider risk and compliance.
- He is a sensible team leader with leading midsize teams and have good record of working closely with cross functional teams across security, operations, marketing and supply chain.
- His passion is mentoring various data science aspirants.
- He loves to explore more in cyber security and Engineering analytics which brought him to work for Fortune 500 companies like Honeywell, Rockwell Collins, Collins Aerospace and Microsoft.
- He has worked on many critical projects like connected ecosystem, cyber security and many more.
- He got an exposure of business aspects of Artificial Intelligence while doing analytics in Retail Finance at Bajaj Auto Finance.
- He is also specialized in Big data technology like Hadoop, R, Python, PYSpark SAS and SPSS

**3. Mr. Stanly Johnson, Block Chain developer and researcher**

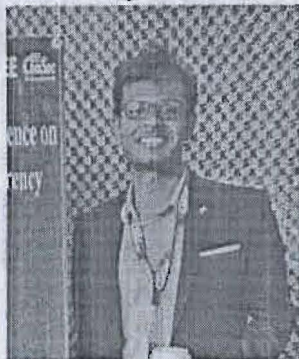

- Mr. Stanly Johnson is a software engineer passionate about developing solutions that make a dent in the universe.
- He has worked on medical block chain platforms; IOT based supply chain solutions, crypto exchanges and is an early contributor to the Corda Enterprise block chain platform.
- He is a certified block chain architect and was one of the first employees of Serventire Global. India's first block chain acquisition.
- He currently works as a block chain developer for a leading crypto currency exchange in South Korea

**4. Mr. Gulshan kumar, programmer Analyst, Inventys Technology pvt. Ltd.**

(Full CV attached)

**5. Mr. Mahesh P, Infrastructure Engineer Architect, Data management startup.**

(Full CV attached)



# Annexure 5

## Photo Gallery

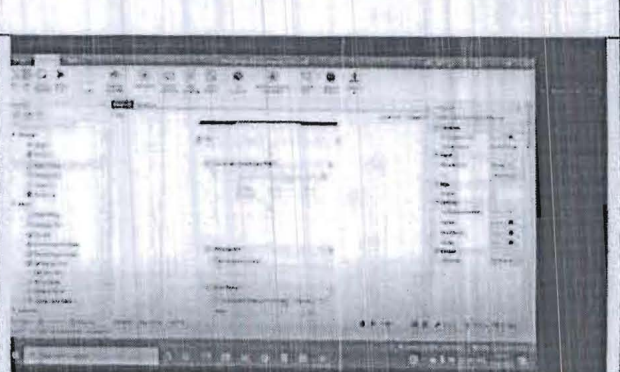
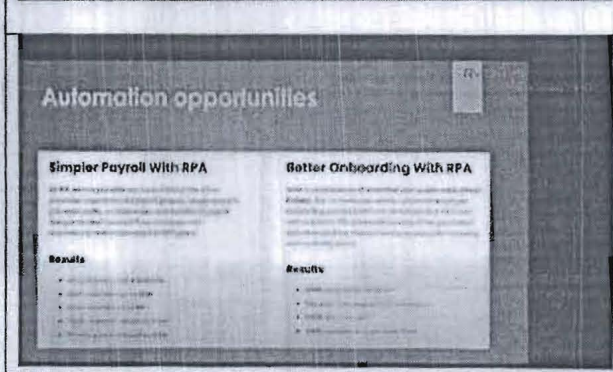
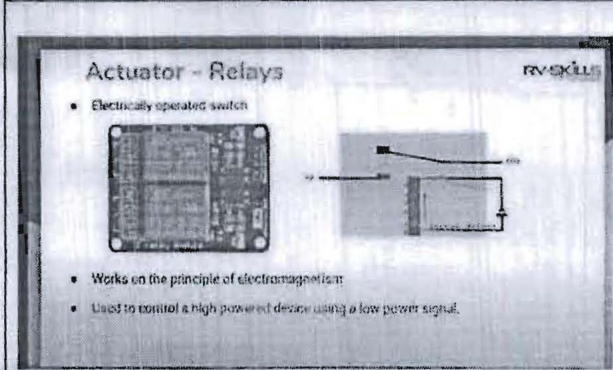
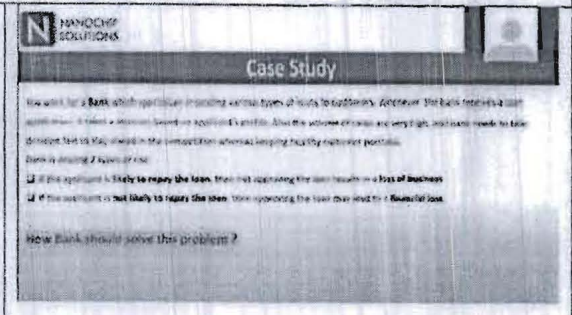
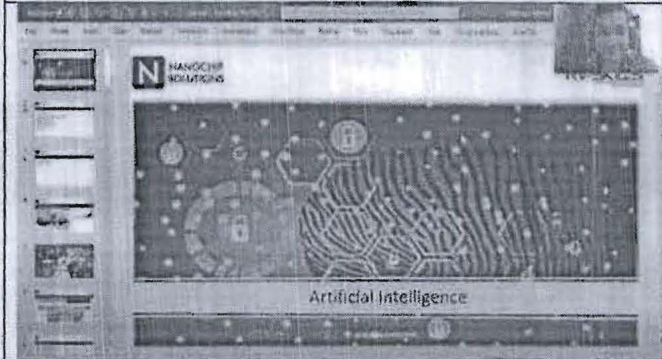



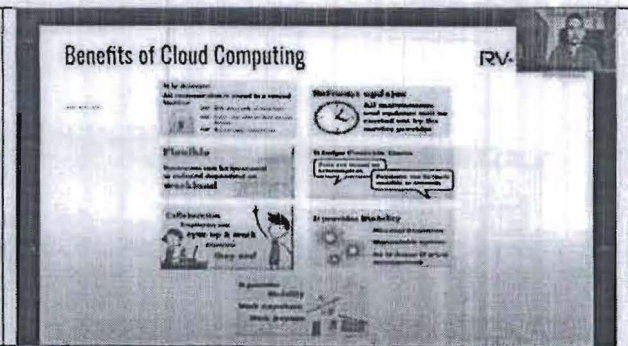
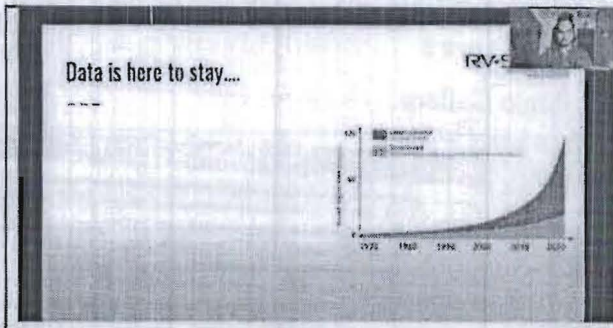

**Annexure 6**

**Detail Feedback**

Overall rating of the resource person considering command on the subject matter and delivery : Mr.Chinmaya Mishra,Topic- Artificial Intelligence

82 responses

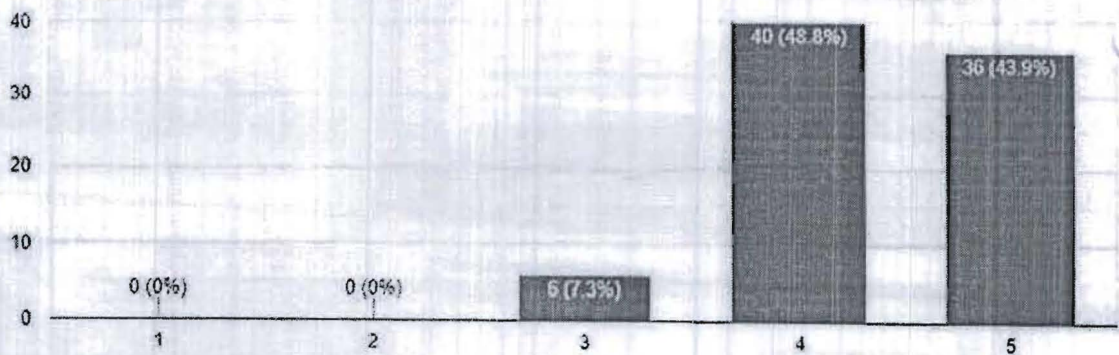

Overall rating of the resource person considering command on the subject matter and delivery : Mr.Stanly Johnson,Topic - Future of Block chain

82 responses

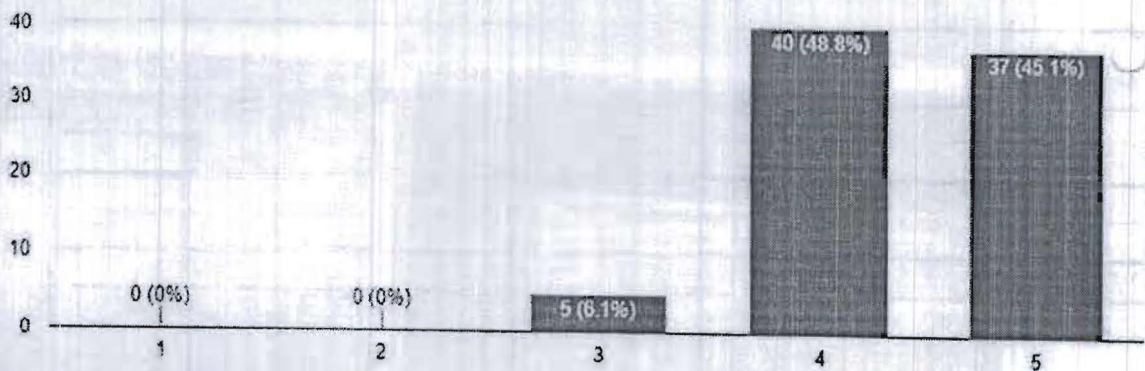



Overall rating of the resource person considering command on the subject matter and delivery : Mr.Stanly Johnson,Topic - Cryptocurrency

82 responses



Overall rating of the resource person considering command on the subject matter and delivery : Mr.Raghu Venkataramana,Topic-IOT- Opportunities,Challenges and Solutions)

82 responses

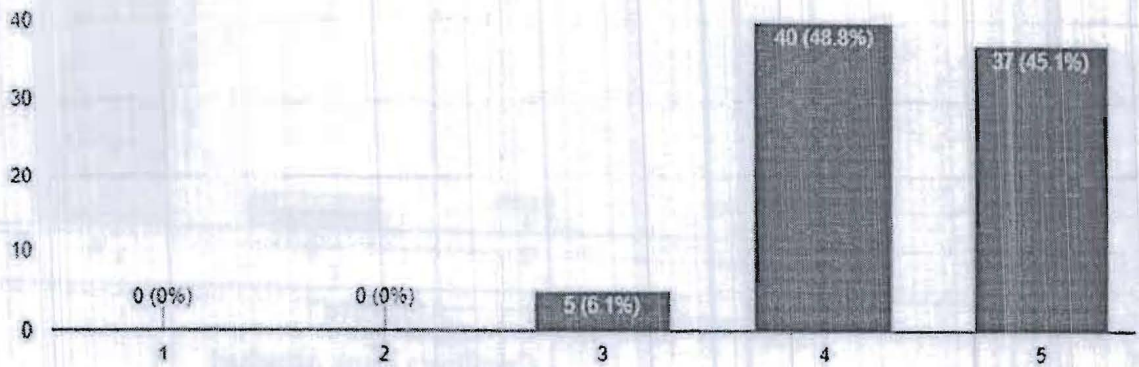

Overall rating of the resource person considering command on the subject matter and delivery : Mr.Gulshan Kumar,Topic - Robotic Process Automation.

82 responses

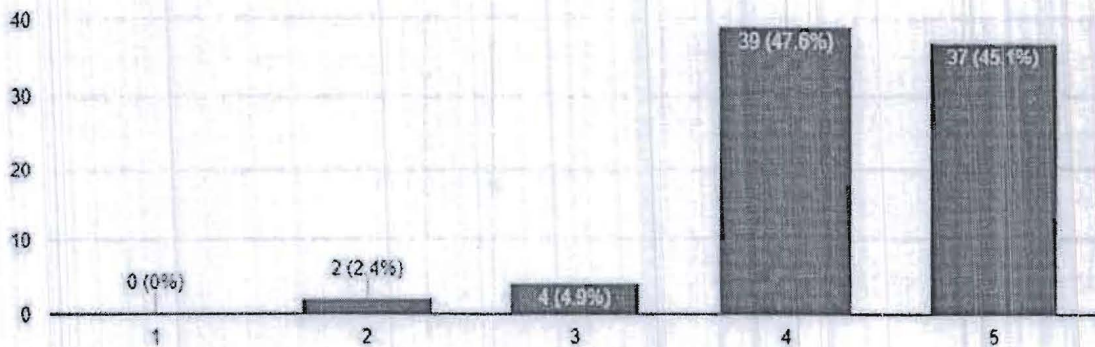



Overall rating of the resource person considering command on the subject matter and delivery : Mr. Mahesh P,Topic- Travel in the Cloud

82 responses

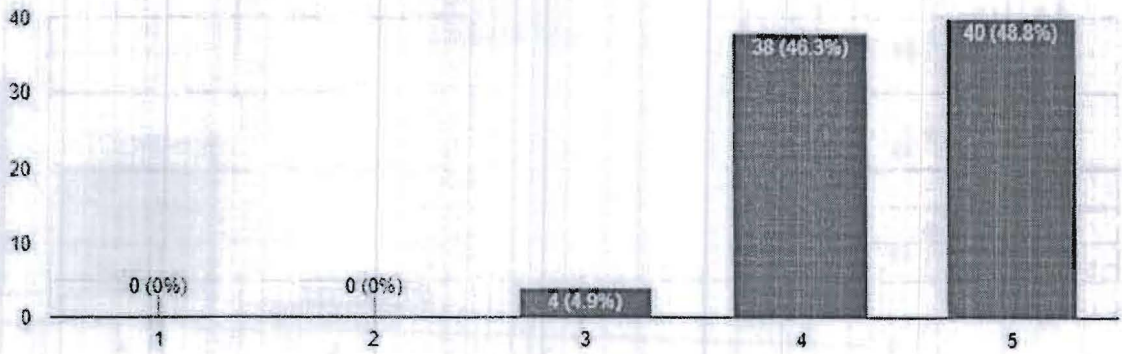

Overall rating on conduct of FDP

82 responses

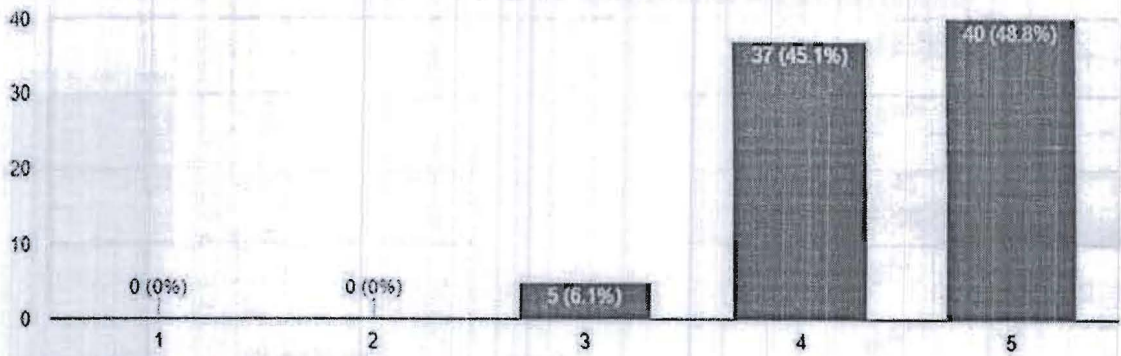

Annexure 7

Certificate Copy Attached





**RV Institute of Management**

Affiliated to Bangalore  
Central University

Approved by AICTE,  
New Delhi. Accredited  
by NAAC with 'A+' grade.



Rastreeya Sikshana Samithi Trust  
**R V Institute of Management**

In association with

**RV-SKILLS**  
CENTER FOR EMERGING  
TECHNOLOGIES



**Certificate of Participation**

This is to certify that,

**Dr.A.Narasima Venkatesh**

has successfully participated in the 6 days FDP on “Emerging Technologies - A Way Forward” organized by R V Institute of Management, in association with RV-SKILLS, Bangalore, from 3<sup>rd</sup> August to 8<sup>th</sup> August, 2020.

**Dr. Purushottam Bung**  
Professor and Director  
R V Institute of Management

**Mr. Venkatesh Prasad**  
CEO, RV-SKILLS





**RV Institute of Management**

Affiliated to Bengaluru Central University

Approved by AICTE, New Delhi. Accredited by NAAC with 'A+' grade.



Rastreeya Sikshana Samithi Trust  
**R V Institute of Management**

In association with

**RV-SKILLS**  
CENTER FOR EMERGING TECHNOLOGIES



**Certificate of Participation**

This is to certify that,

**Dr.G.P Nagesh**

has successfully participated in the 6 days FDP on “Emerging Technologies - A Way Forward” organized by R V Institute of Management, in association with RV-SKILLS, Bangalore, from 3<sup>rd</sup> August to 8<sup>th</sup> August, 2020.

**Dr. Purushottam Bung**  
Professor and Director  
R V Institute of Management

**Mr. Venkatesh Prasad**  
CEO, RV-SKILLS