



FDP on EMERGING TECHNOLOGIES- WAY FORWARD (In association with RV SKILLS)	
Date: 3 rd Aug to 8 th Aug 2020	Venue: Zoom webinar
Time: 11 am to 1 pm	Event : Webinar
No. of Participant: 171	Event Coordinator: Dr. Santhosh M Prof. Reddy Prof Dileep Prof. Priya Jain Ms. Vidya (RV SKILSS)
Objectives <ul style="list-style-type: none">- To gain deeper understanding of the concept of Artificial Intelligence- To identify the future of block chain in India and world.- To understand the concept of IOT and its opportunities and challenges and solutions.- To analyze the importance of Robotics Process Automation in today's world- To examine the future of Cryptocurrency.- To have knowledge about the cloud computing	
Agenda/Flow of the Event <ul style="list-style-type: none">• 3rd Aug- Artificial intelligence by Mr. Chinmaya Mishra, Lead Data Scientist, Microsoft• 4th Aug- Future of Block Chain by Mr. Stanly Johnson, Block Chain developer and researcher• 5th Aug- IOT- opportunities, challenges and solutions by Mr Raghu Venkataramana, Director- Qantom Software Pvt. Ltd.• 6th Aug- Cryptocurrency by Mr. Stanly Johnson, Block Chain developer and researcher• 7th Aug- Robotic Process Automation by Mr. Gulshan kumar, programmer Analyst, Inventys Technology pvt. Ltd.• 8th Aug- Travel in the cloud by Mr. Mahesh P, Infrastructure Engineer Architect, Data management startup.	
Outcome Achieved/ Attained: <ul style="list-style-type: none">- Mr. Chinmaya Mishra started the program on the first day and explained a clear distinction	

between Artificial intelligence, machine Learning and Deep learning. He used CRISP Data Mining Model to solve business problems. He described the use of analytics for recommendations.

- On the second day Mr. Stanly Johnson started the session with the article on Bitcoin: A Peer to Peer Cash System. He explained in detail how block chain functions and what will be the future of block chain.
- Third day session was taken by Mr. Raghu on the topic IOT. He briefly explained what is IOT, its history, opportunities, challenges and solutions. He also told about various application domains of IOT. He showed some videos on the application of IOT for better understanding of participants.
- Fourth day session was taken over by Mr Stanly again on the topic Cryptocurrency. He explained briefly how cryptocurrency works and what is the future of it. He also explained various types of cryptocurrency and motivated audience to invest in same. What are the security points during investment were also very clearly explained by him.
- Fifth day the session was taken over by Mr. Gulshan Kumar on Robotics Process Automation. He explained what is RPA, how it works and various tools of RPA like Blue Prism, Automation Anywhere, UiPath etc. he also explained what should be the selection criterion for the tool.
- Last day session was taken by Mr. Mahesh on Cloud computing. He started the session with quote Travel in the cloud like you travel on the road; travel in the cloud is not just reaching the target but is an experience that you would be excited. He explained about storage of data on the cloud, how it works and various myths associated with it

Feedback & Coordinator Comment:

The entire program was very well received by all the participants. All the participants appreciated the program and were happy to have deeper knowledge on emerging trends. During the sessions participants had a chance to know how various new technologies works and how they can be used in our daily life to solve various problems.

Event Coordinator(s)

M. N. Reddy (Prof. Nagasubba Reddy)
K. P. Sankar (Dr. Santosh M)
Dileep (Prof. Dileep)
Praveen (Prof. Praveen)

~~Director~~

Annexure 1	Proposal / Approval	Attached
Annexure 2	Circular / Brochure of the event	Attached
Annexure 3	Brief profile of the speaker	Attached
Annexure 4	Attendees list	Attached
Annexure 5	Photo Gallery	Attached
Annexure 6	Detail Feedback (if required)	attached
Annexure 7	Certificate copy	attached

Annexure 2
Circular / Brochure of the event
Brochure



RV Institute of Management
Approved by Bangalore Central University
Approved by AICTE, New Delhi. Accredited by NAAC with 'A+' grade

Go, change the world



RV Institute of Management
In association with
RV-SKILLS
CENTRE FOR KNOWLEDGE TECHNOLOGY INNOVATION
Is Organizing an FDP On

“Emerging Technologies- A WAY FORWARD”
From 3rd August to 8th August, 2020
11.00 am to 1.00 pm



SPEAKERS



Chinmaya Mishra
Lead Data Scientist Microsoft
(Topic- Artificial Intelligence)



Gulshan Kumar
Programmer Analyst
Inventys Technology Pvt. Ltd
(Topic - Robotic Process Automation)



Stanly Johnson
Block Chain Developer and Researcher
(Topic-Future of Block Chain and Crypto Currency)



Raghu Venkataramana
Director, Qantom Software Pvt. Ltd.
(Topic-IOT- Opportunities, Challenges and Solutions)



Mr. Mahesh P
Infrastructure Engineer Architect
A Data Management Startup
(Topic- Travel in the Cloud)

Moderator



Mr. Venkatesh Prasad
Professor and Director,
RV SKILLS, Bangalore



Dr. Purushottam Bung
Professor and Director
RV Institute of Management, Bangalore

Participation Fee: Rs. 500/- Faculty / Scholars Rs. 200/- Students

Once you make the payment please register through the google form link
<https://forms.gle/E78e5Bh45vqfMriv9>

E-certificates will be provided to all the registered participants

Payment Details:

Name: Director RV Institute of Management
Bank Name: ICICI Bank, 9th Block Branch,
A/C No.: 029901002291
IFSC Code: ICIC0000299
MICR Code: 560229022
UPI ID : directorrvim@icici



For further clarification please contact:

Dr. Santhosh @ 9739945333
Prof. Reddy @ 9845492336
Prof. Dileep @ 8553276869
Prof. Priya @ 9108300728
Ms. Vidya @ 7349389666

✉ businessanalyst.fdp2020@gmail.com

Annexure 3
Brief profile of the speaker

Brief Profile of the Resources Persons

1. Mr Raghu Venkataramana, Director- Qantom Software Pvt. Ltd.



- Mr. Raghu is the founder and CEO of Qantom Software Private Limited.
- He has done is post graduate in IOT from Birla Institute of Technology and Science, Pilani.
- After working on various technologies like VOIP, Networking, IP Phone etc now he is completely focused on building products and frameworks for IOT Experience.
- Till now he has created many IOT products like prototype of an IOT framework which allows for easy discovery and configuration of IOT end points; a framework to manage unit and automated tests directly from spreadsheets; created a utility which helped Quick test users to manage the descriptive repositories and many more.
- Mr. Raghu is very strong in core java and object oriented development. He is expert in SQA and test automation.
- In his initial years of professional career he has worked in the fields of graphic design and turnkey printing and has build his entrepreneurial skills.

2. Mr. Chinmaya Mishra, Lead Data Scientist, Microsoft



- Mr. Chinmaya is the enthusiastic learner in Artificial Intelligence field with Machine Learning and

Deep learning skills.

- Currently he is leading data science team consists of threat intelligence, hunting, Insider risk and compliance.
- He is a sensible team leader with leading midsize teams and have good record of working closely with cross functional teams across security, operations, marketing and supply chain.
- His passion is mentoring various data science aspirants.
- He loves to explore more in cyber security and Engineering analytics which brought him to work for Fortune 500 companies like Honeywell, Rockwell Collins, Collins Aerospace and Microsoft.
- He has worked on many critical projects like connected ecosystem, cyber security and many more.
- He got an exposure of business aspects of Artificial Intelligence while doing analytics in Retail Finance at Bajaj Auto Finance.
- He is also specialized in Big data technology like Hadoop, R, Python, PYSpark SAS and SPSS

3. Mr. Stanly Johnson, Block Chain developer and researcher



- Mr. Stanly Johnson is a software engineer passionate about developing solutions that make a dent in the universe.
- He has worked on medical block chain platforms; IOT based supply chain solutions, cry exchanges and is an early contributor to the Corda Enterprise block chain platform.
- He is a certified block chain architect and was one of the first employees of Serventire Global. India's first block chain acquisition.
- He currently works as a block chain developer for a leading crypto currency exchange in South korea

4. Mr. Gulshan kumar, programmer Analyst, Inventys Technology pvt. Ltd.

(Full CV attached)

5. Mr. Mahesh P, Infrastructure Engineer Architect, Data management startup.

(Full CV attached)

Annexure 5

Photo Gallery

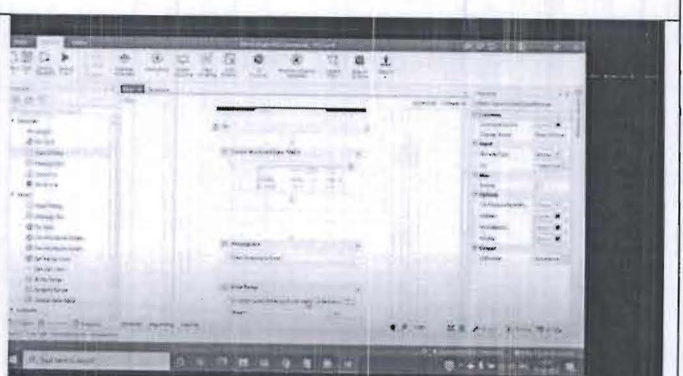
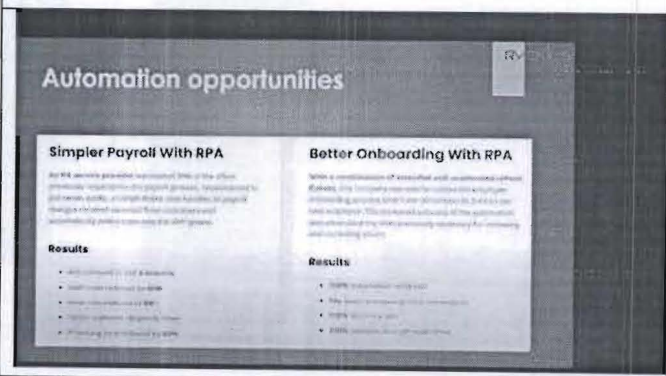
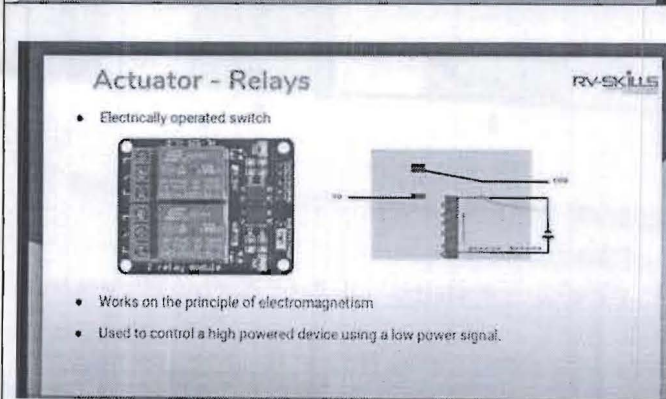
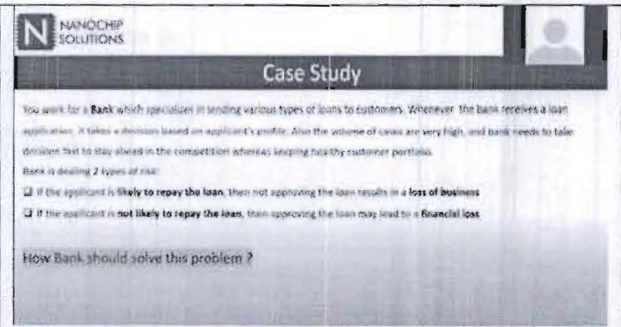
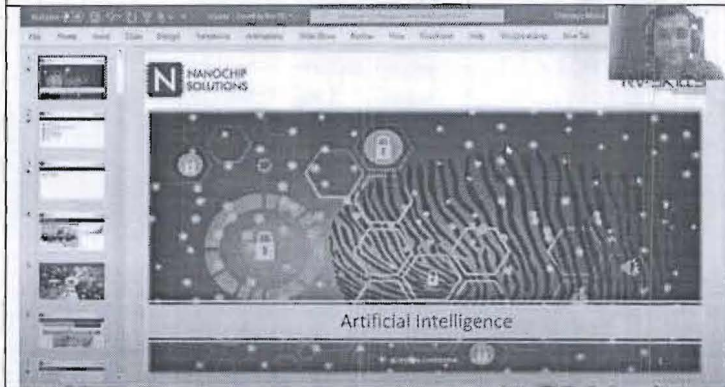

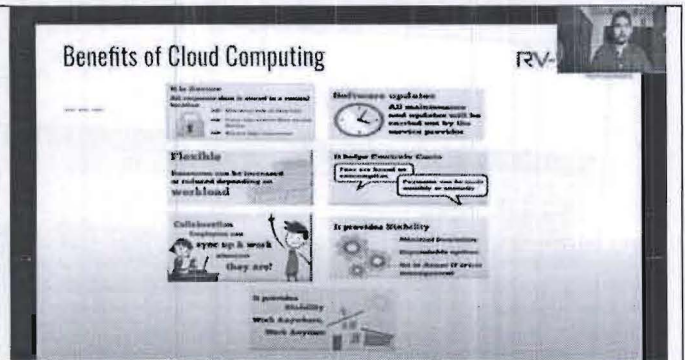
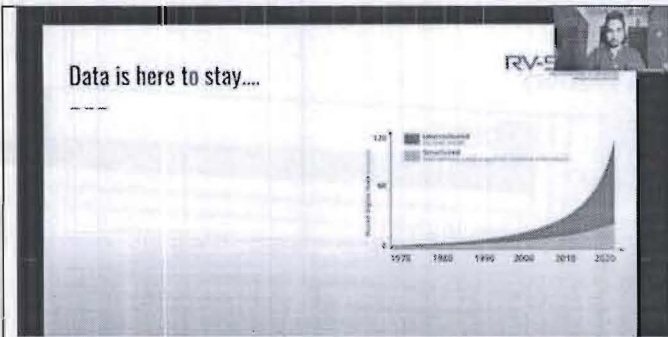

Annexure 6

Detail Feedback

Overall rating of the resource person considering command on the subject matter and delivery : Mr.Chinmaya Mishra,Topic- Artificial Intelligence

82 responses

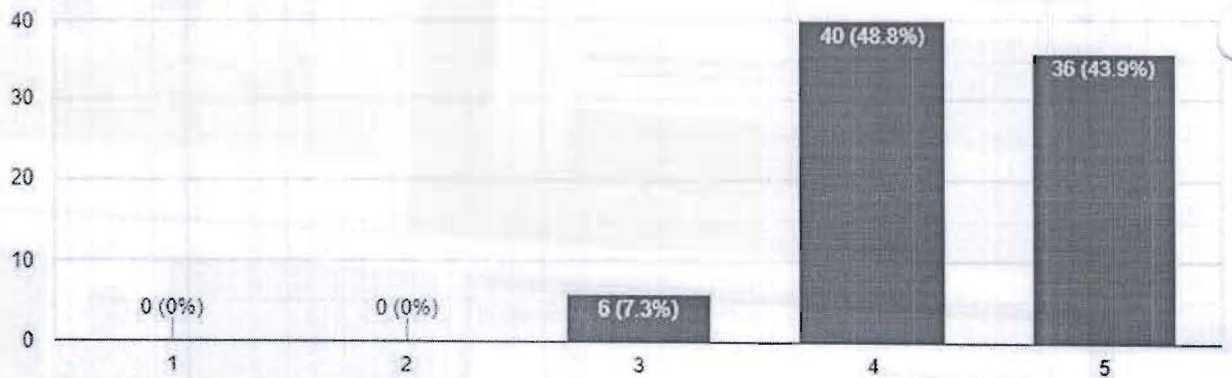

Overall rating of the resource person considering command on the subject matter and delivery : Mr.Stanly Johnson,Topic - Future of Block chain

82 responses

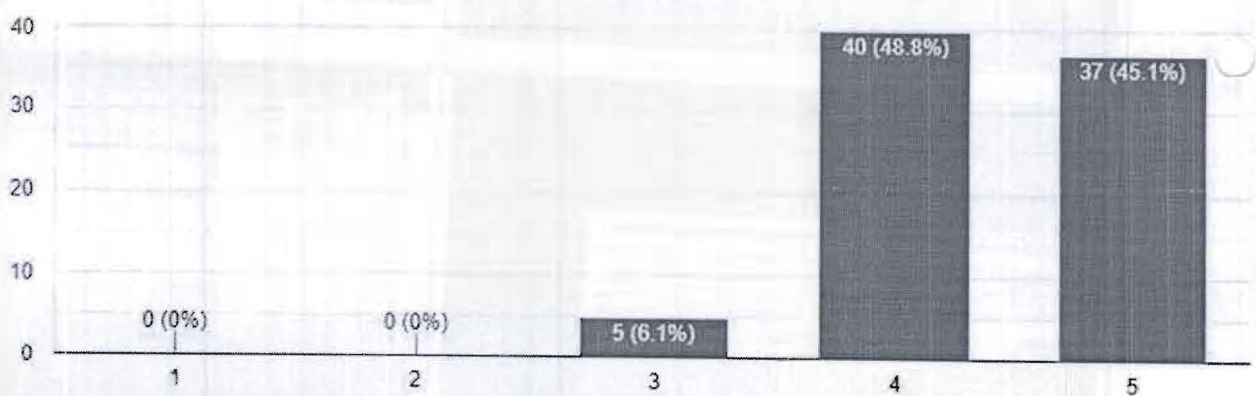

Overall rating of the resource person considering command on the subject matter and delivery : Mr.Stanly Johnson,Topic - Cryptocurrency

82 responses

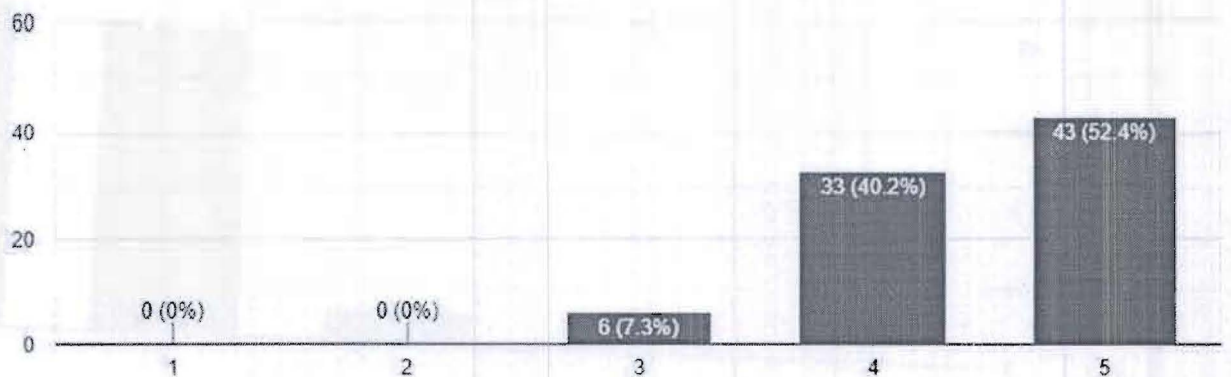

Overall rating of the resource person considering command on the subject matter and delivery : Mr.Raghu Venkataramana,Topic-IOT- Opportunities,Challenges and Solutions)

82 responses

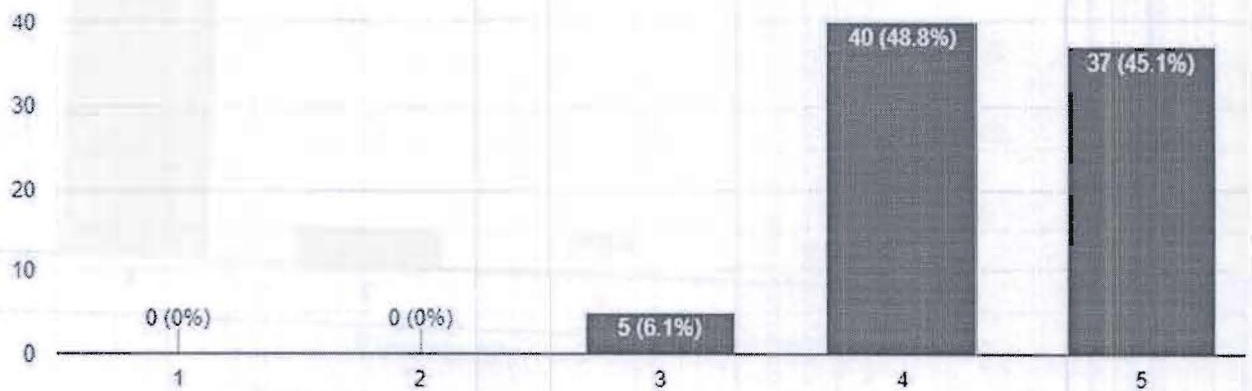

Overall rating of the resource person considering command on the subject matter and delivery : Mr.Gulshan Kumar,Topic - Robotic Process Automation.

82 responses

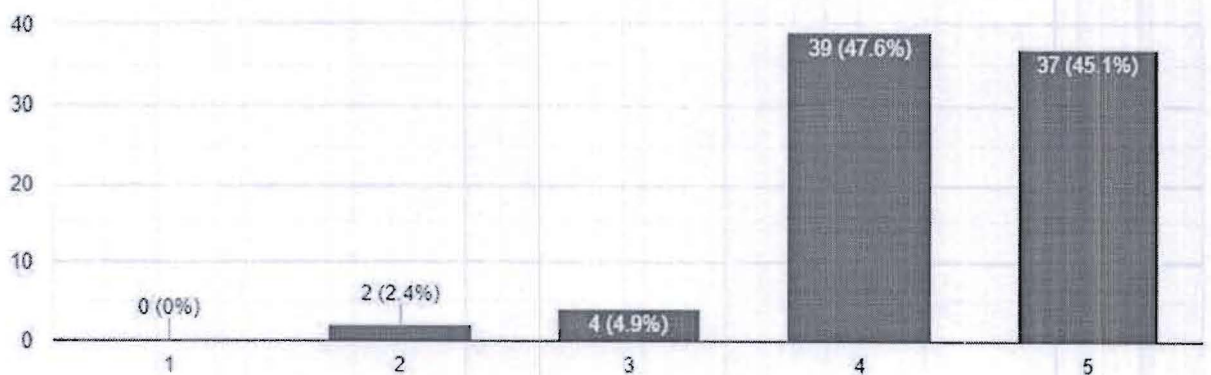

Overall rating of the resource person considering command on the subject matter and delivery : Mr. Mahesh P,Topic- Travel in the Cloud

82 responses

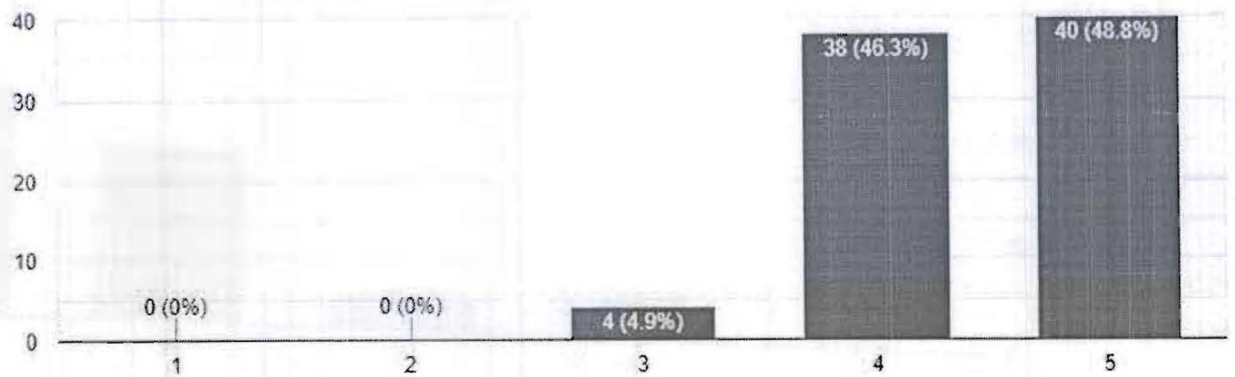

Overall rating on conduct of FDP

82 responses

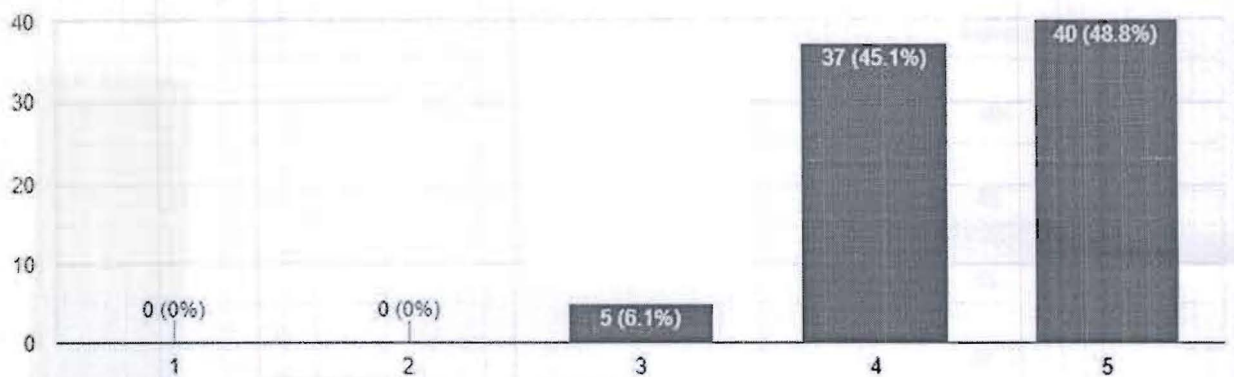

Annexure 7

Certificate Copy Attached

Attendee
Report

Generated: 9/23/2020 16:02

Topic Webinar ID Actual Start Time Actual Duration (minutes) # Registered # Cancelled Unique Viewers Total Users Max Concurrent Views

Emerging
Technologies- A

WAY FORWARD 991 6467 8232 8/3/2020 10:31 173 197 0 171 548 155

Host Details

Attended	User Name (Original Name)	Email	Join Time	Leave Time	Time in Session (minutes)	Country/Region Name
Yes	Priya Jain (Director RVIM)	director.rvim@rvei.edu	8/3/2020 10:31	8/3/2020 13:24	173	India

Panelist Details

Attended	User Name (Original Name)	Email	Join Time	Leave Time	Time in Session (minutes)	Country/Region Name
Yes	Dr. Purushottam Bung	drbung.rvim@rvei.edu	8/3/2020 10:34	8/3/2020 13:24	170	India
Yes	Dr Santhosh	santhoshm.rvim@rvei.	8/3/2020 10:33	8/3/2020 13:24	171	India
Yes	Prof. Reddy	nnsreddy.rvim@rvei.e	8/3/2020 10:43	8/3/2020 13:24	162	India
Yes	Mr. Dileep	dileep.rvim@rvei.edu.i	8/3/2020 10:36	8/3/2020 10:43	8	India
Yes	Mr. Dileep	dileep.rvim@rvei.edu.i	8/3/2020 11:00	8/3/2020 13:24	145	India
Yes	Ms Vidya	vidya@rv-skills.com	8/3/2020 10:35	8/3/2020 13:24	170	India
Yes	Mr. Venkatesh Prasad	vprasad@rv-vlsi.com	8/3/2020 10:43	8/3/2020 12:17	94	India
Yes	Mr. Chinmaya Mishra	chinmaya086@yahoo.	8/3/2020 10:43	8/3/2020 13:24	162	India

Attendee
Details

Attended	User Name (Original Name)	First Name	Last Name	Email	City	Phone	Organization	Registration Time	Approval St
Yes	BALAJI RAJ V T	BALAJI	RAJ V T	balajiyash004@g	BENGALURU	9980582536	R.V Institute C	8/2/2020 18:45	approved
Yes	Bhumika S j	Bhumika	S j	bhumika.shuntika	Bangalore	7337687727	RV institute o	8/3/2020 10:29	approved
Yes	Bhumika S j	Bhumika	S j	bhumika.shuntikatte@gmail.com					
Yes	Bhumika S j	Bhumika	S j	bhumika.shuntikatte@gmail.com					
Yes	Bhumika S j	Bhumika	S j	bhumika.shuntikatte@gmail.com					
Yes	Namrata Kotur	Namrata	Kotur	namratakotur@g	Haveri	9035787315	R.V.INSTITUT	8/2/2020 12:42	approved
No	Ayesha	Ayesha	Banu N	ayashaaye01@g	Bangalore	8660186262	NMKRV colleg	8/3/2020 11:13	approved
Yes	Hanisha Tadavarthy	Hanisha	Tadavarthy	hanishatadavarth	Banglore	8867119968	R V INSTITUTE	8/2/2020 11:56	approved

Attendee Report

Report Generated: 9/23/2020 16:05

Topic	Webinar ID	Actual Start Time	Actual Duration (minutes)	# Registered	# Cancelled	Unique Viewers	Total Users	Max Concurrent Views
Emerging Technologies- A WAY FORWARD	991 6467 8232	8/4/2020 10:29	126	207	0	167	465	160

Host Details

Attended	User Name (Original Name)	Email	Join Time	Leave Time	Time in Session (minutes)	Country/Region Name
Yes	Priya Jain (Director RVIM)	director.rvim@rvei.edu.in	8/4/2020 10:29	8/4/2020 12:35	126	India

Panelist Details

Attended	User Name (Original Name)	Email	Join Time	Leave Time	Time in Session (minutes)	Country/Region Name
Yes	Mr. Stanly Johnson	stanlyjohnson@outlook.com	8/4/2020 10:44	8/4/2020 12:35	111	India
Yes	Dr. Purushottam Bung	drbung.rvim@rvei.edu.in	8/4/2020 10:51	8/4/2020 12:35	104	India
Yes	Dr Santhosh	santhoshm.rvim@rvei.edu.in	8/4/2020 10:48	8/4/2020 12:35	107	India
Yes	Prof. Reddy	nnsreddy.rvim@rvei.edu.in	8/4/2020 10:37	8/4/2020 11:01	24	India
Yes	Prof. Reddy	nnsreddy.rvim@rvei.edu.in	8/4/2020 11:06	8/4/2020 11:08	3	India
Yes	Prof. Reddy	nnsreddy.rvim@rvei.edu.in	8/4/2020 11:08	8/4/2020 12:35	87	India
Yes	Mr. Dileep	dileep.rvim@rvei.edu.in	8/4/2020 10:30	8/4/2020 12:35	125	India
Yes	Ms Vidya	vidya@rv-skills.com	8/4/2020 10:39	8/4/2020 12:35	117	India

Attendee Details

Attended	User Name (Original Name)	First Name	Last Name	Email	City	Phone	Organization	Registration Time	Approval Status	Join Time	Leave Time	Time in Session
Yes	BALAJI RAJ V T	BALAJI RAJ	V T	balajiyash004@gmail.com	BENGALURU	9.98E+09	Institute Of Management	#####	approved	#####	#####	118

Attendee Report

Report

Generated: 9/23/2020 16:06

Topic	Webinar ID	Actual Start Time	Actual Duration (minutes)	# Registered	# Cancelled	Unique Viewers	Total Users	Max Concurrent Views
Emerging Technologies- A WAY FORWARD	991 6467 8232	8/5/2020 10:37	162	210	0	147	435	144

Panelist Details

Attended	User Name (Original Name)	Email	Join Time	Leave Time	Time in Session (minutes)	Country/Region Name
Yes	Dr. Purushottam Bung	drbung.rvim@rvei.edu.in	8/5/2020 11:01	8/5/2020 13:18	138	India
Yes	Dr Santhosh	santhoshm.rvim@rvei.edu.in	8/5/2020 10:41	8/5/2020 13:18	158	India
Yes	Prof. Reddy	nnsreddy.rvim@rvei.edu.in	8/5/2020 10:37	8/5/2020 13:18	162	India
Yes	Mr. Raghu Venkataramana	raghuphone2@gmail.com	8/5/2020 10:37	8/5/2020 13:18	162	India
Yes	Mr. Dileep	dileep.rvim@rvei.edu.in	8/5/2020 10:47	8/5/2020 13:18	152	India
Yes	Ms Vidya	vidya@rv-skills.com	8/5/2020 12:11	8/5/2020 13:18	68	India
Yes	Ms Vidya	vidya@rv-skills.com	8/5/2020 10:38	8/5/2020 12:09	91	India

Attendee Details

Attended	User Name (Original Name)	First Name	Last Name	Email	City	Phone	Organization R.V Institute Of Managem	Registration Time	Approval Status	Join Time	Leave Time
Yes	BALAJI RAJ V T	BALAJI RAJ	V T	balajiyash004@gmail.com	BENGALURU	9.98E+09	ent	#####	approved	#####	#####
Yes	BALAJI RAJ V T	BALAJI RAJ	V T	balajiyash004@gmail.com						#####	#####

Attendee
Report
Report

Generated: 9/23/2020 16:08

Topic	Webinar ID	Actual Start Time	Actual Duration (minutes)	# Registered	# Cancelled	Unique Viewers	Total Users	Max Concurrent Views
Emerging Technologies- A WAY FORWARD	991 6467 8232	8/6/2020 10:27	158	210	0	137	384	128

Host Details

Attended	User Name (Original Name)	Email	Join Time	Leave Time	Time in Session (minutes)	Country/Region Name
Yes	Priya Jain (Director RVIM)	director.rvim@rvei.edu.in	8/6/2020 10:27	8/6/2020 13:04	158	India

Panelist Details

Attended	User Name (Original Name)	Email	Join Time	Leave Time	Time in Session (minutes)	Country/Region Name
Yes	Mr. Stanly Johnson	stanlyjohnson@oulook.com	8/6/2020 10:39	8/6/2020 13:04	145	India
Yes	Dr. Purushottam Bung	drbung.rvim@rvei.edu.in	8/6/2020 11:15	8/6/2020 13:04	110	India
Yes	Dr Santhosh	santhoshm.rvim@rvei.edu.in	8/6/2020 10:54	8/6/2020 13:04	131	India
Yes	Prof. Reddy	nnsreddy.rvim@rvei.edu.in	8/6/2020 10:35	8/6/2020 13:04	149	India
Yes	Mr. Gulshan Kumar	er.gulshankumar2014@gmail.com	8/6/2020 10:35	8/6/2020 13:04	150	India
Yes	Mr. Dileep	dileep.rvim@rvei.edu.in	8/6/2020 10:44	8/6/2020 13:04	141	India
Yes	Ms Vidya	vidya@rv-skills.com	8/6/2020 11:29	8/6/2020 11:46	17	India
Yes	Ms Vidya	vidya@rv-skills.com	8/6/2020 10:33	8/6/2020 11:28	56	India
Yes	Ms Vidya	vidya@rv-skills.com	8/6/2020 12:05	8/6/2020 13:04	60	India

Attendee
Details

Attendee
Report
Report
Generate
d: 9/23/2020 16:09

Topic	Webinar ID	Actual Start Time	Actual Duration (minutes)	# Registered	# Cancelled	Unique Viewers	Total Users	Max Concurrent Views
Emerging Technologies- A WAY FORWARD	991 6467 8232	8/7/2020 10:30	150	210	0	131	287	123

Host
Details

Attended	User Name (Original Name)	Email	Join Time	Leave Time	Time in Session (minutes)	Country/Region Name
Yes	Priya Jain (Director RVIM)	director.rvim@rvei.edu.in	8/7/2020 10:30	8/7/2020 13:00	150	India

Panelist
Details

Attended	User Name (Original Name)	Email	Join Time	Leave Time	Time in Session (minutes)	Country/Region Name
Yes	Dr. Purushottam Bung	drbung.rvim@rvei.edu.in	8/7/2020 10:55	8/7/2020 13:00	126	India
Yes	Dr Santhosh	santhoshm.rvim@rvei.edu.in	8/7/2020 11:01	8/7/2020 13:00	119	India
Yes	Prof. Reddy	nnsreddy.rvim@rvei.edu.in	8/7/2020 10:45	8/7/2020 13:00	135	India
Yes	Mr. Gulshan Kumar	er.gulshankumar2014@gmail.com	8/7/2020 10:35	8/7/2020 13:00	145	India

Attendee Report

Report Generated: 9/23/2020 16:10

Topic	Webinar ID	Actual Start Time	Actual Duration (minutes)	# Registered	# Cancelled	Unique Viewers	Total Users	Max Concurrent Views
Emerging Technologies- A WAY FORWARD	991 6467 8232	8/8/2020 10:24	173	210	0	121	458	113

Host Details

Attended	User Name (Original Name)	Email	Join Time	Leave Time	Time in Session (minutes)	Country/Region Name
Yes	Priya Jain (Director RVIM)	director.rvim@rvei.edu.in	8/8/2020 10:24	8/8/2020 13:16	173	India

Panelist Details

Attended	User Name (Original Name)	Email	Join Time	Leave Time	Time in Session (minutes)	Country/Region Name
Yes	Mr. Mahesh P	mahi.trainer@gmail.com	8/8/2020 10:31	8/8/2020 10:40	10	India
Yes	Mr. Mahesh P	mahi.trainer@gmail.com	8/8/2020 10:40	8/8/2020 13:10	151	India
Yes	Dr. Purushottam Bung	drbung.rvim@rvei.edu.in	8/8/2020 10:30	8/8/2020 13:16	167	India
Yes	Dr Santhosh	santhoshm.rvim@rvei.edu.in	8/8/2020 11:01	8/8/2020 13:14	133	India
Yes	Prof. Reddy	nnsreddy.rvim@rvei.edu.in	8/8/2020 10:47	8/8/2020 13:14	147	India
Yes	Mr. Dileep	dileep.rvim@rvei.edu.in	8/8/2020 10:38	8/8/2020 13:15	157	India
Yes	Ms Vidya	vidya@rvskills.com	8/8/2020 12:21	8/8/2020 12:23	2	India
Yes	Ms Vidya	vidya@rvskills.com	8/8/2020 10:25	8/8/2020 12:23	119	India
Yes	Ms Vidya	vidya@rvskills.com	8/8/2020 12:24	8/8/2020 13:10	47	India
Yes	Mr. Venkatesh Prasad	vprasad@rvvlsi.com	8/8/2020 10:51	8/8/2020 12:04	74	India
Yes	Mr. Venkatesh Prasad	vprasad@rvvlsi.com	8/8/2020 12:45	8/8/2020 13:10	25	India

Attendee Details

Gulshan Kumar

7th Cross,16th main, BTM,2nd Stage, Bengaluru, KA 560076 | 888 048 2405 | er.gulshankumar2014@gmail.com

Professional Summary

Results-oriented RPA developer having 4.8 years' experience in Automation with the web and window-based Applications. Created RPA structure and team along with production support, designed and developed RPA solutions to accelerate Business processes. Flexible and resourceful professional with deep understanding of acceptance criteria.

Skills

- Working Experience with RPA development with UiPath, Blue Prism, Fusion.
- Well acquainted with RPA life cycle, PDD, TDD and OMD
- Experience in creating automation from scratch using UiPath
- Well versed in PDF and Excel automation with UiPath
- Experience with Selectors and Exception handling
- Experience in Email automation with POP, IMAP and Exchange mail services
- Exposure with .net functions for basic UiPath usage
- Exposure to UiPath orchestrator with queues, scheduler and Assets
- Exposure to Blue Prism studio and control room
- Exposure to VBOs and Exception handling in Blue prism
- Experience in Manual and automation testing using selenium web driver
- Experience in Bug life cycle, SDLC and STLC
- Exposure with java and SQL
- Experience with project management tool like JIRA, Bugzilla
- Experience in JMeter and Blaze-meter
- Exposure to GIT, Maven, SVN
- Having strong problem solving and effective communication skills

Work History

RPA Developer

Inventys technology Pvt. Ltd.

Feb 2018 - Current
Bengaluru, KA

Project 1: - Retail Chain Management (Payments):

- **Client** : TGBL
- **Duration** : 10 months
- **Team Size** : 2
- **Technology** : RPA
- **Tools Used** : UiPath, Excel

Description: Main objective of this project was to create documents like Sales order, Delivery challan, and Sales invoices and to manage stock of the company. Source data was being downloaded from a website in the form of excel.

Roles and Responsibilities:

- Adopted Agile methodology for implementation.
- Prepared automation concept and control drawings according to client's specifications.
- Performed needs and gaps analysis procedures and detailed data reviews to optimize implementation.
- Updated and maintained project documentation for detailed recordkeeping.
- Developed technical solutions to resolve a range of problems.
- Discussed requirements and processes with project managers and Client

- Worked with Business Teams to create **PDD (Process Definition Document)** and developed separate **SDD (Solution Design Documents)**
- Created end to end automation with the help of UiPath tool.
- Used Web, PDF, Email, Excel and File automation to develop this process.
- Used UiPath Orchestrator for deployment, monitoring and management of automation.
- Attended daily status call with client, shared status report.

Project 2: - Insurance Claim Management:

- **Client** : Michelin
- **Duration** : 8 months
- **Team Size** : 2
- **Technology** : RPA
- **Tools Used** : UiPath, Sql

Description: Main objective of this project was to update all the settled claims to one portal to another portal based on the dates provided. All the unsettled claims need to be process based on the rules provided by client.

Roles and Responsibilities:

- Adopted Agile methodology for implementation.
- Performed needs and gaps analysis procedures and detailed data reviews to optimize implementation.
- Updated and maintained project documentation for detailed recordkeeping.
- Developed technical solutions to resolve a range of problems.
- Discussed requirements and processes with project managers and Clients.
- Created end to end automation with the help of UiPath tool.
- Used Web, Database, Email, Data-table and File automation to develop this process.
- Used UiPath Orchestrator for deployment, monitoring and management of automation.
- Attended daily status call with client, shared status report.

Project 3: - Supply Chain Management:

- **Client** : Amco
- **Duration** : 8 months
- **Team Size** : 3
- **Technology** : RPA
- **Tools Used** : UiPath, CSV

Description: Main objective of this project was to create invoice based on the data provided in a different portal which will be downloaded into .csv format. We need to read the invoice details and upload it to another portal with unique invoice number.

Roles and Responsibilities:

- Adopted Agile methodology for implementation.
- Performed needs and gaps analysis procedures and detailed data reviews to optimize implementation.
- Updated and maintained project documentation for detailed recordkeeping.
- Developed technical solutions to resolve a range of problems.
- Discussed requirements and processes with project managers and Clients.
- Created end to end automation with the help of UiPath tool.
- Used Web, CSV, Email and File automation to develop this process.
- Used UiPath Orchestrator for deployment, monitoring and management of automation.
- Attended daily status call with client, shared status report.

Project 4: - Ewaybill Creation:

- **Client** : Fleet-Guard

- **Duration** : 4 months
- **Team Size** : 3
- **Technology** : RPA
- **Tools Used** : UiPath

Description: Main objective of this project was to create e-way bill based on the data provided in excel and send a email to client with created e-way bill numbers.

Roles and Responsibilities:

- Adopted Agile methodology for implementation.
- Performed needs and gaps analysis procedures and detailed data reviews to optimize implementation.
- Updated and maintained project documentation for detailed recordkeeping.
- Developed technical solutions to resolve a range of problems.
- Discussed requirements and processes with project managers and Clients.
- Created end to end automation with the help of UiPath tool.
- Used Web, Email and File automation to develop this process.
- Attended daily status call with client, shared status report.

Software Engineer
Exilant Technologies

Oct. 2015 – Feb 2018
Bengaluru, KA

Project 1: - Purchase Control:

- **Client** : Singhvi
- **Duration** : 7 months
- **Team Size** : 5
- **Technology** : RPA
- **Tools Used** : Blue prism, PDF

Description: Main objective of this project to check for the purchase order is in budget or not. Based on that we need to send approval or rejection mails. To check we need to follow certain conditions provided by Client.

Roles and Responsibilities:

- Adopted Agile methodology for implementation.
- Performed needs and gaps analysis procedures and detailed data reviews to optimize implementation.
- Updated and maintained project documentation for detailed recordkeeping.
- Discussed requirements and processes with project managers and Clients.
- Created end to end automation with the help of Blue prism tool.
- Used Web, Email and File automation to develop this process.
- Used Web, Email and file automation using Blue Prism
- Attended daily status call with client, shared status report.

Project 2: - Singapore Postal Services:

- **Client** : Singhvi
- **Duration** : 10 months
- **Team Size** : 8
- **Technology** : Selenium
- **Tools Used** : Selenium Web driver, Java

Description: Singapore Post is a web-based application which has been developed to manage mailing and courier services for the customer based in Singapore.

Roles and Responsibilities:

- Prepared and reviewed scenarios, test cases & test data.
- Designing scenario file for each requirement on basis of manual test cases.

- Created automation test scripts in the existing Hybrid framework.
- Completed automation of functional and regression scenarios.

Project 3: - Performance Evaluation (IO Selas Native):

- **Client** : Singhvi
- **Duration** : 3 months
- **Team Size** : 4
- **Technology** : Performance Testing
- **Tools Used** : JMeter , Blazemeter

Description: IO SELAS is project related to Medical representative. It is used to keep track of meetings, appointments, joining of new medical representatives. This is a native application for apple OS.

Roles and Responsibilities:

- Understand the non-functional requirements from business
- Analyzed the critical business scenarios
- Involved in test Execution, Monitoring and preparing reports
- Involved in analyzing the test result and preparing reports

Project 4: Fusion (RPA Tool):

- **Client** : Internal
- **Duration** : 10 months
- **Team Size** : 10
- **Technology** : Manual Testing, Regression testing, Functional Testing
- **Tools Used** : Jira, Excel

Description: Fusion contains multiple components that help to orchestrate the necessary automation on user's desktop. This is a Internal RPA tool.

Roles and Responsibilities:

- Responsible for writing the test cases and execution of test cases.
- Performed Functionality, System testing, Integration Testing, Smoke Testing.
- Tracked the defects and Prepared User Manual.
- Knowledge management and providing KT to new team member

Education

B.E: Electronics & communication Engineering

Gwalior Institute of Technology (RGTU)

Gwalior

Higher Secondary: Science & Math as specialization

CBSE

Patna, BR

Senior Secondary: Advance mathematics as specialization

CBSE

Patna, BR

Professional Enhancement

- Successfully Completed Certification in Blue prism and UiPath
- Provided training for UiPath and Blue prism

Personal Details

Date of Birth: 10th August,1991

Languages Known: English, Hindi

Mahi Trainer

Infrastructure Engineer & Architect

Personal Info

E-mail

mahi.trainer@gmail.com

Skills

Netapp 7-mode Administration

Netapp C-mode Administration

Netapp C-mode ONTAP 9.0

Performance Troubleshoot

AWS Solutions Architect Associate

I work as an Cloud and Datacenter Architect/Engineer for a large Services firm handling multiple clients in providing Datacenter based Storage/Backup technologies and AWS Cloud solutions. My role includes understanding the client business needs, converting to technical requirements, build a suitable solution, implement and provide L3 troubleshooting.

My expertise on Storage Technologies is majorly Netapp and also EMC to assist with overall issue troubleshooting and provide quick resolution.

Experience

2008 to present

Cloud and Datacenter Engineer/Architect

Current Company

I've trained and provided teaching assistance to hundreds of working professionals through both Online and Corporate Trainings covering Netapp, EMC and VMware technologies. Due to my thorough experience in Datacenter technologies, also added Cloud technology (AWS) to my based and working on the same since last 18 months. Provided training sessions for AWS Solutions Architect Associate.

- 10 years of experience in NETAPP and EMC storage systems architecture, installation, implementation, integration, security and administration in local & Geo-DR remote environments.
- Lead the project for Engineering the solution of 7-mode to C-mode migration and migrating data that included using 7MTT for NAS Volume migrations and WFA for SAN volume migrations.
- Storage Lead for Data Center moves and consolidations for two locations involving 80TB of Netapp storage.
- Troubleshooting and managing CIFS Shares, NFS exports; Qtree and Quotas management.
- Excellent experience in Engineering and Designing the base architecture and configuration, administrating, maintaining and troubleshooting of Netapp FAS and AFF (7-mode and C-mode), EMC-VMAX, EMC-VNX, VPLEX, Isilon and Clariion systems.
- Deployed and configured multiple instances of Storage tools including OCUM, OPM, WFA, 7MTT for Netapp; SYMCLI, SMI-S and Unisphere for VMAX Arrays.
- Lead Engineer/ Architect from developing requirements for Storage and its connected hardware Monitoring/Reporting Alerting tools to creating Design configuration, implementation, setup and support them for Netapp Command Insight and EMC Vopr SRM.
- Good Knowledge of virtualization (VMWare), Install, maintains, and supports VMware (ESX Servers).
- Troubleshoot and resolve the Storage related issues generated in production, Development and testing environments.
- Responsible for providing Engineering Solutions and handling a large Netapp Storage Environment including all protocols, DR, TIER 3 support.
- Responsible for managing different kinds of AFF 8040 and FAS series 6xxx, 3xxx in SAN/NAS environment. Responsible for production support operations for shared and dedicated clients.
- Provide end to end performance troubleshooting and analysis per hour basis when the application teams enquire about slowness.
- Worked on identifying Storage KPI's (capacity, performance and availability) to monitor/report and alert on – defined a RACI model for the same. Integrated OCUM and OPM to setup SNMP alerting.

- Storage Capacity planning to ensure having sufficient headroom for Organic Growth and planned projects and budgeting capacity and upgrades/New installs for future growth based on historical usage and upcoming projects.
- Deployment, Setup and handling ongoing upgrades for new features/enhancements for Netapp monitoring tools including OCUM and OPM.
- Troubleshooted performance issue on Netapp using sysstat output. Generated perfstat on the filer for troubleshooting the Netapp filer performance issues. Enable the VIF interfaces when they are down. Managing takeover and giveback for Active/Active Configuration.

- Professional with 2 years of experience in AWS design, development and cloud implementation.
- Cognitive about designing, deploying and operating highly available, scalable and fault tolerant systems using Amazon Web Services (AWS).
- Extensively worked using AWS services along with wide and in depth understanding of each one of them.
- Highly skilled in deployment, data security and troubleshooting of the applications using AWSservices.
- Proficient in writing Cloud Formation Templates (CFT) in YAML and JSON format to build the AWSservices with the paradigm of Infrastructure as a Code.
- Experienced with event-driven and scheduled AWS Lambda functions to trigger various AWSresources.
- Experienced with installation of AWS CLI to control various AWS services through SHELL/BASH scripting.
- Experienced in writing complex SQL queries and scheduled tasks using cron jobs.
- Good knowledge in relational and NoSQL databases like MySQL, SQLServer, Oracle, DynamoDB, MongoDB.
- Proficient in AWS services like VPC, EC2, S3, ELB, AutoScalingGroups(ASG), EBS, RDS, IAM, CloudFormation, Route 53, CloudWatch, CloudFront, CloudTrail.
- Used security groups, network ACL's, internet gateways and route tables to ensure a secure zone for organization in AWS public cloud.
- Created and configured elastic load balancers and auto scaling groups to distribute the traffic and to have a cost efficient, fault tolerant and highly available environment.
- Created S3 buckets in the AWS environment to store files, sometimes which are required to serve static content for a web application.
- Possess good knowledge in creating and launching EC2 instances using AMI's of Linux, Ubuntu, RHEL, and Windows and wrote shell scripts to bootstrap instance.
- Used IAM for creating roles, users, groups and also implemented MFA to provide additional security to AWS account and its resources.
- Created EBS volumes for storing application files for use with EC2 instances whenever they are mounted to them.
- Experienced in creating RDS instances to serve data through servers for responding to requests.
- Created snapshots to take backups of the volumes and also images to store launch configurations of the EC2 instances.
- Written Templates for AWS infrastructure as a code using Terraform to build staging and production environments.

8/8/2020 13:12:44	Vibha Parmaj	vibhaparmaj9@gmail.com	9845325278	Belgaum	Karnataka	PeopleTree Education Society, Belgaum	I'm waiting for some more FDPs more informative to the passing out students this year from technical background (BCA). N also career opportunities and better domains for career.	Paypal	Cloud Computing	Internet of Things	Robotic Process Automation	Both (1) and (2)	Wallet
8/8/2020 13:12:46	SAIRAMAN SRINIVASAN	saiauro99@gmail.com	9600085724	Chennai	TamilNadu	Consortium For Technical Education	Very thing was well organised.	Litecoin	Cloud Computing	Internet of Things	Robotic Process Automation	Both (1) and (2)	Wallet
8/8/2020 13:12:50	MANJUNATH S K	manjunathsk.rvim@rvei.edu.in	9945578825	Bangalore	Karnataka	RV INSTITUTE OF MANAGEMENT	Very well organised..	Paypal	Remote Invocation	Internet of Things	Robotic Process Automation	Both (1) and (2)	Wallet
8/8/2020 13:12:50	Mohd Zeeshan Athani	zeeshan_athani@rediffmail.com	9731168924	Bengaluru	Karnataka	R.V. Institute of Management	I would like to be a part of a webinar based on affiliate marketing. Sessions can be improved by giving more opportunities to students to interact with the speaker. Overall the sessions are good.	Paypal	Cloud Computing	Internet of Things	Robotic Process Automation	Both (1) and (2)	Bank account
8/8/2020 13:13:15	Dr. Padmalini Singh	singhpadmalini@gmail.com	9019452125	Bangalore	Karnataka	RV Institute of Management	Good choice of Expert Panels	Paypal	Cloud Computing	Internet of Things	Robotic Process Automation	Both (1) and (2)	Wallet
8/8/2020 13:13:32	Shreya Ramachandra	shreyagowda1612@gmail.com	9901056839	Ramanagar	Karnataka	Visvesvaraya technological university	Some more technical terms to be included	Paypal	Cloud Computing	Internet of Things	Robotic Process Automation	Both (1) and (2)	Wallet
8/8/2020 13:13:49	Keerti Patil	Keertipati30@gmail.com	9742473397	Banglore	Karnataka	RVIM	-	Paypal	Cloud Computing	Internet of Things	Robotic Process Automation	Both (1) and (2)	Wallet
8/8/2020 13:13:53	Dr. A. Narasima Venkatesh	dr.a.narasimavenkatesh@gmail.com	9110464380	Bangalore	Karnataka	R V Institute of Management	Very Informative FDP.	Paypal	Cloud Computing	Internet of Things	Robotic Process Automation	Both (1) and (2)	Wallet
8/8/2020 13:14:35	Anupama S. M	anupama219@rediffmail.com	9739697154	Bangalore	Karnataka	R V Institute of Management	No comments	Paypal	Cloud Computing	Internet of Things	Robotic Process Automation	Both (1) and (2)	Wallet
8/8/2020 13:14:50	Sheela hegde	hegadesheela@gmail.com	09663695543	BENGALUR	KARNATAK	RV Institute of management	Nothing	Etherium	Cloud Computing	Internet of Things	Robotic Process Automation	Machine Learning	Bank account
8/8/2020 13:15:01	Akshatha Bopaiah M	akshathabopaiah@gmail.com	08105066141	Kodagu	Karnataka	RV INSTITUTE OF MANAGEMENT	It was good..	Paypal	Cloud Computing	Internet of Things	Robotic Process Automation	Both (1) and (2)	Wallet
8/8/2020 13:15:42	Archana V	archanaanitha1@gmail.com	7204619153	Bangalore	Karnataka	R V Institute of Management	-	Paypal	Cloud Computing	Internet of Things	Robotic Process Automation	Both (1) and (2)	Floppy Disk
8/8/2020 13:15:44	Shivakumar H C	shivakumar.rvim@rvei.edu.in	8147464481	Bengaluru	Karnataka	RV Institute of Management	Wonderfully Organised, No Suggestions	Paypal	Cloud Computing	Internet of Things	Robotic Process Automation	Both (1) and (2)	Wallet
8/8/2020 13:15:46	Deeksha K	deekshak1198@gmail.com	09731549911	Bangalore	KARNATAK	RV Institute of Management	It was very informative.	Bitcoin	Cloud Computing	Internet of Things	Robotic Process Automation	Both (1) and (2)	Wallet
8/8/2020 13:15:59	Sowmya D S SUBRAMANYA	sowmyads.rvim@rvei.edu.in	9740165784	Bangalore	Karnataka	R V Institute of Management	Pis share the reading materials and recordings of the FDP	Paypal	Cloud Computing	Internet of Things	Robotic Process Automation	Both (1) and (2)	Wallet
8/8/2020 13:16:14	G	subramanyagovindaraj7@gmail.com	9844649626	DAVANGER	KARNATAK	GMIT	Nothing	Paypal	Cloud Computing	Internet of Things	Robotic Process Automation	Both (1) and (2)	Wallet
8/8/2020 13:16:57	Ashwathi Sundaram	ashwathisundaram16@gmail.com	+918861491005	Bangalore	Karnataka	RV Institute of Management	Good job.	Paypal	Cloud Computing	Internet of Things	Robotic Process Automation	Both (1) and (2)	Wallet
8/8/2020 13:17:16	Akshatha Bopaiah M	akshathabopaiah@gmail.com	08105066141	Kodagu	Karnataka	RV INSTITUTE OF MANAGEMENT	The session was very knowledgable.	Paypal	Cloud Computing	Internet of Things	Robotic Process Automation	Both (1) and (2)	Wallet
8/8/2020 13:17:27	Nikita L	nikitalohi49@gmail.com	8762568272	Bangalore	Karnataka	RV Institute of Management Bangalore	Well presented by the entire panel	Paypal	Cloud Computing	Internet of Things	Robotic Process Automation	Both (1) and (2)	Wallet

8/8/2020 13:18:32	Tejashwini S	tejashwini.shivu29@gmail.com	9945727583	Bangalore	Karnataka	RV Institute of Management	-	Litecoin	Cloud Computing	Internet of Things	Robotic Process Automation	Both (1) and (2)	Wallet
8/8/2020 13:18:36	Dr. G. P. Nagesh	gpnagesh27@gmail.com	9110692983	Shivamogga	Karnataka	Kuvempu university	Some core finance topics blend of technology support may be taken.	Paypal	Remote Sensing	Internet of Things	Robotic Process Automation	Both (1) and (2)	Bank account
8/8/2020 13:19:01	Smeeta Patil	smeetakpatil07@gmail.com	7259816967	Ron	Karnataka	R V Institute of Management	Over all it was good it was knowledgeable session.	Paypal	Cloud Computing	Internet of Things	Robotic Process Automation	Both (1) and (2)	Wallet
8/8/2020 13:19:35	Deena k	deenakrishna97@gmail.com	9844245971	Hassan	Karnataka	RV Institute of Management		Paypal	Cloud Computing	Internet of Things	Robotic Process Automation	Both (1) and (2)	Wallet
8/8/2020 13:20:10	Sandeshsavak S	sandeshsavak@gmail.com	9900276843	Bangalore	Karnataka	RV Institute of Management	No	Litecoin	Cloud Computing	Internet of Things	Robotic Process Automation	Both (1) and (2)	Wallet
8/8/2020 13:20:11	Nikitha Sreekantha	nikithasreekantha74@gmail.com	9886434746	Bangalore	Karnataka	Dayananda Sagar Business Academy	Professionally organised FDP. Excellent Moderators. Hats off to Dr. Bung & Team	Paypal	Cloud Computing	Internet of Things	Robotic Process Automation	None of the above	Wallet
8/8/2020 13:21:20	Lathashree S	lathashree31@gmail.com	9741354577	Bangalore	Karnataka	R V INSTITUTE OF MANAGEMENT	It was informative session	Paypal	Cloud Computing	Internet of Things	Robotic Process Automation	Both (1) and (2)	Wallet
8/8/2020 13:22:40	Hanisha Tadavarthy	hanishatadavarthy98@gmail.com	8867119968	Banglore	Karnataka	R V INSTITUTE OF MANAGEMENT	No	Paypal	Cloud Computing	Internet of Things	Robotic Process Automation	Both (1) and (2)	Wallet
8/8/2020 13:23:36	Ganapati Janardhan Bhat	rganapati6@gmail.com	8150906458	Kumta	Karnataka	R V Institute of Management		Paypal	Cloud Computing	Internet of Things	Robotic Process Automation	Both (1) and (2)	Wallet
8/8/2020 13:23:47	Amarnath P M	amarnathpujarim@gmail.com	+918499957729	Hindupur	Andhra Pradesh	R V INSTITUTE OF MANAGEMENT		Paypal	Cloud Computing	Internet of Things	Robotic Process Automation	Both (1) and (2)	Wallet
8/8/2020 13:25:31	B Vasavi	bvasavisweety@gmail.com	8904517892	Hindupur	Andhra Pradesh	RV institute of management	None	Paypal	Cloud Computing	Internet of Things	Robotic Process Automation	Both (1) and (2)	Wallet
8/8/2020 13:25:56	Sushmitha D.R	sushmitharamanath@gmail.com	9740109400	Bangalore	Karnataka	RV institute of management		Paypal	Cloud Computing	Internet of Things	Robotic Process Automation	Both (1) and (2)	Wallet
8/8/2020 13:26:13	Arun Raveendra Bhat	aranbhat.bhat@gmail.com	08277612604	Bangalore	Karnataka	R V Institute of Management	Nothing	Paypal	Cloud Computing	Internet of Things	Robotic Process Automation	Both (1) and (2)	Wallet
8/8/2020 13:26:25	Deepak Desai	deepakdesai511@gmail.com	7795784815	Hospet	Karnataka	RV institute of management	No suggestions its good	Paypal	Cloud Computing	Internet of Things	Robotic Process Automation	Both (1) and (2)	Wallet
8/8/2020 13:27:12	Shravya S Shetty	shettyshravya1996@gmail.com	9867151007	Mumbai	Maharashtra	R V Institute of Management	More case studies	Paypal	Cloud Computing	Internet of Things	Robotic Process Automation	Both (1) and (2)	Bank account
8/8/2020 13:29:49	Akshatha M L	akshatham26@gmail.com	9739071231	Sagar	Karnataka	RV institute of management of	I want some more sessions on analytics, iot	Paypal	Cloud Computing	Internet of Things	Robotic Process Automation	Both (1) and (2)	Wallet
8/8/2020 13:31:08	Dr (Brig) Sandes	principal@dsba.edu.in	9886434746	Bangalore	Karnataka	Dayananda Sagar Business Academy	Please avoid 2nd Saturday, Atleast 1 day should have resource person from Abroad. Introduction should be minimum. Overall good.	Paypal	Cloud Computing	Internet of Things	Robotic Process Automation	None of the above	Wallet
8/8/2020 13:34:39	Sandesh Shridhar Shet	sandeshshet01@gmail.com	9743857897	Honnavar	Karnataka	R V INSTITUTE OF MANAGEMENT	Provide more FDPs on management	Paypal	Cloud Computing	Internet of Things	Robotic Process Automation	Both (1) and (2)	Wallet
8/8/2020 13:38:11	Chiraag M	chiraagm2020@gmail.com	7349734948	Banglore	Karnataka	R v institute of Management	No suggestion it was very helpful	Paypal	Cloud Computing	Internet of Things	Robotic Process Automation	Both (1) and (2)	Wallet
8/8/2020 13:39:16	Thejasvi N	thejasvinitk@gmail.com	+919738663055	Banglore	Karnataka	R V INSTITUTE OF MANAGEMENT	Nil	Paypal	Cloud Computing	Internet of Things	Robotic Process Automation	Both (1) and (2)	Wallet

Timestamp	Name of the Participant (To be printed in the certificate)	Email id	Contact number	City	State	Name of the School/University/Institute/Corporate House	Your suggestions for improving future FDPs	Which of the following is not a Cryptocurrency?	is a paradigm of distributed computing to provide the customers on-demand, utility based computing service.	What is the full form of IOT?	What is the full form of RPA?	Which of the following are comprised within AI?	Where do you store your cryptocurrency?
8/4/2020 16:06:19													
8/8/2020 12:16:14	Nagasubba Reddy	nnsreddy.rvim@rvei.edu.in	9845492336	Bangalore	Karnataka	RVIM	Excellent	Bitcoin	Cloud Computing	Internet of Things	Robotic Process Automation	Both (1) and (2)	Bank account
8/8/2020 13:01:41	Sowjanya Bhat B	sowjanyaabhat1997@gmail.com	8970115118	Bangalore	Karnataka	R V Institute of Management	Nothing	Paypal	Cloud Computing	Internet of Things	Robotic Process Automation	Both (1) and (2)	Bank account
8/8/2020 13:02:27	Karthik N D	n.dkarthik98@gmail.com	7259129933	Bangalore	Karnataka	R V Institute of Management	None	Paypal	Cloud Computing	Internet of Things	Robotic Process Automation	Both (1) and (2)	Bank account
8/8/2020 13:03:05	Arpitha s	sarpitha975@gmail.com	9739694599	Bangalore	Karnataka	RVIM	wonderful session	Paypal	Cloud Computing	Internet of Things	Robotic Process Automation	Both (1) and (2)	Bank account
8/8/2020 13:03:09	Shreya Satish Deshpande	shreyadeshpande1998@gmail.com	8967220512	Bangalore	Karnataka	RV Institute of Management	None	Paypal	Cloud Computing	Internet Operational Thing	Robotic Process Automation	Both (1) and (2)	Bank account
8/8/2020 13:03:23	Shiva Prasad Dr	search4shivassp@gmail.com	8105885854	Pavagada	Karnataka	Rv institute of management	Overall good and interactive sessions, no need of change, just go with this flow and educate the public, learned many things Thanks a lot Director sir..	Paypal	Cloud Computing	Internet of Things	Robotic Process Automation	Both (1) and (2)	Wallet
8/8/2020 13:03:34	Mahesha.S	maheshas2694@gmail.com	+918861573232	Bangalore	Karnataka	RV INSTITUTE OF MANAGEMENT	Looking forward for more such webinars	Paypal	Cloud Computing	Internet of Things	Robotic Process Automation	Both (1) and (2)	Wallet
8/8/2020 13:03:49	Varja Madhuranath	varjamadhuranath1996@gmail.com	9900347057	Bangalore	Karnataka	R V Institute of Management	-	Etherium	Cloud Computing	Internet of Things	Robotic Process Automation	Machine Learning	Wallet
8/8/2020 13:04:26	Lokesh MG	arunlokes98@gmail.com	8217036546	Bangalore	Karnataka	R V Institute of Management	Include more programs	Paypal	Cloud Computing	Internet of Things	Robotic Process Automation	None of the above	Bank account
8/8/2020 13:04:49	Sandesh Shridhar Shet p	sandeshshet01@gmail.com	9743857897	Honnavar	Karnataka	RV INSTITUTE OF MANAGEMENT	It's good session	Paypal	Cloud Computing	Internet of Things	Robotic Process Automation	Both (1) and (2)	Wallet
8/8/2020 13:05:01	Ramya R	ramyaraju3698@gmail.com	9742189513	Bangalore	Karnataka	Rv institute of management		Paypal	Cloud Computing	Internet Operational Thing	Robotic Process Automation	Both (1) and (2)	Floppy Disk
8/8/2020 13:05:21	UdayaRaviKanth KV	udayravi9urk@gmail.com	0	Bangalore	Karnataka	RV INSTITUTE OF MANAGEMENT	Very nice session	Paypal	Cloud Computing	Internet of Things	Robotic Process Automation	Both (1) and (2)	Wallet
8/8/2020 13:05:51	Karan SK	karansk38@gmail.com	8660199195	Hassan	Karnataka	RV Institute of Management		Paypal	Cloud Computing	Internet of Things	Robotic Process Automation	Both (1) and (2)	Wallet
8/8/2020 13:06:17	Sravanthi T	sravanthitatineni04@gmail.com	9632899669	Ballari	Karnataka	RV INSTITUTE OF MANAGEMENT	Nothing	Paypal	Cloud Computing	Internet of Things	Robotic Process Automation	Both (1) and (2)	Wallet
8/8/2020 13:06:18	Mahesha.S	maheshas2694@gmail.com	+91886157323	Bangalore	Karnataka	RV INSTITUTE OF MANAGEMENT	Looking forward for more such webinars	Paypal	Cloud Computing	Internet of Things	Robotic Process Automation	Both (1) and (2)	Wallet
8/8/2020 13:06:53	Sainath Vinayak Kulkarni	sainathkulkarni97@gmail.com	9611964405	Bengaluru	Karnataka	RV Institute Of Management	It was a good sessions	Paypal	Cloud Computing	Internet of Things	Robotic Process Automation	Both (1) and (2)	Floppy Disk
8/8/2020 13:06:54	PAVITHRA S T	pavithrast.rvim@rvei.edu.in	9902165590	Bangalore	Karnataka	R V Institute of Management	GOOD	Paypal	Cloud Computing	Internet of Things	Robotic Process Automation	Both (1) and (2)	Wallet
8/8/2020 13:07:04	Shreya Ramachandra	shreyagowda1612@gmail.com	9901056839	Ramanagar	Karnataka	Visvesvaraya technological university	Little focus towards technical terms	Paypal	Cloud Computing	Internet of Things	Robotic Process Automation	Both (1) and (2)	Wallet
8/8/2020 13:07:07	Dr. Shilpa Ajay	shilpa.ajay@nmit.ac.in	9900447462	Bangalore	Karnataka	Nitte Meenakshi Institute of Technology	Good session	Paypal	Cloud Computing	Internet of Things	Robotic Process Automation	Both (1) and (2)	Wallet

8/8/2020 13:07:18	Keerthan Kamath	keerthan.kamath.45@gmail.com	7760418092	Kundapur	Karnataka	R.V Institute of Management on	No suggestions	Paypal	Remote Invocation	Internet of Things	Robotic Process Automation	Both (1) and (2)	Wallet
8/8/2020 13:07:24	Ramya S	ramyas.rvim@rvei.edu.in	9741849806	Bangalore	Karnataka	RV Institute of Management	Great FDP	Paypal	Cloud Computing	Internet of Things	Robotic Process Automation	Both (1) and (2)	Wallet
8/8/2020 13:07:48	Syed Asif Pasha	pashasif30@gmail.com	7019048592	Bangalore	Karnataka	R V Institute Of Management	More such FDPs on emerging technologies and specifically on Blockchain technology	Paypal	Cloud Computing	Internet of Things	Robotic Process Automation	Both (1) and (2)	Wallet
8/8/2020 13:08:18	Kuberanand N	Kuberakushi007@gmail.com	9945464538	Bangalore	Karnataka	Rv institute of management	It was gud	Paypal	Cloud Computing	Internet of Things	Robotic Process Automation	Both (1) and (2)	Wallet
8/8/2020 13:08:19	Karthik M	7karthik.m@gmail.com	9900741401	Bengaluru	Karnataka	RV Institute of Management	Thanks for Team RVIM	Paypal	Cloud Computing	Internet of Things	Robotic Process Automation	Both (1) and (2)	Wallet
8/8/2020 13:08:24	Prajna Pramanik	prajnapramanik98@gmail.com	8482017955	Bangalore	Karnataka	R V Institute of Management	Grateful to have such opportunities.	Paypal	Remote Sensing	Internet of Things	Robotic Process Automation	Both (1) and (2)	Wallet
8/8/2020 13:08:54	Shreya Shahapurkar	shahapurkar.shreya123@gmail.com	+918867145075	Jayanagar	Karnataka	R V institute of Management Bangalore	Great sessions	Paypal	Cloud Computing	Internet of Things	Robotic Process Automation	Both (1) and (2)	Wallet
8/8/2020 13:09:50	MUZAMMIL RIHAN	MUZZ007SHAIK@GMAIL.COM	8073626891	HUBBALLI	KARNATAKA	RV INSTITUTE OF MANAGEMEN T	All the suggestions gave me the idea and in depth of all the topics, THANKS to RVIM	Etherium	Cloud Computing	Internet of Things	Robotic Process Automation	Both (1) and (2)	Wallet
8/8/2020 13:09:50	Divyashree R	divyashree131298@gmail.com	7899919317	Bangalore	Karnataka	RV Institute of Management	No suggestions, these sessions were good and sufficient.	Paypal	Cloud Computing	Internet of Things	Robotic Process Automation	Both (1) and (2)	Wallet
8/8/2020 13:11:26	Bharath Kiran DV	bharathdvmurthy21@gmail.com	7676423766	Bangalore	Karnataka	R V Institute of Management	Thankyou for the opportunity, we are now exposed to other emerging technologies and can step explore more on the area of interest.	Paypal	Cloud Computing	Internet of Things	Robotic Process Automation	Both (1) and (2)	Wallet
8/8/2020 13:11:43	Bindu Priya	bindupriyasmdc@gmail.com	8123337714	Bellry	Karnataka	R V Institute of management	It was overall knowledgeable session	Paypal	Cloud Computing	Internet of Things	Robotic Process Automation	Both (1) and (2)	Wallet
8/8/2020 13:11:52	MALLIKARJUN.J	mallikarjunj6589@gmail.com	8884544018	Bengaluru	Karnataka	R V INSTITUTE OF MANAGEMEN T	Sessions are very much technical and a bit hard for commerce students, just attended because it was done mandatory.	Paypal	Cloud Computing	Internet of Things	Robotic Process Automation	Both (1) and (2)	Wallet
8/8/2020 13:11:56	chetan vijay	chetanvijay98@gmail.com	08884067776	Bangalore	karnataka	r v institute of management	n	Paypal	Remote Invocation	Internet Object Training	Robotic Process Automation	Deep Learning	Floppy Disk
8/8/2020 13:12:14	Nikhil K	nikhilnike131999@gmail.com	9739413285	Bangalore	Karnataka	R V Institute of Management	FDP was very interesting and informative and useful	Bitcoin	Cloud Computing	Internet of Things	Robotic Process Automation	Both (1) and (2)	Wallet
8/8/2020 13:12:19	Vidya V T	vidyavenut@gmail.com	8494915915	Bangalore	Karnataka	RV INSTITUTE OF MANAGEMEN T	Not sure	Etherium	Cloud Computing	Internet of Things	Robotic Process Automation	Both (1) and (2)	Bank account

8/8/2020 13:41:17	N B GOWTAMI	nbgowtami.naik18@gmail.com	8861821518	Sirsi, Uttar	Karnataka	RV INSTITUTE OF MANAGEMENT	Inclusion of more real time examples.	Paypal	Cloud Computing	Internet of Things	Robotic Process Automation	Both (1) and (2)	Wallet
8/8/2020 13:41:35	Salman pasha	salu2230@gmail.com	8618774474	Bangalore	Karnataka	Bangalore central university	had a great insights about the emerging technologies and bit more interactive	Paypal	Cloud Computing	Internet of Things	Robotic Process Automation	Both (1) and (2)	Wallet
8/8/2020 13:50:59	Dileep Satish Hegde	dileephegde1997@gmail.com	8105123488	Siddapur	Karnataka	RV Institute of Management		Paypal	Cloud Computing	Internet of Things	Robotic Process Automation	Both (1) and (2)	Wallet
8/8/2020 13:55:33	Srivalli N Gupta	srivalli21gupta@gmail.com	9845869343	Mysore	Karnataka	RV institute of management	It was good	Paypal	Remote Invocation	Internet of Things	Robotic Process Automation	Both (1) and (2)	Wallet
8/8/2020 14:09:24	Reshma subray Hegde	reshheg.21@gmail.com	9481940957	Sirsi	Karnataka	Rv institute of management Bangalore	No suggestions	Paypal	Remote Sensing	Internet of Things	Robotic Process Automation	Both (1) and (2)	Floppy Disk
8/8/2020 14:18:46	Yashaswini H.K	yashuhulimane@gmail.com	8762791799	Banglore	Karnataka	R V Institute of management	Nothing	Etherium	Cloud Computing	Internet of Things	Robotic Process Automation	Both (1) and (2)	Floppy Disk
8/8/2020 14:38:08	Clinton Joyan Roche	clintan_r@outlook.com	9844630217	Bangalore	Karnataka	R. V. Institute of Management	Make it such that all the participants would be able to interact.	Bitcoin	Cloud Computing	Internet of Things	Robotic Process Automation	Both (1) and (2)	Wallet
8/8/2020 14:41:38	Prajeeth A Goutham	prajeethgoutham@gmail.com	9738309068	Mysuru	Karnataka	RVIM	-	Paypal	Cloud Computing	Internet of Things	Robotic Process Automation	Both (1) and (2)	Wallet
8/8/2020 14:42:47	Suprita S Chatni	supchatni@gmail.com	+918884788664	Hubli	Karnataka	R V Institute Of Management, Bangalore	No suggestions	Paypal	Cloud Computing	Internet of Things	Robotic Process Automation	Both (1) and (2)	Wallet



RV Institute of Management®

Affiliated to Bengaluru Central University.

Approved by AICTE, New Delhi. Accredited by NAAC with A+ grade.

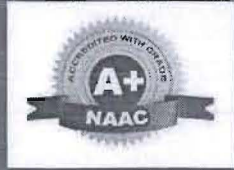

Rastreeya Sikshana Samithi Trust
R V Institute of Management

In association with

RV-SKILLS
CENTER FOR EMERGING TECHNOLOGIES



Certificate of Participation

This is to certify that,

Dr. Shilpa Ajay

has successfully participated in the 6 days FDP on “Emerging Technologies - A Way Forward” organized by R V Institute of Management, in association with RV-SKILLS, Bangalore, from 3rd August to 8th August, 2020.

Dr. Purushottam Bung
Professor and Director
R V Institute of Management

Mr. Venkatesh Prasad
CEO, RV-SKILLS



RV Institute of Management®

Affiliated to Bangalore Central University

Approved by AICTE, New Delhi. Accredited by NAAC with 'A+' grade.



Rastreeya Sikshana Samithi Trust
R V Institute of Management

In association with

RV-SKILLS
CENTER FOR EMERGING TECHNOLOGIES

Certificate of Participation

This is to certify that,

Dr.G.P Nagesh

has successfully participated in the 6 days FDP on “Emerging Technologies - A Way Forward” organized by R V Institute of Management, in association with RV-SKILLS, Bangalore, from 3rd August to 8th August, 2020.

Dr. Purushottam Bung
Professor and Director
R V Institute of Management

Mr. Venkatesh Prasad
CEO, RV-SKILLS



RV Institute of Management®

Affiliated to Bengaluru Central University

Approved by AICTE, New Delhi. Accredited by NAAC with 'A+' grade.

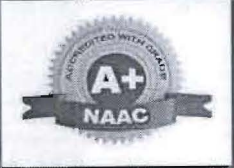

Rastreeya Sikshana Samithi Trust
R V Institute of Management

In association with

RV-SKILLS
CENTER FOR EMERGING TECHNOLOGIES



Certificate of Participation

This is to certify that,

Dr.A.Narasima Venkatesh

has successfully participated in the 6 days FDP on “Emerging Technologies - A Way Forward” organized by **R V Institute of Management**, in association with **RV-SKILLS**, Bangalore, from 3rd August to 8th August, 2020.

Dr. Purushottam Bung
Professor and Director
R V Institute of Management

Mr. Venkatesh Prasad
CEO, RV-SKILLS